



MANIAS
HORECA

RESTAURANT

HOTEL

MEPRA
S.p.A.

IL NOSTRO LAVORO

Dal 1947 il nostro lavoro è quello di produrre posate e altri articoli in acciaio per la ristorazione, usando solamente i migliori materiali e prestando la massima cura alle finiture.

Combinando l'esperienza maturata nel settore delle forniture alberghiere con il gusto per il design, rivolto alle più raffinate boutique di lista nozze e articoli per la casa, abbiamo sviluppato, accanto ai prodotti tradizionali, una serie di prodotti innovativi e di avanguardia, che seguono le nuove tendenze della moda e della ristorazione.

Il presidio diretto della produzione, nel nostro stabilimento di Lumezzane, ci consente, inoltre, di soddisfare le esigenze dei nostri clienti che richiedono particolari personalizzazioni (finiture, design, marchi)

I nostri collaboratori ed il nostro reparto ricerca e sviluppo sono a vostra disposizione per qualsiasi richiesta.



OUR JOB

Since 1947, our mission has been to design and manufacture flatware and holloware using only the finest materials and finishing techniques. With over sixty years of professional foodservice industry experience coupled with modern utilitarian design we offer a complete range of innovative and contemporary products that are in step with the latest trends.

Our products are designed and made in Italy in our own factory. We have complete control over the design and manufacturing process and therefore can offer our customers unparalleled service and the utmost quality assurance. Furthermore, through our in-house Research and Development team we offer our customers personalized fabrication including product design, special finishing, logos, etc. to meet our customers' unique requirements. Please contact us for further details.

NOTRE TRAVAIL

Depuis 1947 notre travail est de produire des couverts et autres articles en acier pour les restaurants, en employant seulement les meilleurs matériaux et en prêtant le plus grand soin aux finitions.

En combinant l'expérience mûrie dans le secteur des fournitures hôtelières et le goût pour le design engagé à des boutiques de liste des noces et articles pour la maison, nous avons développé auprès des produits traditionnels une série de produits innovants et d'avant-garde qui suivent les nouvelles tendances de la mode et des hôtels/restaurants.

La ligne directe de la production de notre établissement de Lumezzane, permet en outre de satisfaire les exigences de nos clients qui demandent des détails personnalisés (finitions, design, marque)

Nos collaborateurs et notre studio recherche et développement, sont à votre disposition pour toute demande.



UNSERE BERUFUNG

Seit 1947 produzieren wir Bestecke & Servierteile, die mittels sorgfältigster Fertigungstechnik und unter Verwendung bester Materialien hergestellt werden. Durch unseren hohen Anspruch an Geschmack und Design, kombiniert mit 60-jähriger Produktionserfahrung, sind wir kompetenter Lieferant bester Design-Shops und Spezialgeschäfte rund um den Erdball. Die logische Folge unserer Philosophie und Qualifikation ist jenes umfangreiche Sortiment innovativer und zeitgenössischer Produkte, die die neusten Trends im Hotel- und Restaurantbusiness wiedergeben. Als typisches Merkmal italienischer Hersteller produzieren wir nicht nur in bestem Design und Qualität, sondern erfüllen in maximaler Flexibilität individuelle Kundenwünsche, wie z. B. individuelle Finishing, Logos und Designvarianten). Diesbezüglich kontaktieren Sie einfach unsere jeweiligen Vertriebspartner oder unsere zentrale Entwicklungsabteilung und beschreiben Ihre Vorstellungen, Wünsche und Fragen.

NUESTRO TRABAJO

Desde el 1947 nuestro trabajo es producir cubiertos y otros artículos de acero para la restauración, empleando solamente los mejores materiales y prestando el cuidado más grande a los acabados.

Combinando la experiencia madurada en el sector de los abastecimientos hoteleros y el gusto para el design de las tiendas de lista de las bodas y los artículos para la casa, hemos desarrollado con los productos tradicionales una serie de productos innovativos y de vanguardia que siguen las nuevas tendencias de la moda y de los hoteles / restaurantes.

La línea directa de la producción de nuestro establecimiento de Lumezzane, permite satisfacer las exigencias de nuestros clientes que piden detalles personalizados (acabados, diseño, marca)

Nuestros colaboradores y nuestro estudio técnico, están a su disposición para todas las peticiones.



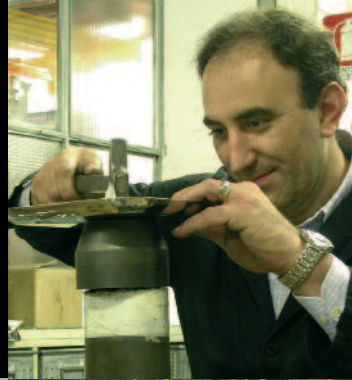

DESIGN



PRODUZIONE



TRADIZIONE



- 1 Tutti i materiali rispondono alla normativa riguardante il contatto con gli alimenti
- 1 Acciaio inossidabile 18/10 di altissima qualità
- 1 Policarbonato infrangibile
- 1 Polipropilene e policarbonato adatti al microonde
- 1 Tutti i prodotti sono garantiti per il lavaggio in lavastoviglie

- 1 All materials used are in accordance with laws governing food and beverages
- 1 Only the highest quality 18/10 gauge stainless steel is used
- 1 Top grade polycarbonate used for ultra clear quality and indestructible performance
- 1 Polypropylene and polycarbonate is microwave safe
- 1 All items are dishwasher safe

- 1 Tous les matériels répondent à la normative concernant le contact avec les aliments
- 1 Acier inoxydable 18/10 de haute qualité
- 1 Policarbonate incassable
- 1 Polipropilene et policarbonate aptes aux micro-ondes
- 1 Tous les produits sont garantis pour le lavage en lave-vaisselle

- 1 Alle verwendeten Materialien entsprechen den gesetzlichen Anforderungen bezüglich der Sicherheit des Kontakts mit Lebensmitteln
- 1 18/10 Chromnickelstahl höchster Qualität
- 1 Unzerbrechliches Polycarbonat
- 1 Polycarbonat und Polypropylen sind mikrowellenfest
- 1 Alle Produkte sind spülmaschinenfest

- 1 Todos los materiales responden a la normativa con respecto al contacto con los alimentos.
- 1 Acero inoxidable 18/10 de alta calidad
- 1 Policarbonato irrompible
- 1 Polipropileno y policarbonato apto para microondas
- 1 Todos los productos están garantizados para el lavado en lava-vajillas



- 1 Tutti gli articoli, incluso il vasellame, possono essere personalizzati con logo a richiesta, mediante incisione laser o punzonatura, senza quantità minima

- 1 All items can be personalized (company name, logo, etc.) using laser engraving or stamping technology. No minimum quantity is required.

- 1 Tous les articles, inclus la vaisselle, ils peuvent être personnalisés avec du logo à la demande, par gravure laser ou poinçonnage, sans quantité moindre

- 1 Alle Produkte, einschließlich die für den Hausgebrauch, können nach Wunsch mit einer Lasergravur oder anderen Beschriftung mit eigenem Logo versehen werden; eine Mindestmenge dafür ist nicht vorgeschrieben.

- 1 Todos los artículos, incluso las bandejas, pueden ser personalizadas con logo sobre demanda, mediante grabado al láser o a estampación, sin cantidad mínima.

FINITURE - FINISHING - FINISSAGES - OBERFLACHEFINISH - FINICIONES

ICE

I Tutti gli articoli, incluso il vasellame, possono essere prodotti anche con superficie satinata.

I All items can be manufactured with matt finish surface.

I Tous les articles, inclus la vaisselle, ils peuvent être produit avec surface satinée.

I Alle Produkte, einschließlich die für den Hausgebrauch, können nach Wunsch mit matten Finish hergestellt werden.

I Todos los artículos, incluso las bandejas, pueden ser producidos con superficie satinada.

ORO - ORO ICE - ORO NERO - BRONZO - CHAMPAGNE - ARCOBALENO

Il rivestimento è realizzato in P.V.D. (Physical Vapor Deposition). Questa tecnologia ha origini nel campo spaziale per aumentare la resistenza dei pannelli esterni delle navicelle spaziali e nella gioielleria. Grazie alla collaborazione con primarie università italiane, siamo la prima azienda ad applicare queste finiture di diverse tonalità di colore. Le caratteristiche delle finiture sono idonee all'utilizzo nel settore alberghiero, nel campo della ristorazione.

The surface treatment is a P.V.D. process (Physical Vapour Deposition) This technology was developed for the aeronautic industry and is used to shield NASA's Space Shuttle panels against corrosion and to protect fine jewelry. In co-operation with renowned Italian Universities we were the first to apply

these treatments in order to achieve original color tonalities. The characteristics of these treatments are hard wearing and hospitality grade - ideal for distinctive hotels, restaurants and catering services.

Le revêtement est réalisé en P.V.D. (Physical Vapor Deposition). Cette technologie a origines dans le champ spatial pour augmenter la résistance des panneaux extérieurs des nacelles spatiales et dans la bijouterie. La collaboration avec universités italiennes primaires nous sommes la première usine à appliquer ces finitions de différentes tonalités de couleur.

Les caractéristiques des finitions sont aptes à la jouissance dans le secteur hôtelier, dans le camp de la restauration.



Die Oberflächenbehandlung des Bestecks ist ein P.V.D. Prozess (Physikalisches Dampf-Absetzungsverfahren).

Diese Technologie ist für die Raumfahrtindustrie entwickelt worden und wird dazu benötigt, die stark beanspruchten Flügel von Weltraumfähren widerstandsfähiger zu machen, aber auch für hochwertigen Schmuck und wertvolle Armbanduhren.

In Kooperation mit Forschungsabteilungen italienischer Hochschulen und Universitäten haben wir innovative Verfahren entwickelt, die es ermöglichen, nie dagewesene Farbtöne für Bestecke und Edelstahlaccessoires zu erreichen. Die widerstandsfähigen und hygienischen Eigenschaften bleiben.

El revestimiento esta realizado con P.V.D. (Physical Vapor Deposition) Esta tecnología original del campo espacial, se utiliza para aumentar la resistencia de los paneles exteriores de las naves espaciales y en joyería. Gracias a la colaboración de la principal universidad italiana, somos la primera empresa en aplicar esta terminación en diversas tonalidades de color. La características de estas terminaciones, son idóneas para su utilización en el sector hostelero, y de la restauración.

SILVER-PLATED

Argentatura tramite processo galvanico con tecnologia d'avanguardia

Produzione soggetta a severi controlli qualitativi di:

quantità di argento depositato

perfetta aderenza del deposito sulla superficie

Spessore maggiorato nei punti di maggiore usura

Superiore resistenza alla graffiatura

Usare sempre prodotti specifici per la pulizia dell'argento



Silver Plating is produced by the most technologically advanced galvanic process.

The production of silver plated items is controlled with special attention to the quantity of silver and the quality of adhesion.

Thickness of silver is higher in those areas of higher wear.

Highly scratch resistant.

Silver cleaning products are recommended for maintaining the investment.

Argentage par procès galvanique avec technologie d'avant-garde

Production sujette aux contrôles qualitatifs sévères de:

quantité d'argent déposé

adhérence parfaite du dépôt sur la surface

Épaisseur augmentée dans les points de grande usure r

Résistance supérieure à la griffure

On recommande de nettoyer les objets seulement avec des produits spécifiques pour l'argent.

Die Versilberung führen wir mittels eines galvanischen Prozesses durch, der dem allerneuesten Stand der Technik entspricht.

Die Produktion versilberter Teile wird u.a. wie folgt kontrolliert:
Genaueste Messung der Menge des verwendeten Silbers
Ausgezeichnete Adhäsion der Versilberung auf den jeweiligen Oberflächen der Teile

Die Stärke der Silberbeschichtung wird bei den Teilen an den Stellen (z.B. Auflageflächen, Zinken) erhöht, wo die Abnutzung am größten ist.
Höhere Widerstandsfähigkeit gegen Abnutzungsverschleiss
Zur Reinigung empfehlen wir besonderen Silber Reinigungsmitteln zu verwenden.

Plateado con proceso galvanico y con tecnología de vanguardia
Producción sujeta a un severo control de calidad:



Cantidad de plata depositada
perfecta adherencia del deposito sobre la superficie
Espesor mejorado en los puntos de mayor uso
Superior resistencia al rallado
Se encomienda limpiar solo con productos especificos para la plata.

Posate



FLATWARE COUVERTS BESTECKE CUBIERTOS

- Gamma completa per ogni modello
- Spessore elevato
- Rebbi delle forchette lavorati internamente
- Seghettatura lame passante per un taglio perfetto

- Each collection consists of an extensive range of pieces.
- Thick stainless steel.
- Fork tines are polished on all sides for a lifetime of performance.
- Knife blades have a micro-serration for an effortless cut.

- Chaque modèle est complet de toute le pièces nécessaire
- Épaisseur massifs
- Fourchons des fourchettes intérieurement travaillés
- Les couteaux possèdent la dentelure fin ouvragée pour une coupe facile

- Jedes Modell verfügt über eine komplette Bandbreite an Zusatzteilen
- Hohe Materialstärke
- Exakte, maschinell gefertigte Gabelzinken
- Genauste Ausbildung der Messerschneiden für einen perfektem Schnitt

- Cada modelo esta completo de todo lo necesario
- Espesor macizo
- Tenedores con púas pulidas internamente.
- Cuchillos con hoja sierra; corte perfecto

MEPRA
S.p.A.



Code	mm.	inch.
01	199	7 7/8
02	199	7 7/8
03	228	9
04	176	6 7/8
05	176	6 7/8
06	203	8
07	135	5 3/8
08	108	4 1/8
09	330	13
10	235	9 1/4
11	235	9 1/4
12	228	9
13	203	8
15	150	5 7/8
16	251	9 7/8
20	195	7 5/8
21	195	7 5/8
22	235	9 1/4
23	235	9 1/4
25	185	7 1/4
35	175	6 7/8
36	228	9
37	170	6 3/4
39	175	6 7/8
40	185	7 1/4
45	183	7 1/5

Coltelli disponibili anche con manico vuoto
 Hollow handle knives available
 Couteaux disponibles aussi avec un manche creux
 Messer in Hohlheft-Ausführung erhältlich
 Cuchillo disponible también en mango hueco

mm 4,0
ACQUA



Code	mm.	inch.
01	201	7 7/8
02	201	7 7/8
03	227	9
04	180	7
05	180	7
06	202	8
07	139	5 1/2
08	110	4 1/3
09	295	11 2/3
10	243	9 1/2
11	243	9 1/2
15	145	5 3/4
16	243	9 1/2
20	210	8 1/4
21	192	7 1/2
22	243	9 1/2
23	243	9 1/2
35	180	7
36	227	9
37	161	6 1/3
39	180	7
40	175	6 7/8
45	203	8

Tutti i pezzi di questo modello sono realizzati in forgia
 All pieces in this range are forged
 Toutes les pièces de ce modèle sont forgées
 Alle Teile dieses Modells sind geschmiedet.
 Todas las piezas de este modelo son hechas en forgia



Code	mm.	inch.
01	208	8 1/5
02	208	8 1/5
03	235	9 1/4
04	185	7 1/4
05	185	7 1/4
06	205	8
07	140	5 1/2
08	120	4 3/4
09	275	10 7/8
10	250	9 7/8
11	250	9 7/8
15	155	6
16	260	10 1/4
20	210	8 1/4
21	185	7 1/4
22	250	9 7/8
23	250	9 7/8
25	201	7 9/8
35	185	7 1/4
36	235	9 1/4
37	183	7 3/5
39	185	7 1/4
40	180	7
45	183	7 1/4

I coltelli appoggiano sulla lama
 Knives may be set blade-down
 Les couteaux peuvent être posés debout sur leurs lames
 Durch das aussergewöhnliche Design, ist es möglich, die
 jeweiligen Messer auch hochkant, also "auf der Klinge
 stehend", abzustellen.
 Los cuchillos pueden apoyar sobre la hoja.

Tutti i pezzi di questo modello sono realizzati in forgia
 All pieces in this range are forged
 Toutes les pièces de ce modèle sont forgées
 Alle Teile dieses Modells sind geschmiedet
 Todas las piezas de este modelo son hechas en forgia

mm 8,0 **ARTE**



Code	mm.	inch.
01 	210	8 1/4
02 	208	8 1/5
03 	235	9 1/4
04 	190	7 1/2
05 	188	7 2/5
06 	212	8 1/3
07 	138	5 2/5
08 	109	4 1/3
09 	289	11 1/3
10 	240	9 1/2
11 	238	9 2/5
15 	157	6 1/6
16 	259	10 1/3
20 	223	8 3/4
21 	208	8 1/5
22 	240	9 1/2
23 	240	9 1/2
25 	208	8 1/5
36 	233	9 1/6
37 	178	7
39 	192	7 1/2
40 	170	6 2/3



Code	mm.	inch.
01	200	7 7/8
02	202	8
03	221	8 3/4
04	180	7
05	180	7
06	198	7 3/4
07	135	5 1/3
08	114	4 1/2
09	312	12 1/8
10	235	9 1/4
11	240	9 1/2
15	150	5 7/8
16	255	10
20	210	8 1/4
21	202	8
22	235	9 1/4
23	235	9 1/4
25	185	7 1/4
31	114	4 1/2
35	180	7
36	221	8 3/4
37	162	6 1/2
39	180	7
40	185	7 1/4



ICE

mm 4,0

AVANGUARDIA



Code		mm.	inch.
01		204	8
02		204	8
03		245	9 2/5
04		176	7
05		176	7
06		220	8 2/5
07		135	5 1/5
08		111	4 2/5
09		313	12 1/5
10		253	10
11		253	10
12		245	9 2/5
13		220	8 2/5
15		154	6
16		241	9 1/2
20		209	8 1/5
21		207	8 1/7
22		253	10
23		253	10
26		164	6 1/2
35		175	6 7/6
36		245	9 2/5
37		169	6 2/5
39		175	6 7/6
40		187	7 1/5
45		192	7 1/2

Coltelli disponibili anche con manico vuoto
 Hollow handle knives available
 Couteaux disponibles aussi avec un manche creux
 Messer in Hohlheft-Ausführung erhältlich
 Cuchillo disponible también en mango hueco



Code	mm.	inch.
01 	209	8 1/5
02 	209	8 1/5
03 	235	9 1/4
04 	180	7
05 	180	7
06 	204	8
07 	135	5 1/3
08 	114	4 1/2
09 	315	12 2/5
10 	250	9 7/8
11 	250	9 7/8
12 	235	9 1/4
13 	204	8
15 	155	6
16 	243	9 1/2
20 	210	8 1/4
21 	207	8 1/7
22 	250	9 7/8
23 	250	9 7/8
24 	140	5 1/2
25 	195	7 2/3
26 	155	6
35 	180	7
36 	224	8 4/5
37 	170	6 2/3
39 	180	7
40 	184	7 1/4
44 	165	6 1/2
45 	208	8 1/6

Coltelli disponibili anche con manico vuoto
 Hollow handle knives available
 Couteaux disponibles aussi avec un manche creux
 Messer in Hohlheft-Ausführung erhältlich
 Cuchillo disponible también en mango hueco

mm 3,0
BOHEME



01		204	8
02		203	8
03		232	9 1/8
04		185	7 1/4
05		184	7 1/4
06		210	8 1/4
07		134	5 1/4
08		110	4 1/3
09		288	11 1/3
10		240	9 2/5
11		241	9 1/2
15		158	6 1/5
16		258	10
20		198	7 4/5
21		184	7 1/4
35		182	7 1/6
36		234	9 1/5
37		172	6 3/4



Code		mm.	inch.
01		207	8 1/8
02		207	8 1/8
03		244	9 3/5
04		179	7
05		179	7
06		219	8 3/5
07		135	5 1/3
08		114	4 1/2
09		320	12 3/5
10		250	9 5/6
11		250	9 5/6
12		244	9 3/5
13		219	8 3/5
15		157	6 1/6
16		243	9 1/2
17		242	9 1/2
18		258	10
19		250	9 5/6
20		212	8 1/3
21		206	8 1/3
22		250	9 5/6
23		250	9 5/6
35		180	7
36		225	8 5/6
37		174	6 7/6
39		179	7
40		188	7 2/5

Coltelli disponibili anche con manico vuoto
 Hollow handle knives available
 Couteaux disponibles aussi avec un manche creux
 Messer in Hohlheft-Ausführung erhältlich
 Cuchillo disponible también en mango hueco

mm 3,0
CELLINI



Code	mm.	inch.
01	206	8 1/8
02	206	8 1/8
03	240	9 2/5
04	178	7
05	178	7
06	214	8 2/5
07	133	5 1/4
08	113	4 2/5
09	315	12 2/5
10	245	9 2/5
11	245	9 2/5
12	240	9 2/5
13	214	8 2/5
15	155	6
16	241	9 1/2
20	210	8 1/4
21	206	8 1/8
22	240	9 2/5
23	244	9 3/5
25	208	8 1/6
26	156	6 1/7
35	178	7
36	240	8 1/8
37	169	6 2/5
39	178	7
40	183	7 1/5
44	165	6 1/2
45	177	7



PELTRO

Coltelli disponibili anche con manico vuoto
 Hollow handle knives available
 Couteaux disponibles aussi avec un manche creux
 Messer in Hohlheft-Ausführung erhältlich
 Cuchillo disponible también en mango hueco



Code	mm.	inch.
01	200	7 7/8
02	200	7 7/8
03	225	8 7/8
04	175	6 8/9
05	180	7
06	200	7 7/8
07	135	5 1/3
08	110	4 1/3
09	298	11 3/4
10	235	9 1/4
11	245	9 2/3
15	150	6
16	252	10
20	185	7 1/4
21	185	7 1/4
22	235	9 1/4
23	235	9 1/4
25	185	7 1/4
35	180	7
36	225	8 5/8
37	193	7 3/5
39	178	7
40	180	7
45	189	7 2/5

- ICE
- ORO
ICE
- ORO
NERO
- BRONZO
- CHAMPAGNE
- ARCOBALENO

mm 4,0
DUE



Code		mm.	inch.
01		205	8
02		206	8 1/8
03		235	9 1/4
04		175	6 8/9
05		175	6 8/9
06		202	8
07		134	5 1/4
08		111	4 1/3
09		302	11 8/9
10		231	9
11		233	9 1/6
15		157	6 1/6
16		241	9 1/2
20		184	7 1/4
21		175	6 8/9
22		231	9
23		231	9
36		235	9 1/4
37		175	6 8/9
39		175	6 8/9
40		173	6 4/5



Code		mm.	inch.
01		203	8
02		200	7 7/8
03		220	8 2/3
04		178	7
05		185	7 1/4
06		195	7 2/3
07		135	5 1/3
08		113	4 2/5
09		310	12 1/5
10		245	9 2/3
11		241	9 1/2
15		150	5 8/9
16		255	10
20		197	7 3/4
21		185	7 1/3
22		245	9 2/3
23		245	9 2/3
25		201	8
35		178	7
36		220	8 2/3
37		195	7 2/3
39		178	7
40		180	7

mm 4,0

ENERGIA



Code		mm.	inch.
01		209	8 1/5
02		209	8 1/5
03		240	9 1/2
04		180	7
05		180	7
06		214	8 2/5
07		136	5 1/3
08		114	4 1/2
09		315	12 2/5
10		250	9 7/8
11		250	9 7/8
12		240	9 1/2
13		214	8 2/5
15		155	6
16		243	9 1/2
20		210	8 1/4
21		207	8 1/7
22		250	9 7/8
23		250	9 7/8
35		190	7 1/2
36		227	9
37		172	6 3/4
39		180	7
40		184	7 1/4
44		165	6 1/2
45		208	8 1/6



Coltelli disponibili anche con manico vuoto
 Hollow handle knives available
 Couteaux disponibles aussi avec un manche creux
 Messer in Hohlheft-Ausführung erhältlich
 Cuchillo disponible también en mango hueco



Code		mm.	inch.
01		205	8
02		200	7 7/8
12		215	8 2/5
04		193	7 3/5
05		178	7
13		192	7 1/2
07		138	5 2/5
09		293	11 1/2
10		249	9 4/5
11		249	9 4/5
15		172	6 3/4
16		252	10
20		211	8 1/5
21		204	8
40		201	7 8/5

Coltelli disponibili anche con manico pieno.
 Solid handle knives available.
 Couteaux disponibles aussi avec un manche plein.
 Auch Monoblock- Messer erhältlich.
 Cuchillo disponible también en mango lleno.



Angelo Mangiarotti

Tutti i pezzi di questo modello sono realizzati con manico vuoto.
 All the pieces in this range are realized with hollow handle.
 Toutes les pièces de ce modèle sont réalisées avec les manches vides.
 Alle Teile dieses Modells sind in Hohlheft-Ausführung verarbeitet.
 Todas las piezas de este modelo son hechas a mango hueco.

mm 3,0

ERGONOMICA



Code	mm.	inch.
01	210	8 1/4
02	210	8 1/4
03	234	9 1/5
04	190	7 1/2
05	187	7 1/3
06	208	8 1/5
07	142	5 3/5
08	120	4 3/4
09	300	11 4/5
10	255	10
11	250	9 5/6
15	160	6 1/3
16	280	11
20	212	8 1/3
21	186	7 1/3
22	255	10
23	255	10
25	195	7 2/3
35	188	7 2/5
36	234	9 1/5
37	198	7 4/5
39	190	7 1/2
40	191	7 1/2
45	193	7 3/5

I coltelli appoggiano sulla lama
 Knives may be set blade-down
 Les couteaux peuvent être posés debout sur leurs lames
 Durch das aussergewöhnliche Design, ist es möglich, die
 jeweiligen Messer auch hochkant, also "auf der Klinge
 stehend", abzustellen.
 Los cuchillos pueden apoyar sobre la hoja.

Tutti i pezzi di questo modello sono realizzati in forgia
 All pieces in this range are forged
 Toutes les pièces de ce modèle sont forgées
 Alle Teile dieses Modells sind geschmiedet
 Todas las piezas de este modelo son hechas en forgia



Code		mm.	inch.
01		214	8 2/5
02		214	8 2/5
03		247	9 3/4
04		189	7 2/5
05		189	7 2/5
06		218	8 3/5
07		144	5 2/3
08		116	4 1/2
09		300	11 4/5
10		256	10
11		256	10
15		156	6 1/7
16		274	10 3/4
20		212	8 1/3
21		189	7 2/5
22		256	10
23		256	10
36		247	9 3/4
37		218	8 3/5
44		165	6 1/2



ADV
Astier de Villatte

mm 3,0

GINEVRA



Code		mm.	inch.
01		195	7 2/5
02		195	7 2/5
03		218	8 3/5
04		173	6 4/5
05		173	6 4/5
06		195	7 2/5
07		130	5 1/5
08		112	4 2/5
09		299	11 3/4
10		234	9 1/5
11		234	9 1/5
15		154	6
16		251	9 9/5
20		197	7 3/4
21		195	7 2/5
22		234	9 1/5
23		234	9 1/5
35		175	6 4/5
36		218	8 3/5
37		153	6
39		173	6 4/5
40		184	7 1/4



Code		mm.	inch.
01		202	8
02		202	8
03		231	9
04		176	6 8/9
05		176	6 8/9
06		204	8
07		138	5 2/5
08		106	4 1/6
09		330	13
10		235	9 1/4
11		235	9 1/4
15		150	5 8/9
16		251	9 8/9
20		202	8
21		202	8
22		235	9 1/4
23		235	9 1/4
25		185	7 1/4
36		210	8 1/4
37		185	7 1/4
39		182	7 1/6
40		185	7 1/4









mm 4,0
IMMAGINA



Code	mm.	inch.
01	203	8
02	203	8
03	210	8 1/4
04	177	7
05	177	7
06	190	7 1/2
07	133	5 1/4
08	113	4 2/5
09	308	12 1/4
10	237	9 1/3
11	237	9 1/3
15	157	6 1/6
16	248	9 3/4
18	241	9 1/2
20	203	8
21	203	8
22	237	9 1/3
23	237	9 1/3
24	134	5 1/4
35	177	7
37	177	7
39	177	7
40	187	7 1/3
45	177	7



ICE

Code		mm.	inch.
01		207	8 1/8
02		201	7 7/8
03		219	8 3/5
04		178	7
07		134	5 1/4
08		120	4 3/4
15		135	5 1/3
21		210	8 1/4

Arch. Katja Bremkamp

The asymmetrical and rather unfamiliar shape of this cutlery range was influenced by the way we handle certain situations relating to the table routine. I was looking at the movements of the hands when dishing food out of bowls, when serving onto a plate and how this movement alters when food is conveyed into the mouth. Each piece reflects these movements individually, referring to their purposes and their "actions", as some pieces are more asymmetrical than others. The overall asymmetrical shape of this range therefore supports the comfortable handling of cutlery and also acts as guide to the person who is using it.

La forma asimmetrica e non convenzionale di questo modello è stata influenzata dall'osservazione dei comportamenti e delle routine legate al consumo del cibo a tavola. Ho guardato i movimenti delle mani durante la disposizione del cibo sul piatto, la raccolta del boccone e l'accompagnamento alla bocca. Ogni pezzo riflette individualmente questi movimenti, riferendosi al loro scopo e alle loro azioni; questo spiega il motivo per cui alcuni pezzi sono più asimmetrici di altri. Oltretutto, l'asimmetria di questa linea avvantaggia la maneggevolezza della posata in modo da guidare la persona che la usa.



ICE

mm 3,0
KATJA



Code		mm.	inch.
01		208	8 1/5
02		208	8 1/5
03		235	9 1/4
04		180	7
05		180	7
06		210	8 1/4
07		133	5 1/4
08		115	4 1/2
09		315	12 2/5
10		248	9 3/4
11		245	9 2/5
12		235	9 1/4
13		210	8 1/4
15		156	6 1/7
16		242	9 1/2
18		250	9 5/6
19		250	9 5/6
20		210	8 1/4
21		210	8 1/4
22		248	9 3/4
23		248	9 3/4
24		134	5 1/4
25		205	8
26		156	6 1/7
35		180	7
36		235	9 1/4
37		170	6 2/5
39		180	7
40		185	7 1/4
44		175	6 8/9
45		180	7

Coltelli disponibili anche con manico vuoto
 Hollow handle knives available
 Couteaux disponibles aussi avec un manche creux
 Messer in Hohlheft-Ausführung erhältlich
 Cuchillo disponible también en mango hueco



Code		mm.	inch.
01		205	8
02		205	8
03		233	9 1/6
04		179	7
05		179	7
06		200	7 7/8
07		135	5 1/3
08		113	4 2/5
09		316	12 2/5
10		239	9 2/5
11		245	9 2/3
15		160	6 1/3
16		244	9 3/5
20		205	8
21		208	8 1/5
22		239	9 2/5
23		239	9 2/5
25		201	8
26		158	6 1/5
35		155	6 1/8
36		233	9 1/6
37		163	6 2/5
39		179	7
40		182	7 1/6
45		179	7



Maurizio Duranti

mm 3,5
LEVANTINA



Code	mm.	inch.
01	200	7 7/8
02	203	8
03	235	9 1/4
04	178	7
05	180	7
06	205	8
07	135	5 1/3
08	115	4 1/2
09	305	12
10	245	9 2/3
11	245	9 2/3
15	150	6
16	246	9 2/3
20	200	7 7/8
21	187	7 1/3
22	245	9 2/3
23	245	9 2/3
25	185	7 1/3
35	178	7
36	235	9 1/4
37	178	7
39	178	7
40	190	7 1/2

- ICE
- ORO ICE
- ORO NERO
- BRONZO
- CHAMPAGNE
- ARCOBALENO

Coltelli disponibili anche con manico vuoto
 Hollow handle knives available
 Couteaux disponibles aussi avec un manche creux
 Messer in Hohlheft-Ausführung erhältlich
 Cuchillo disponible también en mango hueco

Code	mm.	inch.
01	208	8 1/5
02	208	8 1/5
03	224	8 4/5
04	183	7 1/5
05	183	7 1/5
06	195	7 2/5
07	135	5 1/5
08	115	4 1/2
09	293	11 1/2
10	265	10 2/5
11	265	10 2/5
12	224	8 4/5
13	195	7 2/5
15	152	6
16	257	10 1/5
20	223	8 3/4
21	209	8 1/5
22	265	10 2/5
23	265	10 2/5
25	201	8
26	152	6
35	183	7 1/5
36	224	8 4/5
37	171	6 3/4
39	183	7 1/5
40	180	7



ICE



**Diciottesimo
 Premio Compasso d'Oro
 ADI**

Mediterranea
 Posate
Maurizio Duranti
 Designer
Mepra spa
 Produttore

Selezione d'onore
 Compasso d'Oro
 ADI 1998

Maurizio Duranti



01		209	8 1/5
02		209	8 1/5
03		235	9 1/4
04		180	7
05		180	7
06		204	8
07		136	5 1/3
08		114	4 1/2
09		315	12 2/3
10		250	9 5/6
11		250	9 5/6
12		235	9 1/4
13		204	8
15		155	6 1/3
16		243	9 1/2
17		236	9 1/3
18		253	10
19		251	9 5/6
20		210	8 1/4
21		207	8 1/7
22		250	9 5/6
23		250	9 5/6
24		140	5 1/2
25		195	7 2/3
26		155	6 1/3
35		190	7 1/2
36		224	8 4/5
37		170	6 2/3
39		180	7
40		184	7 1/4
44		165	6 1/2
45		208	8 1/5

Coltelli disponibili anche con manico vuoto
 Hollow handle knives available
 Couteaux disponibles aussi avec un manche creux
 Messer in Hohlheft-Ausführung erhältlich
 Cuchillo disponible también en mango hueco



Giulio Iacchetti

Code		mm.	inch.
01		201	8
02		201	8
03		219	8 2/5
04		180	7
05		180	7
06		195	7 2/5
07		140	5 1/2
08		113	4 2/5
09		320	12 3/5
10		245	9 2/5
11		245	9 2/5
15		153	6
16		256	10
20		213	8 2/5
21		206	8 1/5
22		245	9 2/5
23		245	9 2/5
25		201	8
35		180	7
36		219	8 2/5
37		195	7 2/5
39		180	7
40		190	7 1/2

mm 3,0
MORGANA



Code	mm.	inch.
01	200	7 7/8
02	204	8
03	230	9
04	180	7
05	180	7
06	204	8
07	135	5 1/3
08	113	4 2/5
09	310	12 1/5
10	240	9 1/2
11	245	9 2/3
15	150	5 8/9
16	252	10
20	222	8 3/4
21	203	8
22	240	9 1/2
23	240	9 1/2
25	201	8
35	180	7
36	230	9
37	204	8
39	180	7
40	180	7

I coltelli appoggiano sulla lama
 Knives may be set blade-down
 Les couteaux peuvent être posés debout sur leurs lames
 Durch das aussergewöhnliche Design, ist es möglich, die jeweiligen Messer auch hochkant, also "auf der Klinge stehend", abzustellen.
 Los cuchillos pueden apoyar sobre la hoja



Code		mm.	inch.
01		201	7 8/8
02		201	7 8/8
03		232	9 1/8
04		170	6 2/3
05		175	6 8/8
06		199	7 4/5
07		133	5 1/4
08		110	4 1/3
09		314	12 1/3
10		250	9 5/6
11		255	10
12		232	9 1/8
13		199	7 4/5
15		152	6
16		245	9 2/3
20		170	6 2/3
21		173	6 4/5
22		250	9 5/6
23		250	9 5/6
25		195	7 2/3
26		155	6 1/8
35		175	6 8/8
36		224	8 4/5
37		171	6 3/4
39		170	6 2/3
40		190	7 1/2
45		182	7 1/6

ICE

Coltelli disponibili anche con manico vuoto
 Hollow handle knives available
 Couteaux disponibles aussi avec un manche creux
 Messer in Hohlheft-Ausführung erhältlich
 Cuchillo disponible también en mango hueco

mm 4,0
NATURA



Coltelli disponibili anche con manico vuoto
 Hollow handle knives available
 Couteaux disponibles aussi avec un manche creux
 Messer in Hohlheft-Ausführung erhältlich
 Cuchillo disponible también en mango hueco

Code	mm.	inch.
01	205	8
02	205	8
03	230	9
04	175	6 7/8
05	175	6 7/8
06	203	8
07	133	5 1/4
08	112	4 1/2
09	310	12 1/2
10	254	10
11	255	10
12	230	9
13	203	8
15	152	6
16	243	9 3/5
17	239	9 3/5
18	254	10
19	252	10
20	206	8 1/5
21	206	8 1/5
22	254	10
23	254	10
24	135	5 1/3
25	195	7 3/5
26	160	6 1/3
27	160	6 1/3
28	180	7
35	175	6 7/8
36	233	9 1/6
37	171	6 3/4
39	175	6 7/8
40	188	7 3/5
44	165	6 1/2
45	175	6 7/8

mm 2,5
NORMA



Code	mm.	inch.
01	209	8 1/5
02	209	8 1/5
03	235	9 1/4
04	180	7
05	180	7
06	204	8
07	136	5 1/5
08	114	4 1/2
09	315	12 2/5
10	250	9 7/8
11	250	9 7/8
12	235	9 1/4
13	204	8
15	155	6
16	243	9 1/2
20	210	8 1/4
21	207	8 1/4
22	250	9 7/8
23	250	9 7/8
25	195	7 2/5
26	155	6 1/5
35	190	7 1/2
36	235	9 1/4
37	170	6 2/5
39	180	7
40	184	7 1/4
44	165	6 1/2
45	180	7

Coltelli disponibili anche con manico vuoto
 Hollow handle knives available
 Couteaux disponibles aussi avec un manche creux
 Messer in Hohlheft-Ausführung erhältlich
 Cuchillo disponible también en mango hueco



Code		mm.	inch.
01		205	8
02		205	8
03		236	9 1/2
04		180	7
05		180	7
06		200	7 7/8
07		135	5 1/2
08		115	4 1/2
09		320	12 3/4
10		250	9 7/8
11		250	9 7/8
12		236	9 1/2
13		200	7 7/8
15		155	6 1/2
16		242	9 1/2
17		236	9 1/2
20		180	7
21		180	7
22		250	9 7/8
23		250	9 7/8
25		195	7 2/3
26		155	6 1/2
35		180	7
36		224	8 4/5
37		170	6 2/3
39		180	7
40		185	7 1/4
44		165	6 1/2
45		208	8 1/5

Coltelli disponibili anche con manico vuoto
 Hollow handle knives available
 Couteaux disponibles aussi avec un manche creux
 Messer in Hohlheft-Ausführung erhältlich
 Cuchillo disponible también en mango hueco



Code	mm.	inch.
01	204	8
02	204	8
03	239	9 2/5
04	175	6 8/9
05	175	6 8/9
06	203	8
07	133	5 1/4
08	109	4 1/3
09	313	12 1/3
10	232	9 1/8
11	232	9 1/8
12	239	9 2/5
13	203	8
15	156	6 1/5
16	244	9 3/5
17	241	9 1/2
18	242	9 1/2
19	240	9 2/5
20	206	8 1/5
21	203	8
22	232	9 1/8
23	232	9 1/8
24	134	5 1/4
26	159	6 1/4
35	190	7 1/2
36	239	9 2/5
37	180	7
39	175	6 8/9
40	188	7 2/5
45	208	8 1/5

Coltelli disponibili anche con manico vuoto
 Hollow handle knives available
 Couteaux disponibles aussi avec un manche creux
 Messer in Hohlheft-Ausführung erhältlich
 Cuchillo disponible también en mango hueco

mm 3,0
SOLE



Code	mm.	inch.
01	208	8 1/5
02	208	8 1/5
03	234	9 1/5
04	185	7 1/4
05	183	7 1/5
06	208	8 1/5
07	138	5 2/5
08	109	4 1/3
09	317	12 1/2
10	240	9 1/2
11	245	9 2/3
15	157	6 1/5
16	240	9 1/2
20	182	7 1/6
21	175	6 8/9
22	240	9 1/2
23	240	9 1/2
40	175	6 8/9



Code	mm.	inch.
01	204	8
02	201	7 7/8
03	231	9
04	184	7 1/4
05	182	7 1/6
06	209	8 1/5
07	135	5 1/3
08	110	4 1/3
09	280	11
10	231	9
11	234	9 1/5
15	153	6
16	260	10 1/4
20	197	7 3/4
21	201	7 8/9
35	178	7
36	230	9
37	172	6 3/4

mm 3,0

STOCCOLMA

Giulio Iacchetti



Code		mm.	inch.
01		200	7 7/8
02		200	7 7/8
03		211	8 1/3
04		177	7
05		177	7
06		189	7 2/5
07		135	5 1/3
08		112	4 2/5
09		295	11 3/5
10		240	9 1/2
11		240	9 1/2
13		189	7 2/5
15		150	5 8/9
16		256	10
20		215	8 2/5
21		199	7 4/5
22		240	9 1/2
23		240	9 1/2
25		201	8
37		189	7 2/5
39		177	7
40		183	7 1/5

Coltelli disponibili anche con manico vuoto
Hollow handle knives available
Couteaux disponibles aussi avec un manche creux
Messer in Hohlheft-Ausführung erhältlich
Cuchillo disponible también en mango hueco

Code	mm.	inch.
01	206	8 1/8
02	206	8 1/8
12	238	9 2/5
04	179	7
05	179	7
13	212	8 1/3
07	132	5 1/5
08	110	4 1/3
09	306	12
10	250	9 5/6
11	250	9 5/6
15	155	6 1/8
16	240	9 2/5
20	212	8 1/3
21	207	8 1/7
22	250	9 5/6
23	250	9 5/6
35	180	7
36	236	9 1/3
37	190	7 1/2
39	179	7
40	185	7 1/4



Coltelli disponibili solo con manico vuoto
 Hollow handle knives only
 Couteaux disponibles seulement avec un manche creux
 Messer ausschliesslich in Hohlheft-Ausführung erhältlich
 Cuchillos disponibles solo con mango hueco

mm 3,5
VITTORIA



Maurizio Duranti

Questo modello e quello delle due pagine seguenti, sono disponibili nella versione ICE, ovvero con superficie satinata.

This model and that of the two following pages, are available in ICE version, that means with brushed finish surface.

Ce modèle et celui des deux pages après, sont disponibles dans la version ICE, qui signifie avec la surface de fin brossée.

Dieses Modell und die der folgenden zwei Seiten sind Ausführungen in der ICE Version. Sie verfügen über eine matte, gebürstete Oberfläche.

Este modelo y el de los dos páginas después, están disponibles en la versión ICE, que quiere decir con la superficie satinada



45 DUE ICE



41 ITALIA ICE



39 LEVANTINA ICE



47 LINEA ICE



57 GINEVRA ICE



42 NATURA ICE



40 MEDITERRANEA ICE



53 AVANGUARDIA ICE



Tutti i modelli delle pagine precedenti in versione acciaio inossidabile 18/10 lucido ed Ice, così come i modelli delle pagine seguenti in versione Titanio, sono completi di tutto ciò che serve in un ambiente a 5 stelle.

All of the flatware lines shown in the preceding pages in polished and brushed 18/10 gauge stainless steel, as well as those shown in the following pages in Titanium finishes, carry an extensive range of pieces, making them perfect for use in a 5-star setting.

Tous les modèles de la page précédente son dans la version acier inoxydable brillant et ICE, come les modèles des pages suivantes en Titane. Les series son complètes de toute l'ambiance d'un 5 étoiles.

Alle Besteckmodelle der vorhergehenden Seiten in poliertem und mattierte 18/10 Edelstahl verfügen, ebenso wie alle Modelle der nachfolgenden Seiten, die eine titanisierte Oberfläche aufweisen, über eine grosse Bandbreite von Einzel- bzw. Spezialteilen, ideal für die Verwendung in einem 5-Sterne Ambiente.

Todos los modelos de las paginas anteriores en versión acero inoxidable 18/10, así como los modelos de las paginas siguientes en versión Titanio, tienen la gama completa de todo necesario en un ambiente de 5 estrellas.



DESIGNPREIS
2009

NOMINEE

La speciale finitura non è ottenuta con metodi tradizionali come verniciatura o bagno galvanico, ma con un processo di impiantazione molecolare a base di titanio, frutto della ricerca aerospaziale.

Il prodotto è garantito per il lavaggio in lavastoviglie, non si macchia, non si ossida e resiste alla corrosione.

Unlike products that are coated or made with a galvanic process, our's is obtained using a titanium based molecular embedding process originally developed through aerospace research.

The product is dishwasher-safe, will not stain or oxidize and is highly resistant to corrosion.

Le produit n'est pas enduit ou fait avec un processus galvanique, Il est obtenu avec un processus à base de titane de d'implantation Moléculaire qui est le résultat de la recherche aérospatiale.

Le produit passe au lave-vaisselle, ne rouille pas ou ne s'oxyde pas et ne marque pas.

Die hier und vorher abgebildeten Bestecke, die mit einer Oberfläche aus Titan versehen sind, haben exakt die Farbe von Gold (ORO ICE), tiefem Schwarz (ORO NERO) und Bronze (BRONZO), was der Gestaltung von Tischen und Wohnräumen völlig neue Akzente verleiht. Das angewendete Veredelungsverfahren (P.V.D.) kommt aus der Raumfahrttechnik und war bisher bei der Gestaltung von Tabletop-Artikeln noch nie nicht angewendet worden bzw. völlig unbekannt.

Diese Produkte haben Dank des Titans eine 4 mal so harte Oberfläche wie Edelstahl, sehen nicht nur schön aus, sondern sind absolut robust und für den täglichen Gebrauch bestens geeignet.

Anfang des Jahres 2008 bekamen die Besteckmodell den begehrten Designpreis "Design Plus 2008" verliehen

El acabado especial no se obtiene de métodos tradicionales como barnizados o baño galvánico, se obtiene mediante un proceso de implantación molecular a base de titanio, fruto de la búsqueda aeroespacial.

El producto esta garantizado para el lavado en lava-vajillas, no se mancha, no se oxida y es resistente a la corrosión.

pag. 230

pag. 230



88 DUE ORO



89 LINEA ORO





92 DUE CHAMPAGNE



86 DUE ORO NERO



93 LINEA CHAMPAGNE



87 LINEA ORO NERO



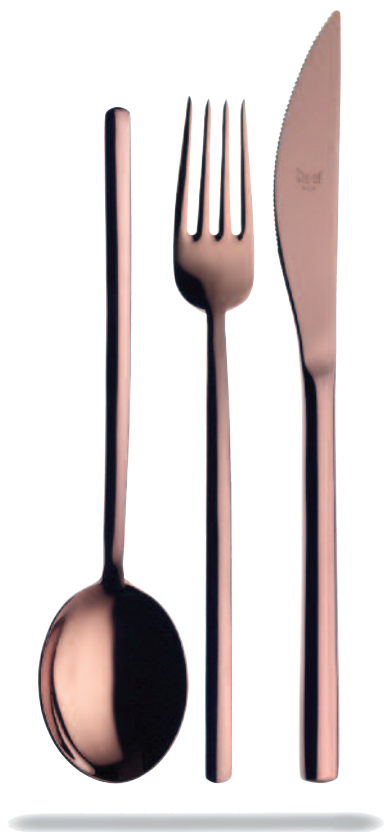

90 DUE BRONZO



80 DUE ICE ORO



91 LINEA BRONZO



81 LINEA ICE ORO





94 DUE ARCOBALENO



99 LINEA ARCOBALENO





01

Cucchiaino Tavola
Table spoon
Cuillère table
Tafellöffel
Cuchara de mesa

Cucchiaino per minestre e primi piatti
Spoon for soups and first courses

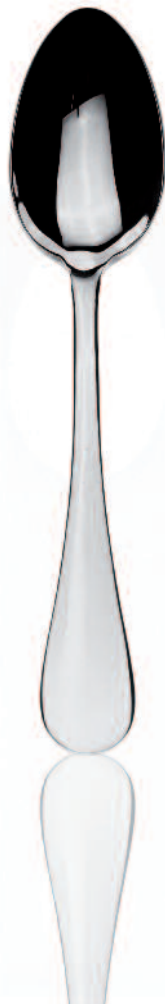

04

Cucchiaino Frutta
Dessert spoon
Cuillère à dessert
Dessertlöffel
Cuchara postre

Cucchiaino per dessert a base di crema e salse. Molto utile anche per la prima colazione
Spoon for cream or sweet sauce desserts, very helpful for breakfast to.



07

Cucchiaino Caffè
Tea spoon
Cuillère à café
Kaffeelöffel
Cuchara café

In realtà è un cucchiaino per tè e tisane, utilizzato anche per le zuccheriere e le formaggere. Dato i molteplici utilizzi, è sempre meglio possederne una mezza dozzina in più rispetto al resto della pezzeria. This is just a tea or herbal tea spoon, but is also used with sugar bowls and cheese basins. For this reason, it is better to have half of a dozen more than the rest of the cutlery.



08

Cucchiaino Moka
Coffee spoon
Cuillère à moka
Mokkalöffel
Cucharita moka

Cucchiaino per caffè
This is a coffee spoon

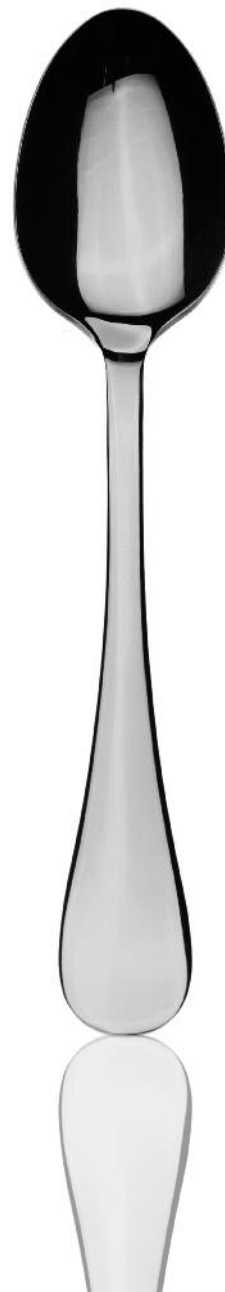

10

Cucchiaino a servire
Cooking spoon
Cuillère à legumes/ à ragût
Gemüselöffel
Cuchara legumbres

Si usa per servire sia primi piatti sia piatti principali. Buona regola possederne in quantità doppia rispetto al forchettone
It's used to serve first and main courses. It is better to have this cover twice than the cooking fork.



22

Cucchiaino Insalata
Salad serving spoon
Cuillère à salade servir
Salatvorlegelöffel
Cuchara servir ensalada

Si usa per mescolare e servire insalate, ma non solo: ottimo per servire antipasti a base di verdure e pesce. It is used to mix and serve salads, but is also very good to serve fish and vegetable hors-d'oeuvres.



23

Forchetta Insalata
Salad serving fork
Fourchette à salade servir
Salatvorlegegabel
Tenedor servir ensalada

Forchetta insalata
Si usa in coppia con
il cucchiaino insalata
Salad serving fork
It is used with the
salad spoon for serving.



25

Cucchiaino Bibita
Ice tea spoon
Cuillère à soda
Limonadenlöffel
Cucharita refresco

Cucchiaino per
cocktail e gelati
con creme in
coppe profonde
Spoon used for
cocktails and
ice-creams served
in deep drinking-
glasses.



44

Cucchiaino Cappuccino
Cappuccino spoon
Cuillère à cappuccino
Cappuccinolöffel
Cucharita cappuccino

Cucchiaino per
cocktail e gelati
con creme in
coppe profonde
Spoon used for
cocktails and ice-
creams served in
deep drinking-glasses.



39

Cucchiaino Gourmet
Gourmet spoon
Cuillère à dégustation
Kostprobelöffel
Cuchara degustación

Cucchiaino per dolci
e pesce con salse.
La parte schiacciata
della tazza, consente
sia di tagliare la
pietanza, che di
raccolgerne il sugo.
It's the spoon used
for cakes and fish
with sauce. The
crushed part of the
cup, allows both
to cut the course
and to collect the
juice.



45

Cucchiaino Degustazione
French sauce spoon
Cuillère à sauce individuelle
Gourmetlöffel
Cuchara salsa gourmet

Paletta per pesce
con salse, adatta a
tagliare il pezzo ed
a raccoglierne la
salsa.
Scoop for fish with
sauces, used to
cut the piece and
to reap the sauce.



35

Cucchiaino Zuppa
Soup spoon
Cuillère à soupe
Tassenlöffel rund
Cuchara para sopa

Cucchiaino per
consommé, tipica
forma di cucchiaino
per minestre in
brodo della tradizione
inglese.
It's the consommé
spoon used for the
traditionals English
soups.



26

Cucchiaino americano
American coffee spoon
Cuillère pour enfant
Kinderlöffel
Cucharita bebé

Cucchiaino per il
caffè americano. il
cappuccino, la
prima colazione,
oppure per dessert
a base di creme e
salse.
Spoon used for
american coffee,
cappuccino, breakfast
or for dessert with
cream and sauces.



02

Forchetta Tavola
Table fork
Fourchette table
Tafelgabel
Tenedor de mesa

Forchetta per primi piatti e piatto principale. Dato che è il pezzo in assoluto più utile ed usato, è sempre meglio possederne in doppia quantità rispetto agli altri pezzi.
Fork for first and main courses. It's better to have this cover twice, because it is the most useful one.



05

Forchetta Frutta
Dessert fork
Fourchette à dessert
Dessertgabel
Tenedor postre

Forchetta per antipasto e per dessert a base di frutta.
Utilizzata per sbaglio spesso anche per i dessert a base dolce.
Hors d'oeuvre fork used for fruit desserts, it is wrongly used for sweet desserts.



15

Forchettina Dolce
Cake fork
Fourchette à gateaux
Kuchengabel
Tenedor pastel

Forchetta per tutti i dolci e dessert, tranne quelli a base di frutta
Fork used only for cakes and sweet desserts, but not for fruit.



27

Forchettina Bebè
Baby fork
Fourchette pour enfant
Kindergabel
Tenedor bebè

Forchetta per bambini.
Fork for babies courses.



21

Forchetta Pesce da tavola
Table fish fork
Fourchette poisson table
Fischgabel
Tenedor pescado

Forchetta per pesce e molluschi
Fork for fishes and Mollusca



11

Forchettone a servire
Serving fork
Fourchette à légumes/ à servir
Fleischgabel
Tenedor legumbres

Si usa per servire sia primi piatti sia piatti principali.
It's used to serve first and main courses



03

Coltello Tavola
Table knife
Couteau table
Tafelmesser
Cuchillo de mesa

Coltello per piatto principale. Può essere in manico cavo, come le vecchie consigli in tavola in argento, leggero ed esclusivo; oppure in manico pieno prodotto con la tecnologia della forgiatura.

Table knife: Knife for main dishes with hollow handle, light and exclusive like the old fashioned silver covers or onepiece handle, made by the forging technology.



06

Coltello Frutta
Dessert knife
Couteau à dessert
Dessertmesser
Cuchillo postre

Coltello per antipasto e per dessert in combinazione con la forchetta frutta. Per qualità vale lo stesso discorso del coltello tavola

Used with the fruit fork in the hors-d'oeuvre and the fruit desserts. It's quality is the same of the table knife.



20

Paletta Pesce da tavola
Table fish knife
Couteau poisson table
Fischmesser
Cuchillo pescado

Coltello per tagliare pesce e molluschi
Knife used to slice fishes and Mollusca



28

Coltellino Bebè
Baby knife
Couteau pour enfant
Kindermesser
Cuchillo bebè

Coltellino per bambini.
Knife for babies courses.



36

Coltello Bistecca
Steak knife
Couteau à viande
Steakmesser
Cuchillo bistek

Coltello con lama profonda per bistecche di spessore.
Sharpedged blade knife helpful to cut substantial steaks



37

Coltello per burro
Butter knife
Couteau à beurre
Buttermesser
Cuchillo para mantequilla

Coltello per burro utilizzato per la prima colazione. Nella tradizione nordica ed inglese utilizzato sulla tavola accanto al posto tavola, per spalmare il burro sul pane in occasione di lunch e dinner.

Butter cover used during breakfast. In England and in the North European countries during lunch or dinner it is put in a dish near the table set to spread butter on the bread.

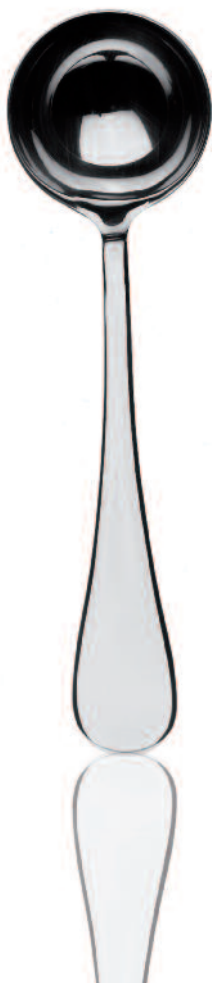

40

Mestolino per Salsa
Gravy ladle
Cuillère à sauce
Saucenöffel
Cacillo para salsaera

Si usa per servire
salse e condimenti
dalla salsiera
It is used to take sau-
ces and aromatic con-
diments from the
gravy boat.



16

Pala per Torta
Cake trowel
Pelle à tarte
Tortenheber
Pala tarta

Si usa per tagliare e
servire torte e semi-
freddi
It is used to portion
and serve cakes or
"semifreddi" (some
kinds of Italian icecre-
am).

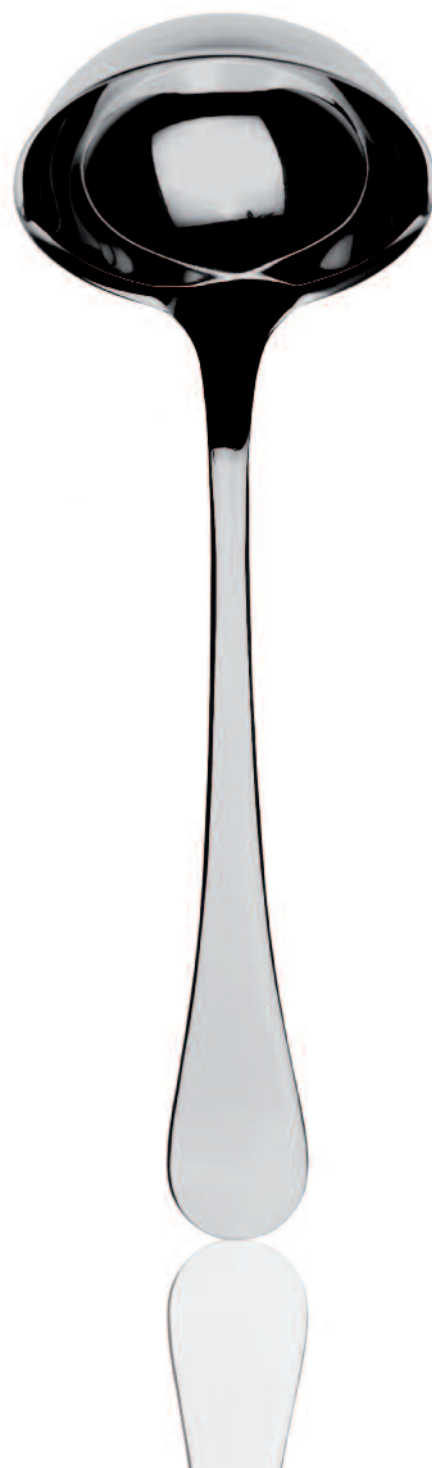

09

Mestolo a servire
Ladle
Louche
Suppenshöpfer
Cazo Sopa

Si usa per servire mine-
stre dalla zuppiera al piat-
to fondo
It's used to serve soups
from the tureen to the
(soup) plate.





QUARTA POSATA

Sono uno Chef, cerco di dare emozione con i gusti, sollecitando i ricordi e ispirando le persone. Ci sono Chef nel mondo che emozionano attraverso il gusto continuamente e lo fanno meglio di me. Uno di questi è Ferran Adrià, cui omaggio l'idea della Quarta Posata, ispirata dalla sua pinza per tapas, oggi cambiata e migliorata per usi nuovi a tavola, insieme ai JRE Italia.

Cucchiaio, Forchetta, Coltello, Quarta Posata. Da oggi possiamo divertirvi di più a tavola!

I'm a Chef, I try to create emotions through taste, soliciting the memories and inspiring people. There are Chefs in the world who continuously create emotions through taste and do it better than me. One of these chefs is Ferran Adrià, who I honor with the idea of the Quarta Posata, inspired by his tapas tongs, today changed and improved for new uses on table thanks to the collaboration with JRE Italy. Spoon, Fork, Knife, Quarta Posata. Starting today, we can have more fun on table!

Je suis un chef, je cherche à créer des émotions à travers le goût, la sollicitation souvenirs et inspirer les gens. Il y a des chefs dans le monde qui créent en permanence des émotions à travers le goût et le faire mieux que moi. L'un de ces chefs est Ferran Adrià, qui je honore avec l'idée de la Quarta Posata, inspiré par ses tapas pinces, a changé aujourd'hui et amélioré pour les nouvelles utilisations sur la table grâce à la collaboration avec JRE Italie.

Cuillère, Fourchette, Couteau, Quarta Posata. A partir d'aujourd'hui, nous pouvons avoir plus de plaisir sur la table!

JRE
JEUNES RESTAURATEURS

Ich bin ein Chef, ich versuche, Emotionen durch Geschmack zu schaffen, das Einholen Erinnerungen und inspirierenden Menschen. Es gibt Chefs in der Welt, die ständig Emotionen durch Geschmack schaffen und es besser ist als ich. Einer dieser Köche ist Ferran Adrià, die ich mit der Idee der Quarta Posata ehren, durch seine Tapas-Zange inspiriert, änderte sich heute und verbessert für neue Nutzungen auf dem Tisch dank der Zusammenarbeit mit JRE Italien.

Löffel, Gabel, Messer, Quarta Posata. Ab heute können wir mehr Spaß auf dem Tisch haben!

Soy un cocinero, trato de crear emociones a través del gusto, solicitando la recuerdos y gente inspiradora. Hay cocineros en el mundo que continuamente crear emociones a través del gusto y lo hacen mejor que yo. Uno de estos chefs es Ferran Adrià, que me honro con la idea de la Quarta Posata, inspirado por sus tapas pinzas, cambió hoy y mejorado para nuevos usos en la tabla gracias a la colaboración con JRE Italia. Cuchara, Tenedor, Cuchillo, Quarta Posata. A partir de hoy, podemos tener más diversión en la mesa!



Marco Stabile



QUARTA POSATA



10001129
Quarta posata

Lungh. cm. 22,2
Length 8 3/4"



CHOP STICKS

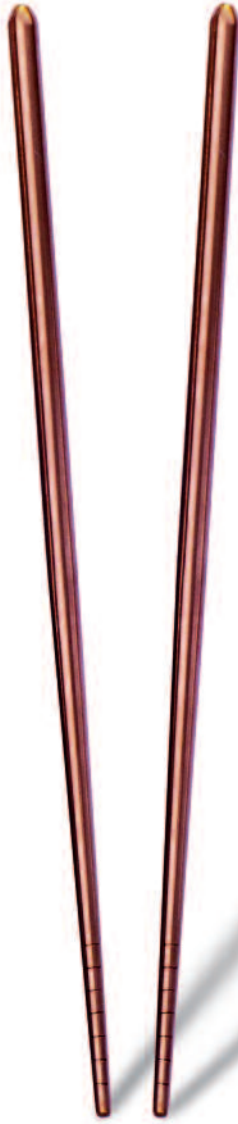

BRONZO
10001128B

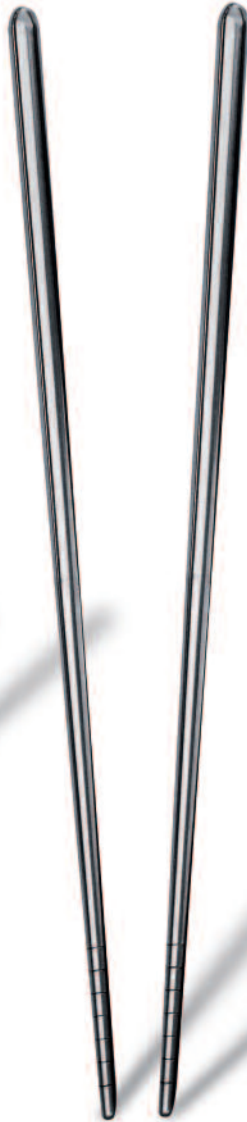

ACCIAIO
10001128



**ORO
NERO**
10001128N



ORO
10001128O

ORO ICE
10001128S



10001175
Appoggia chopstick
Chopstick rest
Porte chopstick
Ess-Stäbchen Ablage
Apoyo para chopstick

Largh. cm. 4,5
Width 1 3/4"

Paia Chopsticks
Chopsticks set 2 pcs.
Paire de chopsticks
Ess-Stäbchen Paar
Chopsticks 2 pzas.

cm. 22,5
8 7/8"



10001109



cm. 22
8 5/8"

mm. 3,0
Mestolo
Ladle
Louche
Suppschöpfer
Cazo sopa

10001142



cm. 20,7
8 1/8"

mm. 3,0
Cucchiaione
da risotto
Spoon for "Risotto"
Cuillère à "Risotti"
Reislöffel
Cuchara para arroz seco

10001110



cm. 17,5
6 3/4"

mm. 3,0
Cucchiaione
Serving spoon
Cuillère à servir
Servierlöffel
Cuchara servir

10001111



cm. 17
6 5/8"

mm. 3,0
Forchettone
Serving fork
Fourchette à servir
Serviergabel
Tenedor servir

10001122



cm. 17
6 5/8"

mm. 3,0
Cucchiaio insalata
Salad serving spoon
Cuillère à salade
Salatvorlegelöffel
Cuchara para ensalada

10001123



cm. 17
6 5/8"

mm. 3,0
Forchetta insalata
Salad serving fork
Fourchette à salade
Salatvorlegegabel
Tenedor para ensalada

10001116



cm. 18,5
7 1/4"

Pala per torta
Cake trowel
Pelle à tarte
Tortenheber
Pala tarta

10001115



cm. 10,5
4 1/4"

Forchettina dolce
Cake fork
Fourchette à gateaux
Kuchengabel
Tenedor pastel

10001120



cm. 15,5
6"

Paletta pesce tavola
Table fish knife
Couteau poisson
Fischmesser
Pala pescado

10001121



cm. 15,5
6"

Forchetta pesce tavola
Table fish fork
Fourchette poisson
Fischgabel
Tenedor pescado

10001141



cm. 12,5
4 7/8"

Happy spoon

10001127



cm. 10,5
4 1/4"

Cucchiaino bibita
Ice tea spoon
Cuillère à soda
Limonadenlöffel
Cucharita refresco

10001124



cm. 8,5
3 3/8"

Paletta gelato
Ice-cream spoon
Cuillère à glâce
Eislöffel
Cucharita helado



BISTECCA



UNI
10001136

Coltello bistecca
Steak knife
Couteau entrecôte
Steakmesser
Cuchillo bistek
cm. 21,3
8 1/4"

NORMA
10101136
BOHEME
10231136

Coltello bistecca
Steak knife
Couteau entrecôte
Steakmesser
Cuchillo bistek
cm. 23
9 1/8"

ROMA
10141136
NATURA
10341136
MICHELANGELO
10201136

Coltello bistecca
Steak knife
Couteau entrecôte
Steakmesser
Cuchillo bistek
cm. 22,7
8 7/8"

10001145

Forchetta bistecca
Steak fork
Fourchette à entrecôte
Tranchiergabel
Tenedor bistek
cm. 20,3
8"

NEW

10701136
CARINZIA

Coltello bistecca
Steak knife
Couteau entrecôte
Steakmesser
Cuchillo bistek
cm. 23,1
9 1/8"

NEW

10711136
STOCCOLMA

Coltello bistecca
Steak knife
Couteau entrecôte
Steakmesser
Cuchillo bistek
cm. 23,1
9 1/8"

BISTECCA



ACCIAIO

CON LOGO

ORO

ORO ICE

ORO NERO

BRONZO

10001144

10001144O

10001144OS

10001144N

10001144B

1144
 Coltello bistecca americano
 American steak knife
 Couteau entrecôte américain
 Amerikanisches Steakmesser
 Cuchillo bistek americano
 cm. 25
 9 5/8"

ARAGOSTE



10001140
Pinza aragosta
Lobster pincers
Pince à homard
Hummerzange
Pinzalangostas
cm. 18,5
7 1/3"



10001139
Forchetta aragosta
Lobster fork
Fourchette langouste
Hummergabel
Tenedor langostas
cm. 19,4
7 2/3"



10001143
Cucchiaio risotto
"Risotto" spoon
Cuillère "Risotto"
Reislöffel
Cuchara arroz seco
cm. 27,7
11"



10201143
MICHELANGELO
Cucchiaio risotto
"Risotto" spoon
Cuillère "Risotto"
Reislöffel
Cuchara arroz seco
cm. 27,7
11"



10001137
Coltellino
Little knife
Petit couteaux
Kleine Messer
Cuchillo pequeño
cm. 18
7 1/16"



10201144
Cucchiaino cappuccino
Cappuccino spoon
Cuillère cappuccino
Cappuccinoiöffel
Cucharita cappuccino
cm. 16,5
6 1/2"



10001150
Golf club mixer spoon
Golf club mixer spoon
Golf crosse pour cocktail
Golf Schleger für Long drink
Golf club cucharita por coctél
cm. 16,5
6 1/2"

Modelli-Models
POSATE

LUMACHE



200779
Molla lumache
Escargot tongs
Pince escargots
Schneckenzange
Pinzas caracoles
cm. 15,6
6 1/4"



10001138
Forchetta lumache
Escargot fork
Fourchette escargots
Schnecken-gabel
Tenedor caracoles
cm. 14,9
5 7/8"



10521131
Mini Forchetta
Appetizer fork
Fourchette amouse bouche
Minigabel
Mini tenedor
cm. 11,4
4 1/2"



10521108
Mini spoon
cm. 11,4
4 1/2"



10001175
Appoggia posate
Knife rest
Soutier p/couverts
Besteck Ablage
Apoyo p/cubiertos
Largh. cm. 6,5
Width 2 1/2"



10001147
Forchetta formaggio
Cheese fork
Fourchette fromage
Käsegabel
Tenedor queso
cm. 21
8 3/8"



10001125
Coltello formaggio
Cheese knife
Couteau fromage
Kaesemesser
Cuchillo queso
cm. 22
8 3/4"



10001126
Coltello parmigiano
Parmesan chesse knife
Couteau parmesan
Parmesanmesser
Cuchillo parmigiano
cm. 16,5
6 1/2"

FORMAGGIO

Vasellame



HOLLOWARE
MATERIEL DE SERVICE
ACCESSOIRES
ORFEBRERIA

- Gamma completa per tutti gli usi
- Spessore elevato
- Doppia saldatura manici, alta resistenza
- Beccucci rompigoccia
- Prodotti impilabili salvaspazio
- Criterio di progettazione di ogni prodotto accuratamente studiato per il quotidiano uso nel settore alberghiero.
- Each collection offers an extensive range of different items.
- Thicker stainless steel.
- Double welded handles offer durability.
- Drip-less spouts on all pitchers, creamers, coffee and tea pots.
- Space saving stackable items.
- Hospitality grade and professional quality

MEPRA
S.p.A.

- Gamme complète pour tous les us
- Épaisseur massives
- Soudures manches haute résistance
- Becs rompigoutes
- Articles empilables pour sauver space
- Critère de projet de chaque produit est étudié pour l'usage quotidien soigneusement dans le secteur hôtelier

- Ein vollständiges Sortiment für jeden Gebrauch
- Hohe Materialstärke
- Doppelt geschweisste
- Handgriffe, hohe Widerstandsfähigkeit
- Kein Tropfen beim Ausgießen
- Stapelbar und platzsparend
- Jedes Produkt ist genaustens für den täglichen
- Gebrauch in der Spitzengastronomie und -hotellerie gestaltet

- Gamma completa para todos los usos.
- Espesor macizo
- Mango soldado de alta resistencia.
- Vertedor rompe gotas
- Producto apilable ahorra espacio
- Criterio de diseño de cada producto estudiado minuciosamente para el uso cotidiano en el sector hostelero.

MEPRA
S.p.A.





964



mm. 1,2	Vassoio rettangolare con maniglie	cm. 40x27	15 ³ / ₄ " x 10 ⁵ / ₈ "
	Rectangular Tray with handles	cm. 45x31	17 ³ / ₄ " x 12 ¹ / ₄ "
	Plateau rectangulaire avec anses	cm. 50x34	19 ⁵ / ₈ " x 13 ³ / ₈ "
	Tablett rechteckig mit Griffen	cm. 60x42	23 ⁵ / ₈ " x 16 ¹ / ₈ "
	Bandeja rectangular con asas		

963GN



mm. 1,2	Vassoio rettangolare gastronomico	cm. 53 x 32,5	20 ³ / ₄ " x 12 ² / ₃ "
	Rectangular gastronomic Tray		
	Plateau rectangulaire gastronomico		
	Tablett rechteckig gastronomico		
	Bandeja rectangular gastronomico		

963



mm. 1,2	Vassoio rettangolare	cm. 30x21	11 ³ / ₄ " x 8 ¹ / ₄ "
	Rectangular Tray	cm. 35x24	13 ³ / ₄ " x 9 ¹ / ₂ "
	Plateau rectangulaire	cm. 40x27	15 ³ / ₄ " x 10 ⁵ / ₈ "
	Tablett rechteckig	cm. 45x31	17 ³ / ₄ " x 12 ¹ / ₄ "
		cm. 50x34	19 ⁵ / ₈ " x 13 ³ / ₈ "
		cm. 60x42	23 ⁵ / ₈ " x 16 ¹ / ₈ "
	Bandeja rectangular		

966



mm. 1,2	Vassoio tondo	Ø cm. 13	Ø 5 1/8"
	Round Tray	Ø cm. 19	Ø 7 1/2"
	Plateau rond	Ø cm. 24	Ø 9 1/2"
	Tablett rund	Ø cm. 27	Ø 10 5/8"
		Ø cm. 35	Ø 13 3/4"
		Ø cm. 40	Ø 15 3/4"
	Bandeja redonda		

965



mm. 1,2	Vassoio rettangolare con piedini	cm. 30x21	11 ³ / ₄ " x 8 ¹ / ₄ "
	Rectangular Tray with feet	cm. 35x24	13 ³ / ₄ " x 9 ¹ / ₂ "
	Plateau rectangulaire avec socles	cm. 40x27	15 ³ / ₄ " x 10 ⁵ / ₈ "
	Tablett rechteckig mit Füßen	cm. 45x31	17 ³ / ₄ " x 12 ¹ / ₄ "
		cm. 50x34	19 ⁵ / ₈ " x 13 ³ / ₈ "
		cm. 60x42	23 ⁵ / ₈ " x 16 ¹ / ₈ "
	Bandeja rectangular con 4 pies		

967



mm. 1,2	Vassoio tondo con piedini	Ø cm. 27	Ø 10 5/8"
	Round Tray with feet	Ø cm. 35	Ø 13 3/4"
	Plateau rond avec socles	Ø cm. 40	Ø 15 3/4"
	Tablett rund mit Füßen		
	Bandeja redonda con 4 pies		

950



mm. 1,2	Ciotola con base	Ø cm. 14	cl. 60	Ø 5 1/2"	oz. 20 1/4
	Bowl with base	H cm. 8,8		H 3 1/2"	
	Bol avec socle	Ø cm. 20	lt. 1,8	Ø 7 7/8"	oz. 60 7/8
	Obstschale auf Fuss	H cm. 11		H 4 1/2"	
	Cuenco con pedestal	Ø cm. 24	lt. 3,1	Ø 9 1/2"	oz. 104 7/8
		H cm. 14		H 5 1/2"	
	Ø cm. 28	lt. 5,1	Ø 11"	gal. 1 1/4	
	H cm 16		H 6 1/3"		

977



mm. 1,2	Porta pasticcini	Ø cm 13	Ø 5 1/8"
	Petit-fours stand	H cm 10,5	H 4 1/8"
	Porte-petit fours		
	Petits Fours-Ständer	Ø cm 19	Ø 7 1/2"
	Porta dulces	H cm 14	H 5 1/2"

981/A



mm. 1,2	Alzata portafrutta rettang. 2 piani	cm 35x24	13 3/4" x 9 1/2"
	Rectangular fruit holder 2 layers	cm 45x31	17 3/4" x 12 1/4"
	Serviteur rectangulaire 2 etages	H cm 50	H 19 5/8"
	Etagere, rechteckig 2-stufig		
	Frutero rectangular 2 pisos		

981/B



mm. 1,2	Alzata portafrutta rettang. 3 piani	cm 35x24	13 3/4" x 9 1/2"
	Rectangular fruit holder 3 layers	cm 45x31	17 3/4" x 12 1/4"
	Serviteur rectangulaire 3 etages	cm 60x42	25 5/8" x 16 1/8"
	Etagere, rechteckig 3-stufig	H cm 73	H 28 3/4"
	Frutero rectangular 3 pisos		

978



mm. 1,2	Porta pasticcini a 2 piani	Ø cm. 13	Ø 5 1/8"
	Petit-fours stand 2 layers	Ø cm. 19	Ø 7 1/2"
	Porte-petit fours 2 etages	H cm. 29	H 11 3/8"
	Mokkaétagère 2 Ebenen		
	Porta dulces 2 pisos		

97803



mm. 1,2	Porta pasticcini a 3 piani	Ø cm 13	Ø 5 1/8"
	Petit-fours stand 3 layers	Ø cm 19	Ø 7 1/2"
	Porte-petit fours 3 etages	Ø cm 27	Ø 10 3/8"
	Mokkaétagère 3 Ebenen	H cm 36	H 14 1/4"
	Porta dulces 3 pisos		

980/B



mm. 1,2	Alzata portafrutta tonda 3 piani	Ø cm 27	Ø 10 5/8"
	Round fruit holder 3 layers	Ø cm 35	Ø 13 3/4"
	Serviteur rond 3 etages	Ø cm 40	Ø 15 3/4"
	Etagere, rund 3-stufig	H cm 73	H 28 3/4"
	Frutero redondo 3 pisos		

980/A



mm. 1,2	Alzata portafrutta tonda 2 piani	Ø cm 27	Ø 10 5/8"
	Round fruit holder 2 layers	Ø cm 35	Ø 13 3/4"
	Serviteur rond 2 etages	H cm 50	H 19 5/8"
	Etagere, rund 2-stufig		
	Frutero redondo 2 pisos		

959



960

Coppa in vetro con piedistallo
Glass bowl with base
Coupe ronde en verre a/socle
Glassobstschale rund auf Fuß
Cuenco redondo en vidrio con pedestal

Ø cm 21,5	Ø 8 1/2"
H cm 29	oz. 91 3/8
cl. 270	H 11 3/8"
Ø cm 12	Ø 4 3/4"
H cm 17	H 6 3/4"
cl. 45	oz. 15 1/4

958



Coppa multiservizio
Glass bowl with sauce cap
Coupe multifonctions
Universalschale
Ensaladera multiservicio

Ø cm 28	Ø 11"
H cm. 14	H 5 1/2"
cl. 300	oz. 101 1/2

961



Piatto quadro in vetro con piedistallo
Square glass plate with base
Plateau carré en verre a/socle
Obstchale, quadratisch, auf Fuss
Plato cuadrado en vidrio con pedestal

cm. 24,5x24,5	9 5/8" x 9 5/8"
H cm 17	H 6 3/4"

962



Piatto da torta in vetro con piedistallo
Glass cake plate with base
Plat pour gateau en verre a/socle
Kuchenplatte aus Glas auf Fuss
Plato para tarta en vidrio con pedestal

Ø cm 33	Ø 12 3/4"
H cm 16	H 6 1/4"

938



mm. 1,2 Vassoio ovale
Oval tray
Plateau oval
Tablett oval
Bandeja oval

cm. 31 x 22	12 1/8" x 8 3/4"
-------------	------------------

937



mm. 1,2 Cestino per pane
Oval basket
Corbeille oval
Brotkorb oval
Frutero oval

cm. 31 x 22	12 1/8" x 8 3/4"
lt. 1,7	oz. 57 1/2

968



mm. 2,0	Ampolla e formaggera	cl. 22	cl. 20
	Cruet and cheese basin	H cm 15	
	Huillière et fromagère	oz. 7 1/2	oz. 6 3/4
	Essig-Ölflasche und Käsedose	H 5 7/8"	
	Vinagrera y quesera		

969



mm. 2,0	Salino e porta stuzzicadenti	cl. 8	cl. 7
	Salt-cellar and toothpick container	H cm. 9	H cm 7
	Salière et porte cure-dents	oz. 2 3/4	oz. 2 3/8
	Salzstreuer und Zahnstocherbehälter	H 3 1/2"	H 2 3/4"
	Salero y palillero		

971

975



mm. 1,2	Chillcup	cl. 15	oz. 5 1/8
	Caviar dish	H cm 19	H 7 1/2"
	Bol à caviar		
	Chillcup / Kaviarschale		
	Bol para caviar		

976



mm. 1,2	Servizio per antipasto	Ø cm. 20	Ø 7 7/8"
	Snack server	H cm 15	H 5 7/8"
	Support à snacks	cl. 15 (x3)	oz. 5 1/8 (x3)
	Relish-Pickles-Gestell		
	Entremesera		

935



mm. 1,2	Porta macaron	Ø cm 15	Ø 5 7/8"
	Macarons server	H cm 10	H 4"
	Porte macarons		
	Macaronsträger		
	Porta macaron		

976S



mm. 1,2	Portasalatini impilabile	Ø cm. 20	Ø 7 7/8"
	Stackable snack server	cl. 15 (x3)	oz. 5 1/8 (x3)
	Support à snack empilable		
	Stapelbare Relish-Pickles-Gestell		
	Servicio por entremes impilable		
	976C	Ø cm. 20	Ø 7 7/8"
		H cm 15	H 5 7/8"
		cl. 15 (x3)	oz. 5 1/8 (x3)

951



mm. 1,2	Caffettiera con piedistallo Coffee pot with base Cafetière avec socle Kaffekanne auf Fuss Cafetera con pedestal	Tazze	4	cl 34	oz 12 ¹ / ₃
		Cups Bols Tassen Tazas	6	cl 52	oz 17 ² / ₃

952



mm. 1,2	Teiera con piedistallo Tea pot with base Théière avec socle Teekanne auf Fuss Tetera con pedestal	Tazze	2	cl 37	oz 13
		Cups Bols Tassen Tazas	6	cl 60	oz 21

953



mm. 1,2	Lattiera con piedistallo Milk jug with base Pot à lait avec socle Milchkanne auf Fuss Jarra lechera con pedestal	Tazze	2	cl 24	oz 8
		Cups Bols Tassen Tazas	4	cl 34	oz 12 ¹ / ₃

954



mm. 1,2	Zuccheriera con piedistallo Sugar bowl with base Sucrier avec socle Zuckerdose auf Fuss Azucarero con pedestal	Tazze	6	cl 27	oz 10
		Cups Bols Tassen Tazas			

957



mm. 1,2	Portabustine da zucchero Sugar packet holder Pot à sucre Zuckerstangengefäß Azucarera	Ø cm	7	Ø 2 3/4"
		H cm	9,5	H 3 3/4"

982



mm. 1,2	Alzata portafrutta Fruit holder Serviteur Obstschale Frutero	Ø cm	27	Ø 10 5/8"
		H cm.	15	H 5 7/8"

247

247



mm. 0,8
Cloche con pomolo
Cloche with knob
Cloche
Teller cloche
Tapa con pomo

Ø cm. 10,5	Ø 4 1/16"
Ø cm. 13	Ø 5 1/16"
Ø cm. 20	Ø 7 7/8"
Ø cm. 22	Ø 8 5/8"
Ø cm. 24	Ø 9 1/2"
Ø cm. 26	Ø 10 1/4"
Ø cm. 28	Ø 11"
Ø cm. 31	Ø 12 1/8"
Ø cm. 32	Ø 12 5/8"

984



984
Ø cm 22
H.cm.45
985
Ø cm 18
H.cm.33
989
Ø cm 30
H.cm.52

984
Ø 8¹³/₁₆"
H 17¹/₄"
985
Ø 7 1/8"
H 13"
989
Ø 11 3/4"
H 20¹/₂"

98402
Ø cm 22
H cm.35
Ø 8¹³/₁₆"
H 13 3/4"

Alzata portapiatti
Afternoon tea stand
Présentoir à gateau
Dessert-Serviergestell
Soporte platos

mm. 1,2
Presentoire
2 misure
2 sizes
2 tailles
2 Größen
2 tamaños

974

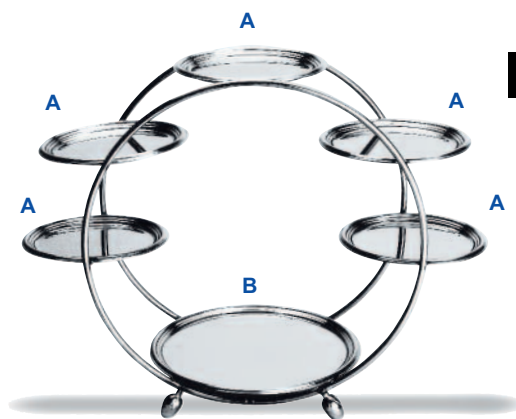

A Ø cm.13 (x5)	A Ø 5 1/8" (x5)
B Ø cm.19	B Ø 7 1/2"
A Ø cm.19 (x5)	A Ø 7 1/2" (x5)
B Ø cm.27	B Ø 10 5/8"

7092



7092

Candelabro a 1 fiamma
Candlestick
Chandelier
Leuchter 1-flammig
Candelabro

Silverplated
H cm. 28,5
H 11 1/4"



7093

Candelabro a 3 fiamme
Candelabra, 3 arms
Chandelier 3 flammes
Leuchter 3-flammig
Candelabro 3 luces

Silverplated
H cm. 34,5
H 13 5/8"



7094

Candelabro a 5 fiamme
Candelabra, 5 arms
Chandelier 5 flammes
Leuchter 5-flammig
Candelabro 5 luces

Silverplated
H cm. 34,5
H 13 5/8"

7094

972



972

mm. 1,2
972-972P
 Secchiello per ghiaccio
 Ice bucket
 Seau à glaçons
 Eisgefäß
 Cubitera hielo

Ø cm 15
 H cm 18
 cl.150

Ø 5 7/8"
 H 7 1/8"
 oz. 50 3/4



973



973P

mm. 1,2
973-973P
 Secchiello per spumante
 Sparkling wine cooler
 Seau à champagne
 Wein- und Sektkühler
 Cubo para champany

Ø cm 20,5
 H cm 24,5
 cl.500

Ø 8 1/8"
 H 9 5/8"
 gal. 1 1/3



972P

666F

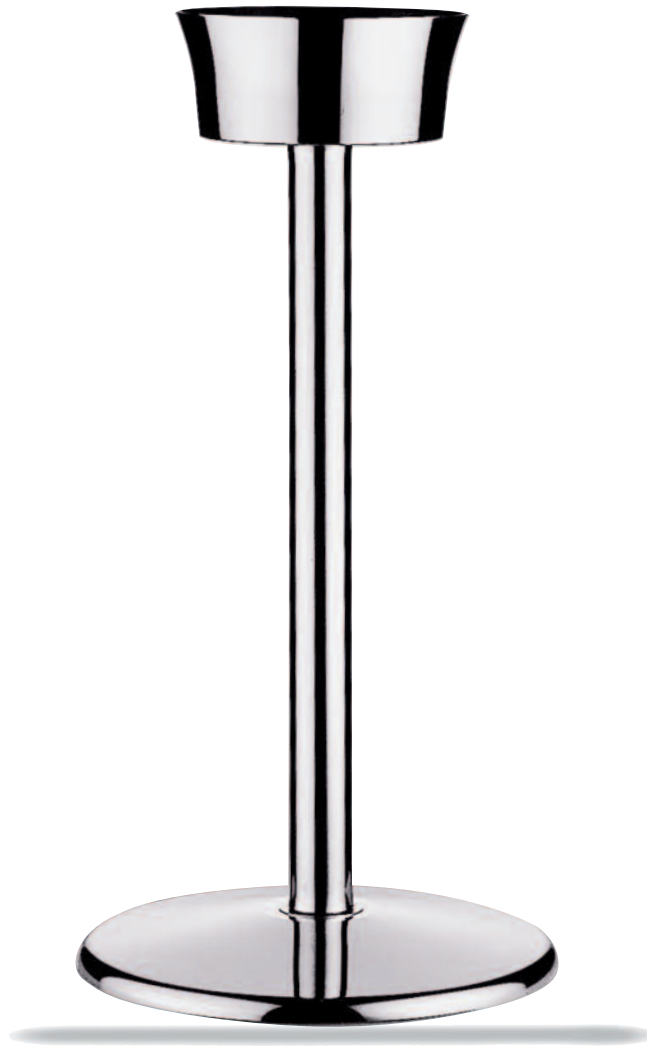

mm. 1,2
 Colonna portasecchiello spumante
 Wine cooler stand w/weighted base
 Pied pour seau à champagne
 Weinkühlerständer
 Columna porta cubo champany

H cm. 67,5 | H 26 5/8"

657



mm. 0,8 Coppa per champagne con inserto
Champagne bowl with insert
Vasque a champagne avec anneau porte-verre
Champagner Bowl mit Gläser - Flaschenring
Copa para champagne con anillo

Ø cm. 38	Ø 15"
H cm. 29,5	H 11 5/8"
lt. 15	gal. 4

949



mm. 1,2 Supporto per informazioni o menu
Menu / Card holder
Porte nom numéro de table
Karten-Speisekartenhalter
Porta informaciones o menu

Ø cm. 10	Ø 4"
H cm. 10	H 4"

986



mm. 0,8 Alzata per crudité rettangolare
Rectangular seafood presentation
Serviteur à poisson crude rectang.
Etagere, rech., für marinierte Fisch
Porta pescado rectangular

cm. 53 x 32,5	20 3/4" x 12 2/3"
H cm. 9	H 3 1/2"
lt. 9,0	gal. 2

995



mm. 2,0 Portanumero
Table number stand
Numbers etched to order
Porte numéro de table
Tischnummernständer
Porta numero de mesa

A	A
Ø cm 13	Ø 5 1/8"
H cm 54	H 21 1/4"
B	B
Ø cm 13	Ø 5 1/8"
H cm 30	H 11 7/8"

987



mm. 0,8 Alzata per crudité rettangolare
Elevated rectangular seafood presentation
Serviteur à poisson crude rectang.
Etagere, rech., für marinierte Fisch
Porta pescado rectangular

cm. 53 x 32,5	20 3/4" x 12 2/3"
H cm. 25,8	H 10 1/7"
lt. 9,0	gal. 2

253



mm. 0,8 Rinfrescatore con piedini
Yogurt cooler with feet
Rafrachisseur à yaourts a/socles
Yoghurtkühler mit Füßen
Refrigerador para yogurt con pies

Ø cm 35	Ø 13 3/4"
H cm. 12	H 4 3/4"
lt. 2,0	oz. 67 3/5

983

944



mm. 1,2	Zuppiera	Ø cm. 14 - lt. 0,6	Ø 5 1/2" - oz. 20 1/4
	Soup tureen	Ø cm. 18 - lt. 1,2	Ø 7" - oz. 40 5/8
	Soupière	Ø cm. 20 - lt. 1,8	Ø 7 7/8" - oz. 60 7/8
	Suppenterrine	Ø cm. 22 - lt. 2,5	Ø 8 5/8" - oz. 84 1/2
	Sopera	Ø cm. 24 - lt. 3,1	Ø 9 1/2" - oz. 104 7/8
		Ø cm. 26 - lt. 3,9	Ø 10 1/4" - oz. 131 7/8
		Ø cm. 28 - lt. 5,1	Ø 11" - gal. 1 1/4

945



mm. 1,2	Legumiera	Ø cm. 14 - lt. 0,6	Ø 5 1/2" - oz. 20 1/4
	Vegetable dish	Ø cm. 18 - lt. 1,2	Ø 7" - oz. 40 5/8
	Lègumiere	Ø cm. 20 - lt. 1,8	Ø 7 7/8" - oz. 60 7/8
	Lègumier	Ø cm. 22 - lt. 2,5	Ø 8 5/8" - oz. 84 1/2
	Legumbrera	Ø cm. 24 - lt. 3,1	Ø 9 1/2" - oz. 104 7/8
		Ø cm. 26 - lt. 3,9	Ø 10 1/4" - oz. 131 7/8
		Ø cm. 28 - lt. 5,1	Ø 11" - gal. 1 1/4

946



mm. 1,2	Coperchio per art. 944 - 945	Ø cm. 14	Ø 5 1/2"
	Lid for art. 944 - 945	Ø cm. 18	Ø 7"
	Couvercle pour art. 944 - 945	Ø cm. 20	Ø 7 7/8"
	Deckel für art. 944 - 945	Ø cm. 22	Ø 8 5/8"
	Tapa para art. 944 - 945	Ø cm. 24	Ø 9 1/2"
		Ø cm. 26	Ø 10 1/4"
		Ø cm. 28	Ø 11"

936



Cloche trasparente con pomolo	Ø cm 28	Ø 11"
Transparent cloche with knob		
Cloche transparente		
Transparente Teller cloche		
Tapa transparente		

940



939

mm. 1,2	Servizio per caffè macchiato	H cm 18	H 7 1/8"
	Café au lait set	cl. 102	oz. 34
	Service pour café au lait		
	Café au lait-Set		
Juego café au lait			

940/5



mm. 1,2	Servizio per caffè macchiato	H cm 18	H 7 1/8"
	5pcs Sugar, milk and coffee set	cl. 15 (x5)	oz. 5 1/8 (x5)
	Service sucre, lait et café 5 pièces		
	Milch-Kaffee-Zucker Set 5-Tlg.		
Juego leche, café y azucar 5 piezas			

943



mm. 1,2 | Spargisale, portastecchi
Salt & Pepper
Sel-poivre/porte cure-dents
Salz-Pfeffer-Zahnstocherbehälter
Saleros y pimentero y palillero

H cm. 15 | H 5 7/8"
cl. 7,5 (x 2) | oz. 2 1/2 (x 2)

988



mm 1,2 | Portamarmellata a 3 scomparti
Jam pack holder 3 compartment
Porte-confiture 3 comp.
Marmeladgestell 3 Einsätze
Marmeladero 3 comp.

H. cm. 15 | H 5 7/8"
cl. 28 (x3) | oz. 9 1/2 (x3)

942



mm. 1,2 | Oliera
Cruet
2 pièces huile-vinaigre
Essig-/Ölgestell
Vinagreras

H cm. 22 | H 8 5/8"
cl. 22,5 (x 2) | oz. 7 1/2 (x 2)

947

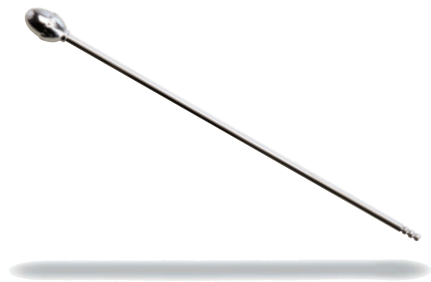

Versatore per profumo a goccia
Perfume drops dispenser
Verseur de parfum en gouttes
Tropf-Parfüm Aussteller
Versador de perfume en gotas

Lungh. cm 18,5 | Length 7 5/8"

940/3



940/4

mm. 1,2 | Servizio per zucchero 3 e 4 pezzi
Sugar set 3 and 4 pcs.
Service pour sucre 3 et 4 pièces
Sahne-/Zucker-Set 3- und 4-Tlg
Juego azucar 3 y 4 piezas

H cm. 15 | H 5 7/8"
cl. 15 (x3) | oz. 5 1/8 (x3)
cl. 15 (x4) | oz. 5 1/8 (x4)

NEW

922



mm. 1,2 | Mini burriera con coperchio
Small butter dish w/lid
Petit beurrier a/couvercle
Mini Butterdose m/Deckel
Platillo para mantequilla
con tapa

cm. 12 x 6 | 4 3/4" x 2 1/3"
cl. 15 | oz. 5 1/8



257



mm. 1,2	Porta pasticcini con piedistallo	Ø cm. 14	Ø 5 1/2"
	Petit-fours stand with base	H cm. 8,7	H 3 1/2"
	Porte-petits-fours avec socle	Ø cm. 20	Ø 7 7/8"
	Petits Fours-Ständer	H cm. 13	H 5 1/8"
Porta dulces con pedestal	Ø cm. 28	Ø 11"	
		H cm. 14,5	H 5 3/4"

258



mm. 1,2	Porta pasticcini con piedistallo	Ø cm. 14	Ø 5 1/2"
	Petit-fours stand with legs	Ø cm. 20	Ø 7 7/8"
	Porte-petits-fours avec socle	Ø cm. 28	Ø 11"
	Mokkaétagère 3 Ebenen	H cm. 27	H 10 5/8"
Porta dulces con pedestal			

220



NEW

mm. 1,2	Coppa per punch	Ø cm. 38	Ø 15"
	Punch bowl	H cm. 32,3	H 11 5/8"
	Bol à punch	lt. 15	gal. 4
	Punch Bowl		
Ponchera			

255

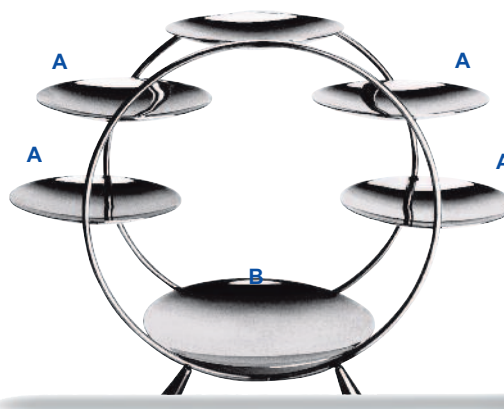

mm. 1,2	Presentoire	25514	25514
	3 misure	A Ø cm.14 (x5)	A Ø 5 1/2" (x5)
	3 sizes	B Ø cm.20	B Ø 7 7/8" (x5)
	3 tailles	25520	25520
3 Größen	A Ø cm.20 (x5)	A Ø 7 7/8" (x5)	
3 tamaños	B Ø cm.24	B Ø 9 1/2" (x5)	
	25524	25524	
	A Ø cm.24 (x5)	A Ø 9 1/2" (x5)	
	B Ø cm.28	B Ø 11"	

7060



7060

7071

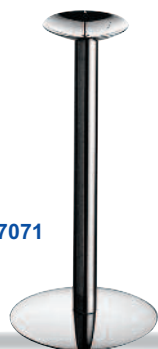

7072



7073



7073

Candelabro bugia	H cm. 13	Candelabro a 1 fiamma	H cm. 23,6	Candelabro a 3 fiamme	H cm. 23,6	Candelabro a 5 fiamme	H cm. 23,6
Candlestick	H 5 1/8"	Candlestick	H 9 1/4"	Candelabra, 3 arms	H 9 1/4"	Candelabra, 5 arms	H 9 1/4"
Chandelier		Chandelier		Chandelier 3 flammes		Chandelier 5 flammes	
Leuchter mit Kerze		Leuchter 1-flammig		Leuchter 3-flammig		Leuchter 5-flammig	
Candelabro		Candelabro		Candelabro 3 luces		Candelabro 5 luces	

141



mm. 1,2	Vassoio NOVECENTO	cm. 30 x 21	11 3/4" x 8 1/4"
	Tray »	cm. 35 x 24	13 3/4" x 9 1/2"
	Plateau »	cm. 40 x 27	15 3/4" x 10 5/8"
	Tablett »	cm. 45 x 31	17 3/4" x 12 1/4"
	Bandeja »	cm. 50 x 34	19 5/8" x 13 3/8"
		cm. 60 x 42	23 5/8" x 16 1/2"
		cm. 80 x 54	31 1/2" x 21 1/4"

144



mm. 1,2	Vassoio con maniglie NOVECENTO	cm. 40 x 27	15 3/4" x 10 5/8"
	Tray with handles »	cm. 45 x 31	17 3/4" x 12 1/4"
	Plateau avec anses »	cm. 50 x 34	19 5/8" x 13 3/8"
	Tablett mit Griffen »	cm. 60 x 42	23 5/8" x 16 1/2"
	Bandeja con asas »	cm. 65 x 53	25 5/8" x 20 7/8"
		cm. 80 x 54	31 1/2" x 21 1/4"

141GN



mm. 1,2	Gastronorm NOVECENTO	1/1	1/1
	"	cm. 53 x 32,5	20 7/8" x 12 2/3"
	"		
	"		
	"	2/1	2/1
		cm. 65 x 53	25 5/8" x 20 7/8"

144GN



mm. 1,2	Gastronorm con maniglie NOVECENTO	1/1	1/1
	Gastronorm with handles »	cm. 53 x 32,5	20 7/8" x 12 2/3"
	Gastronorm avec anses »		
	Gastronorm mit Griffen »		
	Gastronorm con asas »	2/1	2/1
		cm. 65 x 53	25 5/8" x 20 7/8"

146GN



mm. 1,2	Gastronorm NOVECENTO	1/1	1/1
	"	cm. 53 x 32,5	20 7/8" x 12 2/3"
	"		
	"		
	"	2/1	2/1
		cm. 65 x 53	25 5/8" x 20 7/8"

146



mm. 1,2	Vassoio con maniglia sovrapponibile	cm. 30 x 21	11 3/4" x 8 1/4"
	Tray with stackable handles	cm. 35 x 24	13 3/4" x 9 1/2"
	Plateau avec anses empilables	cm. 40 x 27	15 3/4" x 10 5/8"
	Tablett mit stapelbaren Griffen	cm. 45 x 31	17 3/4" x 12 1/4"
	Bandeja con asas empilables	cm. 50 x 34	19 5/8" x 13 3/8"
		cm. 60 x 42	23 5/8" x 16 1/2"
		cm. 80 x 54	31 1/2" x 21 1/4"

137



mm. 1,2	Vassoio quadro NOVECENTO	cm. 60 x 60	23 5/8" x 23 5/8"
	Square tray »		
	Plateau carré »		
	Tablett, quadratisch »		
	Bandeja cuadrada »		

256



mm. 1,2	Vassoio rotondo	GIOTTO	Ø cm. 27	Ø 10 5/8"
	Round tray	»	Ø cm. 35	Ø 13 3/4"
	Plateau rond	»	Ø cm. 40	Ø 15 3/4"
	Tablett rund	»		
	Bandeja redonda	»		

138



mm. 1,2	Vassoio quadro con maniglie NOVECENTO	cm. 60 x 60	23 5/8" x 23 5/8"
	Sqaer tray with handles »		
	Plateau carré avec anses »		
	Tablett, quadratisch mit Griffen »		
	Bandeja cuadrada con asas »		

AIRLINES

140



mm. 1,2	Vassoio per compagnie aeree	ATLAS	cm. 38,5 x 21
	Airlines tray for on board service		15 1/8" x 8 1/4"
	Ideal for aircraft and corporates jets		
	Chariot de service	KSSU	cm. 40,4 x 27,9
	Bordservice -Tablett f. Airlines		15 7/8" x 11"
	Bandeja de servicio para comp. aéreas		

139



mm. 1,2	Vassoio quadr.c/man.sovrappon.	cm. 60 x 60	23 5/8" x 23 5/8"
	Square tray w/stackable handles		
	Plateau carré a/anses empliabes		
	Tablett quadr.m/stapelb. Griffen		
	Bandeja cuadrada c/asas empil.		

250

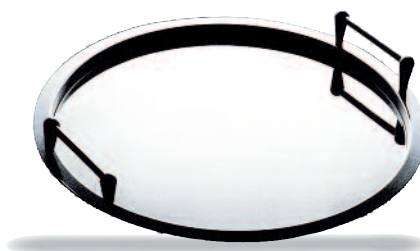

mm. 1,2	Vassoio con maniglia sovrapponibile	Ø cm. 35	Ø 13 3/4"
	Tray with stackable handles	Ø cm. 40	Ø 15 3/4"
	Plateau avec anses empliabes		
	Tablett mit stapelbaren Griffen		
	Bandeja con asas empilables		

295



mm. 1,2	Vassoio tondo con piedistallo	Ø cm. 35	Ø 13 3/4"
	Round tray with base	H cm. 12,5	H 4 7/8"
	Plateau rond avec socle		
	Obstschale, rund auf Fuß		
	Bandeja redonda con pedestal		

297



mm. 1,2	Vassoio ovale con piedistallo	cm. 45 x 30	17 3/4" x 11 3/4"
	Oval tray with base	H cm. 12,5	H 4 7/8"
	Plateau oval avec socle		
	Obstschale, oval auf Fuß		
	Bandeja oval con pedestal		

296



mm. 1,2	Vassoio rettang. con piedistallo	cm. 45 x 30	17 3/4" x 11 3/4"
	Rectangular tray with base	H cm. 12,5	H 4 7/8"
	Plateau rectang. avec socle		
	Tablett, rechteckig auf Fuß		
	Bandeja rectang. con pedestal		

298



mm. 1,2	Piatto torta con piedistallo	Ø cm. 40	Ø 15 3/4"
	Cakes plate with base	H cm. 9,5	H 3 3/4"
	Plat à tarte avec socle		
	Kuchenplatte auf Fuß		
	Bandeja tarta con pedestal		

287



mm. 2,0	Vassoio rettangolare per buffet	cm. 30x21	11 3/4" x 8 1/4"
	Rectangular Tray for buffet	cm. 40x27	15 3/4" x 10 5/8"
	Plateau rectangulaire pour buffet	cm. 50x34	19 5/8" x 13 3/8"
	Buffet -Tablett, rechteckig	cm. 60x42	23 5/8" x 16 1/8"
	Bandeja rectangular para entremes		

288



mm. 2,0	Vassoio tondo per buffet	Ø cm. 30	Ø 11 3/4"
	Round Tray for buffet	Ø cm. 40	Ø 15 3/4"
	Plateau rond pour buffet	Ø cm. 50	Ø 19 5/8"
	Buffet-Tablett rund	Ø cm. 60	Ø 23 5/8"
	Bandeja redondapara entremes		

7004A



mm. 0,8	Alzata per pesce crudo	Ø cm. 34	Ø 13 3/4"
	Marinated fish holder	Ø cm. 41	Ø 16 1/8"
	Serviteur à poisson crude	H cm. 55	H 21 5/8"
	Etagere für marinierten Fisch		
Porta pescado			

7004B



mm. 1,2	Alzata per pesce crudo	Ø cm. 22	Ø 8 5/8"
	Marinated fish holder	Ø cm. 34	Ø 13 3/8"
	Serviteur à poisson crude	H cm. 38	H 15"
	Etagere für marinierten Fisch		
Porta pescado			

7002/B



mm. 1,2	Alzata portafrutta	NOVECENTO	cm. 35x24	13 3/4" x 9 1/2"
	Fruit holder	»	cm. 45x31	17 3/4" x 12 1/4"
	Serviteur	»	cm. 60x42	23 5/8" x 16 1/2"
	Etagere	»	H cm. 70	H 27 5/8"
	Frutero	»		

7001/B



mm. 1,2	Alzata portafrutta	GIOTTO	Ø cm. 27	Ø 10 5/8"
	Fruit holder	»	Ø cm. 35	Ø 13 3/4"
	Serviteur	»	Ø cm. 40	Ø 15 3/4"
	Etagere	»	H cm. 70	H 27 5/8"
	Frutero	»		

67301



67304

mm. 1,2

Portagiaccio termico con coperchio
Insulated ice-bucket with lid
Seau à glaçons thermique
avec couvercle
Isolier-Eisgefäß, mit Deckel
Cubitera hielo térmica con tapa

Ø cm 14
H cm 13,5
lt. 0,70

Ø cm 24
H cm 23
lt. 2,75

Ø 5 1/2"
H 5 1/9"
oz. 23 2/3

Ø 9 1/2"
H 9"
oz. 93

mm. 1,2



668

Secchiello per spumante
Sparkling wine cooler
Seau à champagne
Wein- und Sektkühler
Cubo para champany

Ø cm 24
H cm 23
lt. 2,75

Ø cm 14
H cm 13,5
lt. 0,70

Ø 9 1/2"
H 9"
oz. 93

Ø 5 2/3"
H 5 1/9"
oz. 23 2/3

666E



mm. 1,2

Colonna portasecchiello spumante
Wine cooler stand
Pied pour seau à champagne
Weinkühlerständer
Columna porta cubo champany

H cm. 67,5

H 26 5/8"

686



mm. 1,2	Champagnera 5 bott. c/pied.	Ø cm. 40	Ø 15 3/4"
	Giant Champagne bucket 5 bot.	H cm. 38,5	H 15 1/6"
	Seau à champagne p/5 bout.	lt. 15	gal. 4
	Champagner Bowl 5 Fläsche		
	Cubo de champagne p/5 bot.		

685



mm. 1,2	Champagnera 5 bott. s/pied.	Ø cm. 40	Ø 15 3/4"
	Giant Champagne bucket 5 bot.	H cm. 21,8	H 8 3/5"
	Seau à champagne p/5 bout.	lt. 15	gal. 4
	Champagner Bowl 5 Fläsche		
	Cubo de champagne p/5 bot.		

666I



mm. 1,2	Colonna portabottiglie spumante	H cm. 78	H 30 5/7"
	Wine cooler stand		
	Pied pour seau à champagne		
	Weinkühlerständer		
	Columna porta cubo champany		

265

N E W



mm. 1,2	Vassoio per pasticceria	cm. 24,5 x 17	9 5/8" x 6 3/4"
	Pâtisserie tray	cm. 30 x 21	11 3/4" x 8 1/4"
	Plateau pour pâtisserie	cm. 34 x 24	13 3/8" x 9 1/2"
	Pâtisserie Tablett		
	Bandeja para pastelería		

516

516

51610



mm. 1,2	Portabustine da zucchero	516	516
	Sugar packet holder	cm. 10 x 7	4" x 2 3/4"
	Pot à sucre	H cm. 3	H 1 1/8"
	Zuckerstangengefäß		
	Azucarera	51610	51610
		cm. 10 x 5	4" x 2"
		H cm. 4,5	H 1 3/4"

206

N E W

205

518

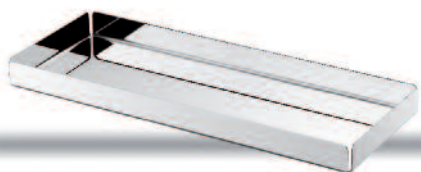

Vassoio per pasticceria	cm. 26 x 12
	cm. 60 x 12
Pâtisserie tray	10 1/4" x 4 3/4"
Plateau pour pâtisserie	23 3/5" x 10 1/5"
Pâtisserie Tablett	
Bandeja para pastelería	
mm. 1,2	



Cesto portapane, porta agrumi	cm. 33 x 26
Basket for bread/ for fruit	H cm. 20
Panier / Porte agrumes	13" x 10 1/5"
Brot-/Früchtekorb	H 7 7/8"
Cesto por pan/ por cítricos	
mm. 1,2	



con piedistallo	cm. 26 x 12
with foot	cm. 60 x 12
avec socle	H cm. 13
mit Fuss	10 1/4" x 4 3/4"
con pies	23 3/5" x 10 1/5"
	H 5 1/8"

704

N E W

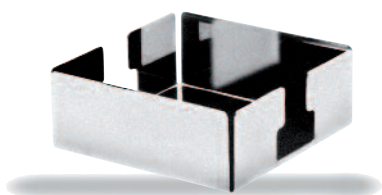

mm. 1,2	Portatovaglioli	cm. 13 x 13	5 1/9" x 5 1/9"
	Napkin holder		
	Distributeur de serviettes		
	Serviettenhalter		
	Portaservilletas		

N E W

270



mm. 1,2	Portatovaglioli	cm. 12,5 x 4,5	5" x 1 7/8"
	Napkin holder		
	Distributeur de serviettes	H cm. 7	H 2 3/4"
	Serviettenhalter		
	Portaservilletas		

143



mm. 1,2 Vassoio
Tray
Plateau
Tablett
Bandeja

cm. 30,5 x 25,5 12" x 10"

259



mm. 1,2 Ciotola con base
Bowl with base
Bol avec socle
Obstschale auf Fuss
Cuenco con pedestal

Ø cm. 20
H cm. 14,3
lt. 2,1

Ø 5 2/3"
H 7 7/8"
gal. 1/2

Ø cm. 28
H cm. 18,3
lt. 5,7

Ø 11"
H 7 1/5"
gal. 1 1/2

864



GALA
Cestino semitraforato
Half fretworked basket
Corbeille demi-ajouré
Schale, halbgelocht
Frutero semiperforado

Ø cm. 22
H cm. 5,7
cl. 150

Ø 8 5/8"
H 2 1/4"
oz. 50 3/4

mm. 0,8

834



GALA
Cestino portafrutta
Round basket
Corbeille ronde
Schale, rund
Frutero redondo

Ø cm. 22
H cm. 5,7
cl. 150

Ø cm. 34
H cm. 5,7
cl. 500

Ø 8 5/8"
H 2 1/4"
oz. 50 3/4

Ø 13 3/8"
H 2 1/4"
gal. 1 1/3

mm. 0,8

863



GALA
Cestino traforato
Fretworked basket
Corbeille ajouré
Schale, gelocht
Frutero perforado

Ø cm. 22
H cm. 5,7
cl. 150

Ø 8 5/8"
H 2 1/4"
oz. 50 3/4

mm. 0,8

254



Supporto per informazioni o menu
Menu / Card holder
Porte nom numéro de table
Karten / Speisekartenhalter
Porta informaciones o menu

Ø cm. 6
H cm. 9

Ø 2 1/2"
H 3 1/2"

mm. 0,8



907

Portamenù
Menù holder
Porte-menu
Menükartenhalter
Portamenu

cm. 21 x 13,5
H cm 29,7

8 5/8" x 5 3/8"
H 11 3/4"

mm. 0,8

53



994

Portanumero
Table number stand
Numbers etched to order
Porte numéro de table
Tischnummernständer
Porta numero de mesa

mm. 0,8

A
Ø cm 8,3
H cm 47,3

B
Ø cm 8,3
H cm 24

A
Ø 3 1/4"
H 18 5/8"

B
Ø 3 1/4"
H 9 1/2"

712



mm. 1,2 | Chillcup per burro e caviale con base
Chillcup for butter and caviar with base
Chillcup pour beurre et caviar avec socle
Chillcup für Butter und Kaviar mit Fuß
Chillcup para mantequilla y caviar con pedestal

713



Chillcup per burro
Chillcup for butter
Chillcup pour beurre
Chillcup für Butter
Chillcup para mantequilla

Ø cm. 12
cl. 150
Ø 4 3/4"
oz. 50 3/4



Servizio per caviale
Caviar set
Service à caviar complet
Kaviarschale
Servicio para caviar

Ø cm. 18
cl. 150
Ø 7 1/8"
oz. 50 3/4

301



301A

301C

301B

mm. 0,8 | Chillcup per cocktail di gamberetti
Supreme bowl, complete
Coupe à crevettes
Chillcup für Hummercocktail
Chillcup para coctél mariscos

301 Ø cm. 15
cl. 17,5
301A Ø cm. 15
301B Ø cm. 13,5
301C Ø cm. 9,5
cl. 17,5

Ø 5 7/8"
oz. 6
301A Ø 5 7/8"
301B Ø 5 3/8"
301C Ø 3 3/4"
oz. 6

725

722



mm. 0,6 | Piatino per coppa gelato
Under liner for ice-cream bowl
Petit plat soucoupe glace
Unterteller für Eisschale
Platillo melado

Ø cm. 12
Ø 4 3/4"

Coppa per gelato e macedonia
Ice-cream and salad fruit bowl with stand
Coupe à glace et macédoine
Eisfrüchteschale
Copa helado y macedonia

Ø cm. 8,5
cl. 15
Ø 3 3/4"
oz. 5 1/8

723



mm. 1,2 | Coppa per gelato
Ice-cream bowl
Coupe à glace
Eisschale
Copa helado

Ø cm. 9,5
cl. 17

Ø 3 3/4"
oz. 6

498



mm. 1,2	Completo oliera con spargisale a 5	H cm. 22	H 8 5/8"
	Cruet and salt cellar set 5 pcs.	cl. 22,5 (x 2)	oz. 7 1/2 (x 2)
	Service huile-vinaigre 5 pcs.	cl. 7,5 (x 3)	oz. 2 1/2 (x 3)
	Essig-/Ölgestell 5-Tlg.		
	Convoy vinagreras con saleros 5 pzs		

507



mm. 1,2	Completo oliera con spargisale a 4	H cm. 22	H 8 5/8"
	Cruet and salt cellar set 4 pcs.	cl. 22,5 (x 2)	oz. 7 1/2 (x 2)
	Service huile-vinaigre 4 pcs.	cl. 7,5 (x 2)	oz. 2 1/2 (x 2)
	Essig-/Ölgestell 4-Tlg.		
	Convoy vinagreras con saleros 4 pzs		

506



430502

mm. 1,2	Oliera	GALA	H cm. 22	H 8 5/8"
	Cruet	»	cl. 22,5 (x 2)	oz. 7 1/2 (x 2)
	2 pièces huile-vinaigre	»		
	Essig-/Ölgestell	»		
	Vinagreras	»		

525



mm. 1,2	Formaggera	GALA	cl. 20	oz. 6 3/4
	Parmesan cheese basin	»		
	Fromagère	»		
	Käsedose	»		
	Quesera-Azucarero	»		

513



430502SS

mm. 1,2	Spargisale, portastecchi	GALA	H cm. 15	
	Salt-cellar with toothpick container	»	cl. 7,5 (x 3)	
	Selz-/Pfeffer-Zahnstocherbehälter	»		H 5 7/8"
	Saleros y pimentero y palillero	»		oz. 2 1/2 (x 3)

NEW

702



mm. 1,2	Mini burriera con coperchio	cm. 12 x 6	4 3/4" x 2 1/3"
	Small butter dish w/lid	cl. 15	oz. 5 1/8
	Petit beurrier a/couvercle		
	Mini Butterdose m/Deckel		
	Platillo para mantequilla con tapa		

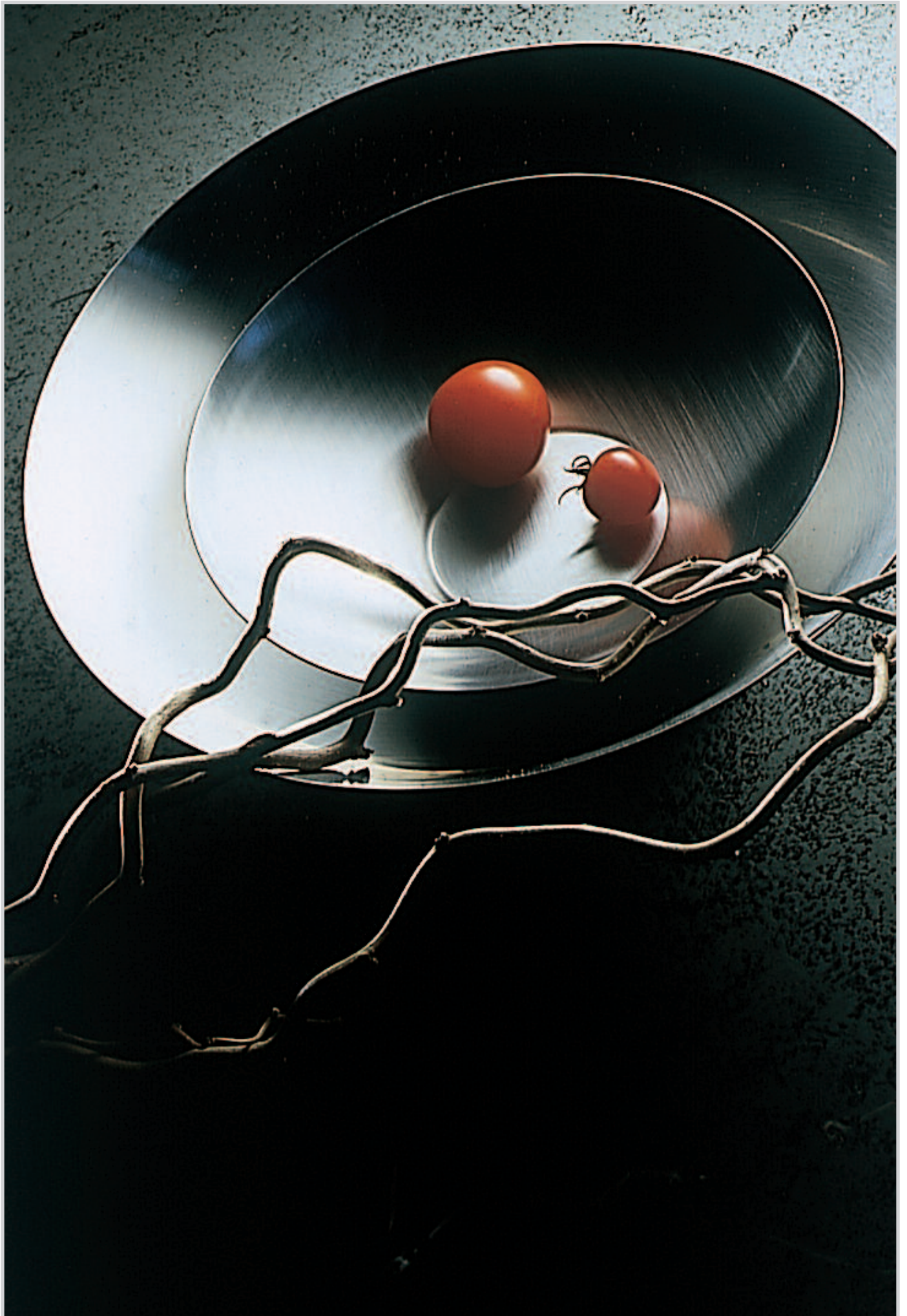

609



mm. 1,2	Piano Tray Plateau Tablett oval Bandeja	cm. 40 x 36	15 3/4" x 14 1/8"
---------	---	-------------	-------------------

612



mm. 1,2	Piano forato Tray fretworked handles Plateau avec anses ajourée Grifftablett oval Bandeja asa perforada	cm. 40 x 36	15 3/4" x 14 1/8"
---------	---	-------------	-------------------

613



mm. 1,2	Fondo Bowl Bol Brotschale oval Cuenco	cm. 22 x 20 cl. 80	8 5/8" x 7 7/8" oz. 27
		cm. 40 x 36 lt. 4,0	15 3/4" x 14 1/8" gal. 1

614



mm. 1,2	Fondo forato Bowl fretworked handles Bol avec anses ajourée Griffschale oval Cuenco asa perforada	cm. 22 x 20 cl. 49	8 5/8" x 7 7/8" oz. 16 1/2
		cm. 40 x 36 lt. 2,6	15 3/4" x 14 1/8" oz. 87 7/8

617



mm. 1,2	Sottopiatto ovale Charger oval Assiette de bienvenue ovale Platzteller oval Bajo plato oval	cm. 34 x 31 cm. 39 x 36	13 3/8" x 12 1/4" 15 3/8" x 14 1/8"
---------	---	----------------------------	--

616AC



mm. 1,2	Piattino per pane Bread tray Plat pour pan Brot Platte Plato para pan	cm. 14 x 12	5 1/2" x 4 3/4"
---------	---	-------------	-----------------

561



mm. 1,2	Rettangolare piano	cm. 23 x 13	9" x 5 ¹ / ₈ "
	Rectangular tray	cm. 38 x 25	15" x 9 ⁷ / ₈ "
	Plateau rectangulaire		
	Tablett, rechteckig		
	Bandeja rectangular		

562



mm. 1,2	Rettangolare fondo	cm. 38 x 25	15" x 9 ⁷ / ₈ "
	Rectangular bowl	H cm. 5,1	H 2"
	Bol rectangulaire	cl. 300	oz. 101 ¹ / ₂
	Obstschale, rechteckig		
	Cuenco rectangular		

557



mm. 1,2	Ovale piano	cm. 37 x 25	14 ¹ / ₂ " x 9 ⁷ / ₈ "
	Oval tray	cm. 46 x 31	18 ¹ / ₈ " x 12 ¹ / ₄ "
	Plateau, oval		
	Tablett, oval		
	Bandeja oval		

558



mm. 1,2	Ovale fondo	cm. 37 x 25	14 ¹ / ₂ " x 9 ⁷ / ₈ "
	Oval bowl	H cm. 6,3	H 2 ¹ / ₂ "
	Bol oval	cl. 250	oz 84 ¹ / ₂
	Obstschale, oval		
	Cuenco oval	cm. 46 x 31	18 ¹ / ₈ " x 12 ¹ / ₄ "
		H cm. 6,3	H 2 ¹ / ₂ "
		cl. 400	gal. 1

563



mm. 1,2	Quadro piano	cm. 15 x 15	5 ⁷ / ₈ " x 5 ⁷ / ₈ "
	Square tray	cm. 22 x 22	8 ⁵ / ₈ " x 8 ⁵ / ₈ "
	Plateau carré		
	Tablett, quadratisch		
	Bandeja cuadrada		

564

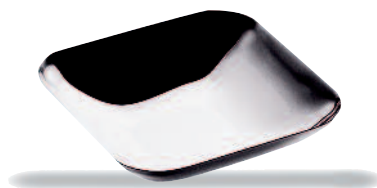

mm. 1,2	Quadro fondo	cm. 15 x 15	5 ⁷ / ₈ " x 5 ⁷ / ₈ "
	Square bowl	H cm. 4,9	H 2"
	Bol carré	cl. 50	oz. 16 ⁷ / ₈
	Schale, quadratisch		
	Cuenco cuadrado	cm. 22 x 22	8 ⁵ / ₈ " x 8 ⁵ / ₈ "
		H cm. 4,9	H 2"
		cl. 150	oz. 50 ³ / ₄

559



mm. 1,2	Tondo piano Wine bottle coaster Plateau ronde Tablett rund Bandeja redonda	Ø cm. 12	Ø 4 3/4 "
---------	--	----------	-----------

560



mm. 1,2	Tondo fondo Round bowl Bol ronde Obstschale, rund Cuenco redondo	Ø cm. 12 H cm. 3,9 Ø cm. 15 H cm. 5 Ø cm. 22 H cm. 5,8 Ø cm. 32 H cm. 6,8	cl. 26 cl. 60 cl. 131 lt. 3,0	Ø 4 3/4" oz. 8 3/4 H 1 1/2" Ø 5 7/8" oz. 20 1/4 H 2" Ø 8 5/8" oz. 44 1/3 H 2 1/4" Ø 12 5/8" oz. 101 2/5 H 2 2/3"
---------	--	--	--	---

568

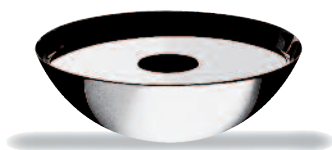

mm. 1,2	Posacenere ad acqua Water ashtray Cendrier à eau Wasserascher rund Cenicero ad agua	Ø cm. 12 cl. 26	Ø 4 3/4 " oz 8 4/5
---------	---	--------------------	-----------------------

569



mm. 1,2	Posacenere ad acqua Water ashtray Cendrier à eau Wasserascher quadrat. Cenicero ad agua	cm. 15 x 15 cl. 50	5 7/8" x 5 7/8" oz 16 7/8
---------	---	-----------------------	------------------------------

567



mm. 1,2	Sottopiatto Charger Assiette de bienvenue Platzteller Bajo plato	cm. 32 x 32	12 5/8" x 12 5/8"
---------	--	-------------	-------------------

N E W

870

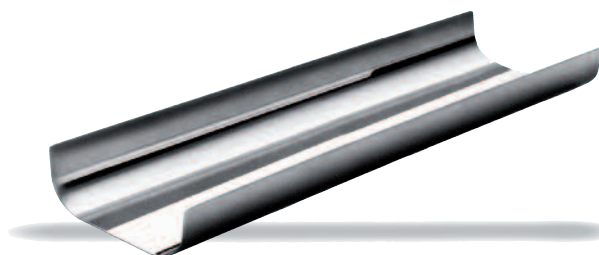

mm. 1,2	GIOTTO Portapane / Portagrissini Bread / Bread sticks holder Porte pan / Porte gressin Brot und-Grissini -Schale Portapan / Porta bastoncillos de pan	cm. 35,5 x 11	14" x 4 1/3"
---------	--	---------------	--------------

596

599



608

mm. 1,2 | Cestini traforati
Fretworked baskets
Corbeilles, ajourées
Früchtekorb gelocht
Cestas perforadas

596
Ø cm. 16,8
H cm. 11
cl. 150

Ø 6 5/8"
H 4 3/8"
oz. 50 3/4

608
Ø cm. 27
H cm. 13,5
lt. 5

Ø 10 1/2"
H 5 1/4"
gal. 1 1/3

599
Ø cm. 29
H cm. 18,5
lt. 8

Ø 11 3/8"
H 7 1/4"
gal. 2

730



mm. 1,2 | Spumantiera 12 bottiglie champagne
Giant champagne bucket for 12 bottles
Seau à champagne géante pour 12 bouteilles
Champagner Bowl für 12 Flaschen
Cubo de champagne gigante para 12 botellas

cm. 75 x 65
H cm. 19
lt. 15

29 1/2" x 25 5/8"
H 7 1/2"
gal. 3 7/8

438

689

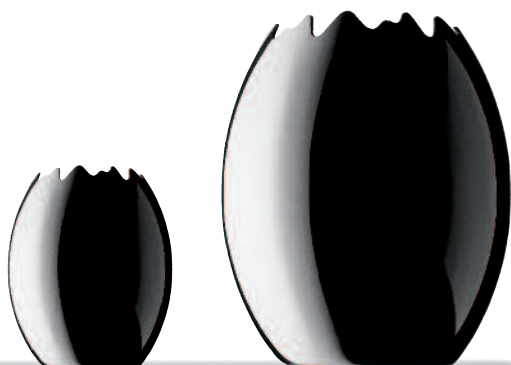

439

mm. 1,2

OVETTO
Secchiello per ghiaccio
Ice-bucket
Seau à glaçons
Eisgefäß
Cubitera hielo

Ø cm. 11
H cm. 13
cl. 100

Ø 4 3/8"
H 5 1/8"
oz. 33 7/8

OVO
Secchiello per spumante
Sparkling wine cooler
Seau à champagne
Wein- und Sektkühler
Cubo para champany

Ø cm. 19
H cm. 22
lt. 4,5

Ø 7 1/2"
H 8 5/8"
gal. 1 1/4



688

mm. 1,2

Secchiello per ghiaccio
Ice-bucket
Seau à glaçons
Eisgefäß
Cubitera hielo

Ø cm. 11
H cm. 12,5
cl. 55

Ø 4 3/8"
H 4 7/8"
oz. 18 5/8

mm. 1,2

Secchiello per spumante
Sparkling wine cooler
Seau à champagne
Wein- und Sektkühler
Cubo para champany

Ø cm. 19
H cm. 20
lt. 2,5

Ø 7 1/2"
H 7 3/4"
oz. 84 1/2

598



607



597

mm. 1,2 | Cestini
Baskets
Corbeilles
Früchtekorben
Cestas

598
Ø cm. 29 | Ø 11 3/8"
H cm. 18,5 | H 7 1/4"
lt. 8 | gal. 2

607
Ø cm. 27 | Ø 10 1/2"
H cm. 13,5 | H 5 1/4"
lt. 5 | gal. 1 1/3

597
Ø cm. 16,8 | Ø 6 5/8"
H cm. 11 | H 4 3/8"
cl. 150 | oz. 50 3/4

666C

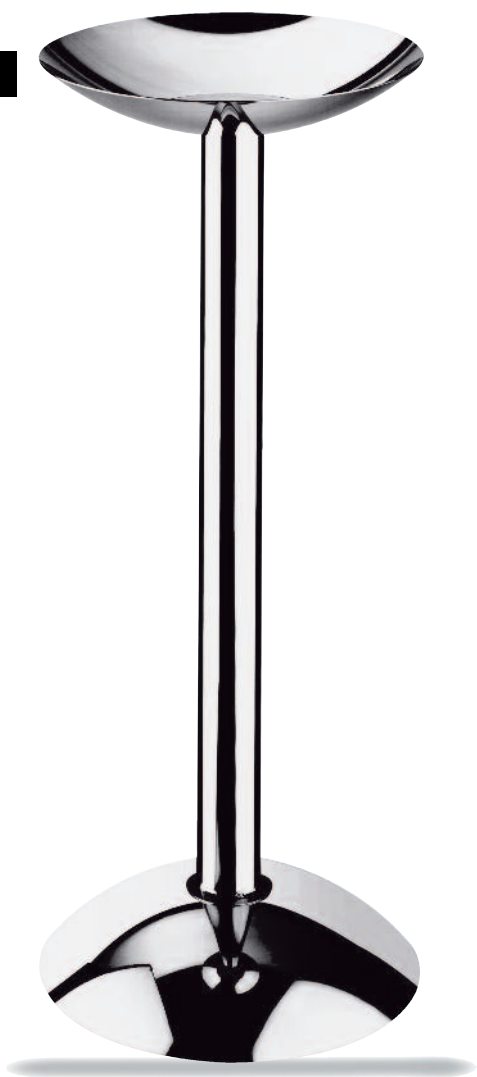

912



909

mm. 1,2
Secchiello per spumante
Sparkling wine cooler
Seau à champagne
Wein- und Sektkühler
Cubo para champany

cm. 39 x 36
H cm. 17,5
lt. 6
15 3/8" x 14 1/4"
H 7"
gal. 1 3/5

mm. 1,2
Secchiello per ghiaccio
Ice-bucket
Seau à glaçons
Eisgefäß
Cubitera hielo

cm. 22 x 20
H cm. 11,5
lt. 1,2
H 4 5/8"
8 3/4" x 7 7/8"
oz. 40 1/2

910



899

mm. 1,2 | Colonna portasecchiello spumante UNO | H cm. 65 | H 25 5/8"
Wine cooler stand »
Pied pour seau à champagne »
Weinkühlerständer »
Columna porta cubo champany »

mm. 1,2
Secchiello per spumante
Sparkling wine cooler
Seau à champagne
Wein- und Sektkühler
Cubo para champany

cm. 39 x 36
H cm. 17,5
lt. 7
15 3/8" x 14 1/4"
H 7"
gal. 1 4/5

mm. 1,2
Secchiello per ghiaccio
Ice-bucket
Seau à glaçons
Eisgefäß
Cubitera hielo

cm. 22 x 20
H cm. 11,5
lt. 1,6
8 3/8" x 7 7/8"
H 4 5/8"
oz. 54

570



mm. 1,2 | Cremiera
Cream jug
Crémier
Sahnegießer/Milchkännchen
Jarrita lechera

Ø cm. 6 | Ø 2 3/8"
H cm. 8,8 | H 3 1/2"
cl. 16 | oz 5 3/8

571



mm. 1,2 | Zuccheriera
Sugar bowl
Sucriere
Zuckerdose
Azucarero

Ø cm. 9,5 | Ø 3 3/4"
H cm. 6,8 | H 2 3/4"
cl. 20 | oz 6 3/4

514

NEW

514S

514P



mm. 0,8 | GIOTTO
Spargisale e Spargipepe
Salt and pepper cellar
Salière et poivrère
Salz und Pepper-streuer
Salero y pimentero

Ø cm. 3 | Ø 1 1/6"
H cm. 3 | H 1 1/6"
cl. 5 | oz. 1 2/3

999C

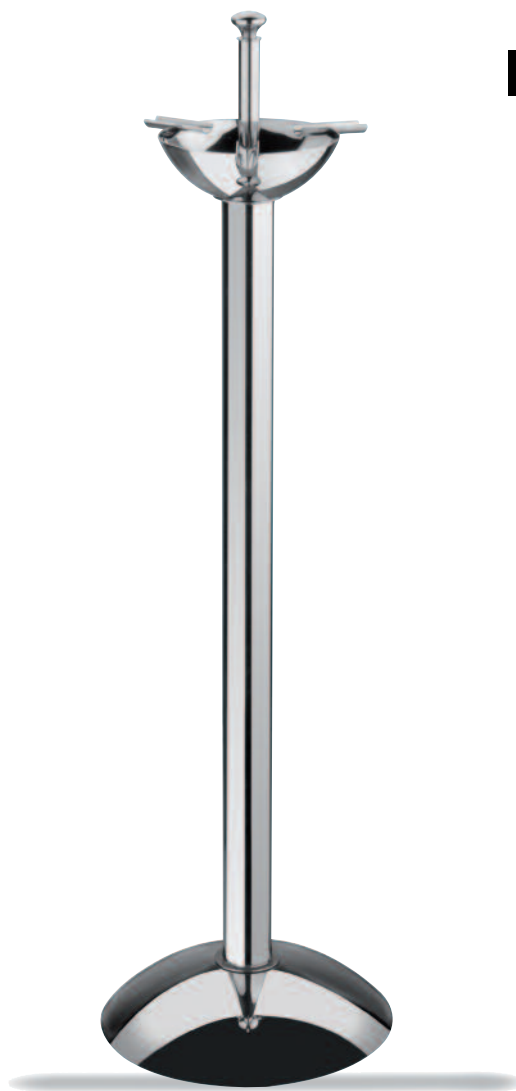

719

NEW



mm. 1,2 | Bicchiere termico
Insulated shot glass
Shot-verre thermique
Warmhalter Shot Glass
Vaso térmico por chupito

Ø cm. 5 Est. | Ø 2" Out.
Ø cm. 4 Int. | Ø 1 3/5" Ins.
H cm. 6,3 | H 2 1/2"
cl. 6 | oz. 2

mm. 1,2 | Posacenere a colonna
Ashtray column
Borne étouffoir
Ascherständer
Cenicero à columna

H cm 91,5 | H 36"

26202



mm. 1,2	Centrotavola/Fruttieria ovale 2p	cm. 46 x 31	18 ¹ / ₈ " x 12 ¹ / ₄ "
	Elevated centerpiece/Fruit-bowl	cm. 37 x 25	14 ¹ / ₂ " x 9 ⁷ / ₈ "
	Centre de table/Compotier	H cm. 28	H 11 ¹ / ₈ "
	Tafelaufsatz/Obstschale	lt. 6,5	gal. 1 ⁵ / ₇
Centro de mesa/Fruterio			

242



mm. 1,2	Centrotavola/Fruttieria tonda	Ø cm.32	Ø 12 ⁵ / ₈ "
	Elevated centerpiece/Fruit-bowl	H cm. 19	H 7 ¹ / ₂ "
	Centre de table/Compotier	lt. 3,0	oz. 101 ² / ₅
	Tafelaufsatz/Obstschale		
Centro de mesa/Fruterio			

26203



mm. 1,2	Centrotavola/Fruttieria ovale 3p	cm. 46 x 31	18 ¹ / ₈ " x 12 ¹ / ₄ "
	Elevated centerpiece/Fruit-bowl	cm. 37 x 25	14 ¹ / ₂ " x 9 ⁷ / ₈ "
	Centre de table/Compotier 3et.	Ø cm. 12	Ø 4 ³ / ₄ "
	Tafelaufsatz/Obstschale 3-Stu.	H cm. 37	H 14 ¹ / ₂ "
Centro de mesa/Fruterio 3pisos			
		lt. 6,7	gal. 1 ³ / ₄

24202



mm. 1,2	Centrotavola/Fruttieria tonda 2 piani	Ø cm. 32	Ø 12 ⁵ / ₈ "
	Elevated centerpiece/Fruit-bowl 2t	Ø cm. 22	Ø 8 ⁵ / ₈ "
	Centre de table/Compotier 2 et.	H cm. 29,5	H 11 ³ / ₅ "
	Tafelaufsatz/Obstschale 2-Stufig	lt. 4,3	gal. 1 ¹ / ₈
Centro de mesa/Fruterio 2 pisos			

26204



mm. 1,2	Centrotavola/Fruttieria ovale 4p	cm. 55 x 24	21 ⁵ / ₈ " x 9 ¹ / ₂ "
	Elevated centerpiece/Fruit-bowl	cm. 46 x 31	18 ¹ / ₈ " x 12 ¹ / ₄ "
	Centre de table/Compotier 4et.	cm. 37 x 25	14 ¹ / ₂ " x 9 ⁷ / ₈ "
	Tafelaufsatz/Obstschale 4-Stu.	Ø cm. 12	Ø 4 ³ / ₄ "
Centro de mesa/Fruterio 4pisos			
		H cm. 49	H 19 ¹ / ₃ "
		lt. 7,2	gal. 2

NEW

871



mm. 1,2	Cestino portafrutta	cm. 24 x 11	9 ¹ / ₂ " x 4 ¹ / ₃ "
	Fruit basket		
	Bol à fruits		
	Fruchtschale		
Cesto porta frutas			

565



mm. 1,2	Completo oliera con spargisale Cruet and salt cellar set Service huile-vinaigre Essig-/Ölgestell 4-tlg Convoy vinagreras con saleros	cm. 15x15 H cm. 12 cl. 18(x2) cl. 11(x2)	5 ⁷ / ₈ " x 5 ⁷ / ₈ " H 7 1 ¹ / ₂ " oz. 6 ¹ / ₈ (x2) oz. 3 ³ / ₄ (x2)
---------	--	---	--

566



mm. 1,2	Formaggera Parmesan cheese basin Fromagère Käsedose Quesera-Azucarero	cl. 20	oz. 6 ³ / ₄
---------	---	--------	-----------------------------------

577

578



Coppetta tonda in vetro Individual bowl in glass Petit bol en verre Glasschale rund Tazon en vidrio	Ø cm. 12 H cm. 7,4 cl. 40 Ø 4 3 ⁴ / ₄ " H 2 ⁷ / ₈ " oz. 13 ¹ / ₂	Insalatiera in vetro Salad bowl in glass Bol pour salade en verre Glassalatschale Ensaladera en vidrio	Ø cm. 21,5 H cm. 14 cl. 220 Ø 8 1 ¹ / ₂ " H 5 ¹ / ₂ " oz. 74 ³ / ₈
---	---	--	---

584



Coppetta quadra in vetro Glass square bowl Coupe carré en verre Glasschälchen quadratisch Cuenco cuadrado en vidrio	mm. 1,2	Coperchio per coppetta quadra Lid for square bowl Couvercle pour coupe carré Deckel für Schälchen quadratisch Tapa par cuenco cuadrado
cm. 10 x 10 - cl. 27 3 7 ⁷ / ₈ " x 3 7 ⁷ / ₈ " - oz. 9 ¹ / ₈		cm. 10 x 10 3 7 ⁷ / ₈ " x 3 7 ⁷ / ₈ "

572



572A

Ampolla Cruet Huilliere Essig-/Ölflasche mit Spender Vinagrera	cl. 20 cl. 34 cl. 62	oz. 6 3 ⁴ / ₄ oz. 11 1 ¹ / ₂ oz. 21	Bottiglia Glass bottle Bouteille Glasflasche mit Stopfen Botella
---	----------------------------	---	--

572



Le nostre ampolle sono il sistema più igienico di versare le arachidi perché si evita di mettere le mani nel contenitore
Our glass bottles can be used to serve peanuts hygienically and without hand contact
Notre bouteille en verre est le système le plus igiénique et pratique pour verser les arachides et éviter de mettre les mains dans les conteniteur
Unsere formschöne Glaskaraffe eignet sich auch bestens als alternativer Spender für Erdnüsse. Eine Einladung für die Gäste, die die Erdnüsse nunmehr bequem dosieren können; somit wird ein direkter Kontakt mit den Fingern vermieden
Nuestras jarras tienen el sistema mas higiénico, de verter los cacahuets, porque se evita meter las manos en el recipiente



FINGER FOOD

557T



557

557T

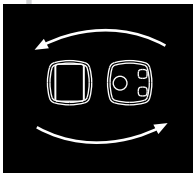

Combinabile con
Ciotole in vetro
Ciotole in policarbonato
Ciotole in porcellana
Coperchio in acciaio
inossidabile 18/10

Combinable with
Glass bowls
Polycarbonate bowls
China bowls
18/10 st.st. lid

Combinable avec
Bols en verre
Bols en Polycarbonat
Bols en porcelaine
Couvercle en acier
inoxydable18/10

Kombinierbar mit
Glasschalen
Polycarbonatschalen
Porzellanschalen
18/10-Deckel

Combinable con
Cuencos en cristal
Cuencos en policarbonato
Cuencos en China
Tapa en acero inoxidable
18/10

561M



56138

561M

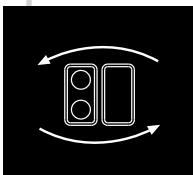

Combinabile con
Ciotole in vetro
Ciotole in policarbonato
Vassoio in acciaio
inossidabile 18/10

Combinable with
Glass bowls
Polycarbonate bowls
Tray in 18/10
stainless steel

Combinable avec
Bols en verre
Bols en Polycarbonat
Plateau en acier
inoxydable18/10

Kombinierbar mit
Glasschalen
Polycarbonatschalen
Edelstahlschalen

Combinable con
Cuencos en cristal
Cuencos en policarbonato
Cuencos en acero
inoxidable 18/10

561T



561T

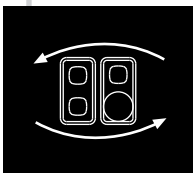

Combinabile con
Ciotole in vetro
Ciotole in policarbonato
Ciotole in porcellana
Coperchio in acciaio
inossidabile 18/10
Ampolle in vetro
Piatti in vetro

Combinable with
Glass bowls
Polycarbonate bowls
China bowls
18/10 st.st. lid
Glass bottles
Glass trays

Combinable avec
Bols en verre
Bols en Polycarbonat
Bols en porcelaine
Couvercle en acier
inoxydable18/10
Bouteilles en verre
Plateaus en verre

Kombinierbar mit
Glasschalen
Polycarbonatschalen
Porzellanschalen
18/10-Deckel
Karaffen
Glasplatten

Combinable con
Cuencos en cristal
Cuencos en policarbonato
Cuencos en China
Tapa en acero inoxidable
18/10
Botellas en vidrio
Platos en vidrio



56122

561M

561T

FINGER FOOD

563T15

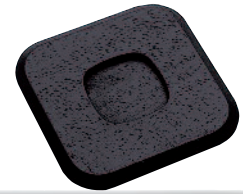

56315

563T15

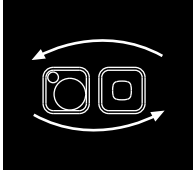

Combinabile con
Ciotole in vetro
Ciotole in policarbonato
Ciotole in porcellana
Coperchio in acciaio
inossidabile 18/10
Ampolle in vetro

Combinable with
Glass bowls
Polycarbonate bowls
China bowls
18/10 st.st. lid
Glass bottles

Combinable avec
Bols en verre
Bols en Polycarbonat
Bols en porcelaine
Couvercle en acier
inoxydable 18/10
Bouteilles en verre

Kombinierbar mit
Glasschalen
Polycarbonatschalen
Porzellanschalen
18/10-Deckel
Karaffen

Combinable con
Cuencos en cristal
Cuencos en policarbonato
Cuencos en China
Tapa en acero inoxidable
18/10
Botellas en vidrio

563T22



56322

563T22

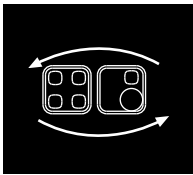

Combinabile con
Ciotole in vetro
Ciotole in policarbonato
Ciotole in porcellana
Coperchio in acciaio
inossidabile 18/10
Ampolle in vetro

Combinable with
Glass bowls
Polycarbonate bowls
China bowls
18/10 st.st. lid
Glass bottles

Combinable avec
Bols en verre
Bols en Polycarbonat
Bols en porcelaine
Couvercle en acier
inoxydable 18/10
Bouteilles en verre

Kombinierbar mit
Glasschalen
Polycarbonatschalen
Porzellanschalen
18/10-Deckel
Karaffen

Combinable con
Cuencos en cristal
Cuencos en policarbonato
Cuencos en acero
inoxidable 18/10
Botellas en vidrio

563T22



567

563T22

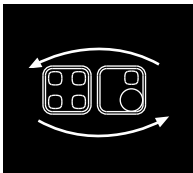

Combinabile con
Ciotole in vetro
Ciotole in policarbonato
Ciotole in porcellana
Coperchio in acciaio
inossidabile 18/10
Ampolle in vetro

Combinable with
Glass bowls
Polycarbonate bowls
China bowls
18/10 st.st. lid
Glass bottles

Combinable avec
Bols en verre
Bols en Polycarbonat
Bols en porcelaine
Couvercle en acier
inoxydable 18/10
Bouteilles en verre

Kombinierbar mit
Glasschalen
Polycarbonatschalen
Porzellanschalen
18/10-Deckel
Karaffen

Combinable con
Cuencos en cristal
Cuencos en policarbonato
Cuencos en acero
inoxidable 18/10
Botellas en vidrio



578

577

584

587

585

572

572A

352

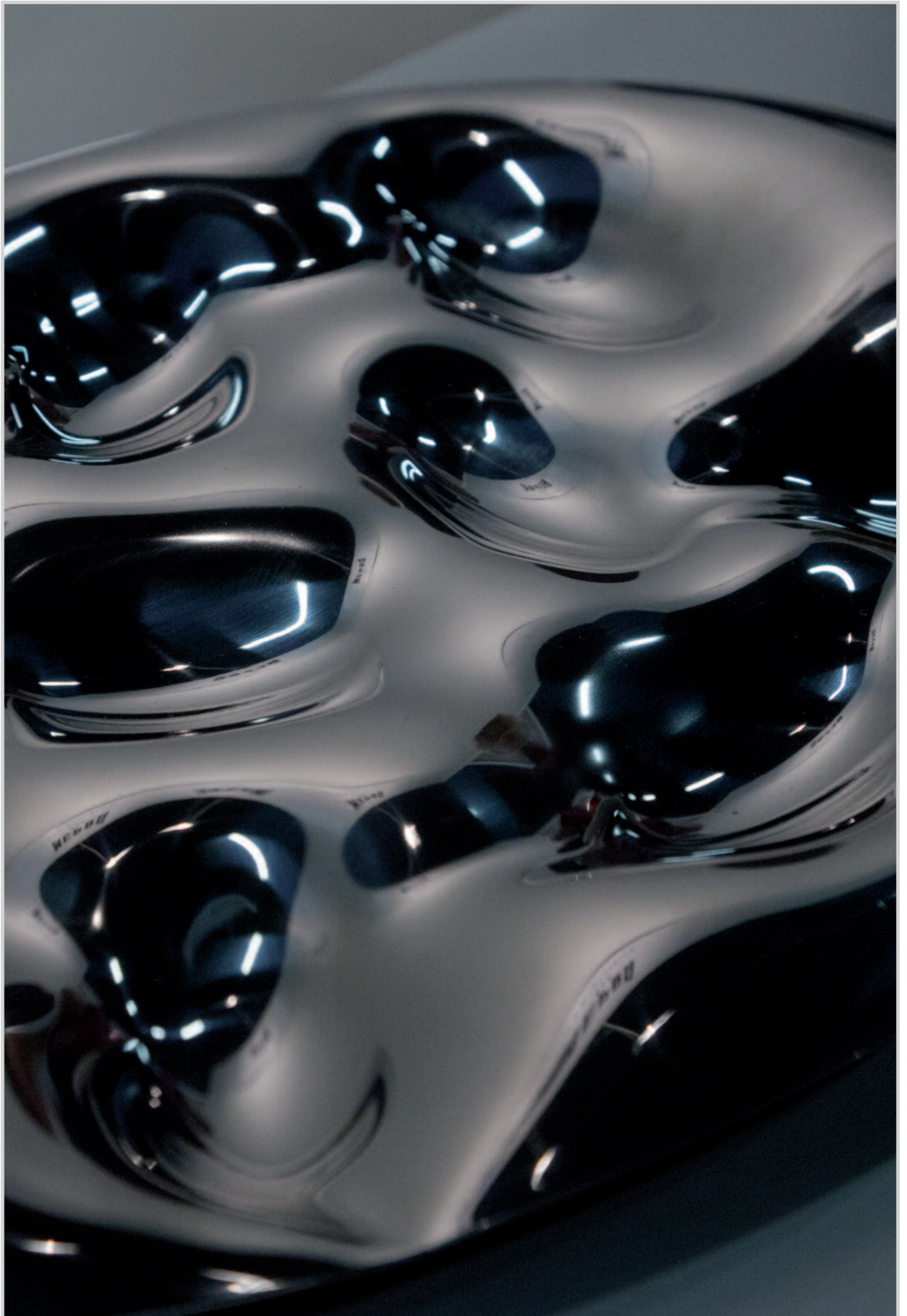

537

53706

53712



mm. 1,2	Mini vassoio quadro 6/12 comp. 6/12 comp. Mini square tray Mini plateau carré 6/12 pos. Mini Tablett, eckig., 6/12 Eins. Mini bandeja cuadrada 6/12 p.	cm. 12 x 12 cm. 15 x 15	4 3/4" x 4 3/4" 5 7/8" x 5 7/8"
---------	--	----------------------------	------------------------------------

549



mm. 1,2	Vassoio rettangolare 14 comp. Rectangular tray 14 comp. Plateau rectangulaire 14 plac. Tablett, rechteckig 14 Eins. Bandeja rectangular 14 posic.	cm 45 x 28	17 3/4" x 11 1/8"
---------	---	------------	-------------------

520

NEW



mm. 1,2	Vassoio ovale 9 compart. Oval tray 9 compartments Plateau oval 9 comp. Tablett, oval, 9 Einsätze Bandeja oval 9 posiciones	cm. 35 x 25,5	13 3/4" x 10"
---------	--	---------------	---------------

NEW

791E

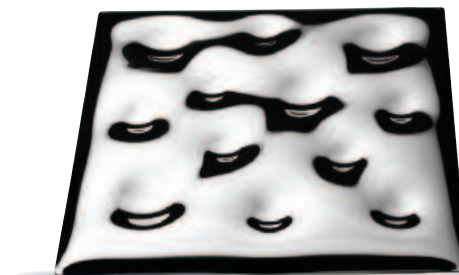

mm. 1,2	Vassoio da buffet per uova Egg tray for buffet Plateau à oeufs pour buffet Egg-tablett für Buffet Bandeja porta huevos por buffet	cm. 30 x 30	11 7/8" x 11 7/8"
---------	---	-------------	-------------------

52922



mm. 1,2	Vassoio quadro 8 compart. 8 comp. Square tray Plateau carré 8 pos. Tablett, eckig., 8 Eins. Bandeja cuadrada 8 posic.	cm. 22 x 22	8 5/8" x 8 5/8"
---------	---	-------------	-----------------

526

04

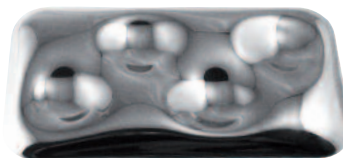

03



mm. 1,2	Vassoio rettangolare a 3 o 4 comp. Rectangular tray 3 or 4 comp. Plateau rectangulaire 3 ou 4 plac. Tablett, rechteckig 3 oder 4 Eins. Bandeja rectangular 3 o 4 posic.	cm. 23 x 13	9" x 5 1/8"
---------	---	-------------	-------------



10001129

NEW



mm. 2,5 | Quarta posata | Lungh. cm. 22,2 | Length 8 3/4"

530



mm. 1,2 | Mini vaporiera
Mini steamer
Mini vaporisateur
Mini Verdampfer
Mini vaporizador

Ø cm. 12	Ø 4 3/4"
H cm. 14,5	H 5 3/4"
cl. 24	oz. 8
Ø cm. 32	Ø 12 5/8"
H cm. 26	H 10 1/4"
lt. 3,0	oz. 101 2/5

NEW



282

mm. 1,2 | Braciere con pietre naturali
Table grill with natural stones
Brasier avec pierres naturelles
Feuerschale mit Natursteine
Hoguera c/piedras naturales

Ø cm. 15	Ø 5 7/8"
Ø cm. 22	Ø 8 5/8"
Ø cm. 32	Ø 12 5/8"

791AC



mm. 1,2 | Inserto per finger food
Finger food insert
Insért pour finger food
Finger food Einsatz
Inserto por finger food

cm. 30 x 30	117/8" x 117/8"
-------------	-----------------

See colors page 126

791



Vassoio/Sottopiatto
Square Tray/Charger
Plateau/Assiette de bienvenue
Tablett/Platzteller,
Bandeja/Bajo plato

cm. 32 x 32	12 3/4" x 12 3/4"
-------------	-------------------





252



mm. 1,2 | Centrotavola/Fruittiera
Elevated centerpiece/Fruit-bowl
Centre de table/Compotier
Tafelaufsatz/Obstschale
Centro de mesa/Fruterio

cm.38 x 25 | 15" x 9 7/8"
H cm. 18 | H 7 1/8"
cl. 300 | oz. 101 1/2

252G



mm. 1,2 | Alzata per pesce crudo
Elevated rect.seafood presentation
Serveur à poisson crude
Etagere für marinierten Fisch
Porta pescado

cm.38 x 25 | 15" x 9 7/8"
H cm. 18 | H 7 1/8"
cl. 300 | oz. 101 1/2

562/V



Rettangolare fondo con vassoio
Rectangular cooling bowl for buffet with insert
Bol rectangulaire à rafraichir avec insert
Kühlschale, rechteckig mit Einsatzteile
Bandeja refrescante rectangular con inserto

cm. 38 x 25 | 15" x 9 7/8"
cl. 300 | oz. 101 1/2

562/G



Rettangolare fondo con griglia
Elevated rect.seafood presentation with grill
Bol rectangulaire à rafraichir avec grill
Kühlschale, rechteckig mit Einsatzsieb
Bandeja refrescante rectangular con rejilla

cm. 38 x 25 | 15" x 9 7/8"
cl. 300 | oz. 101 1/2

56422N



Quadro fondo con vassoio
Square cooling bowl for buffet with insert
Bol carré à rafraichir avec insert
Kühlschale, quadr. mit Einsatzteile
Bandeja refrescante cuadrada con inserto

cm. 22x22 | 8 5/8" x 8 5/8"
cl. 150 | oz. 50 3/4

56422/G



Quadro fondo con griglia
Square individual seafood presentation with grill
Bol carré à rafraichir avec grill
Kühlschale, quadr. mit Einsatzsieb
Bandeja refrescante cuadrada con rejilla

cm. 22x22 | 8 5/8" x 8 5/8"
cl. 150 | oz. 50 3/4

262G



mm. 1,2 | Alzata per pesce crudo
Elevated oval seafood
presentation with grill
Serveur à poisson crude
Etagere für marinierten Fisch
Porta pescado

cm. 46 x 31 | 18 1/8" x 12 1/4"
H cm. 18 | H 7 1/8"
cl. 400 | gal. 1

262



mm. 1,2 | Centrotavola/Frutiera
Elevated centerpiece/Fruit-bowl
Centre de table/Compotier
Tafelaufsatz/Obstschale
Centro de mesa/Fruterio

cm. 46 x 31 | 18 1/8" x 12 1/4"
H cm. 18 | H 7 1/8"
cl. 400 | gal. 1

558/V



Ovale fondo con vassoio
Oval cooling bowl for buffet with insert
Bol oval à rafraichir avec insert
Kühlschale, oval mit Einsatzteile
Bandeja refrescante oval con inserto

cm. 46 x 31 | 18 1/8" x 12 1/4"
cl. 400 | gal. 1

558/G



Ovale fondo con griglia
Oval seafood presentation with grill
Bol oval à rafraichir avec grill
Kühlschale, oval mit Einsatzsieb
Bandeja refrescante oval con rejilla

cm. 46 x 31 | 18 1/8" x 12 1/4"
cl. 400 | gal. 1

56022/G



Tondo fondo con griglia
Round individual seafood presentation with grill
Bol ronde à rafraichir avec grill
Kühlschale, rund mit Einsatzsieb
Bandeja refrescante redonda con rejilla

Ø cm. 22 | cl. 150
Ø cm. 8 5/8"
oz. 50 3/4

56022/V



Tondo fondo con vassoio
Round cooling bowl for buffet with insert
Bol ronde à rafraichir avec insert
Kühlschale, rund mit Einsatzteile
Bandeja refrescante redonda con inserto

Ø cm. 22 | cl. 150
Ø cm. 8 5/8"
oz. 50 3/4

242G



mm. 1,2	Alzata tonda per pesce crudo	Ø cm.32	Ø 12 5/8"
	Elevated round thirty-two stand	H cm. 19	H 7 1/2"
	Serviteur ronde à poisson crude	lt. 3,0	oz. 101 2/5
	Etagere, rund, für marinierte Fisch		
	Porta pescado redondo		

26202G



mm. 1,2	Alzata ovale per pesce crudo 2p	cm. 46 x 31	18 1/8" x 12 1/4"
	Oval two tier seafood stand	cm. 37 x 25	14 1/2" x 9 7/8"
	Serviteur ovale à poisson crude	H cm. 28	H 11 1/8"
	Etagere, oval, für marinierten Fisch	lt. 6,5	gal. 1 5/7
	Porta pescado oval 2 pisos		

24202G



mm. 1,2	Alzata tonda per pesce crudo 2p	Ø cm. 32	Ø 12 5/8"
	Round two tier seafood stand	Ø cm. 22	Ø 8 5/8"
	Servit.ronde à poisson crude 2 et.	H cm. 29,5	H 11 3/5"
	Etagere, rund, für marinierte Fisch	lt. 4,3	gal. 1 1/8
	2-Stufig		
	Porta pescado redondo 2 pisos		

26203G



mm. 1,2	Alzata ovale per pesce crudo 3p	cm. 46 x 31	18 1/8" x 12 1/4"
	Oval three tier seafood stand	cm. 37 x 25	14 1/2" x 9 7/8"
	Serviteur ovale à poisson crude	Ø cm. 12	Ø 4 3/4"
	Etagere, oval, für marinierten Fisch	H cm. 37	H 14 1/2"
	3-Stufig	lt. 6,7	gal. 1 3/4
	Porta pescado oval 3 pisos		

485

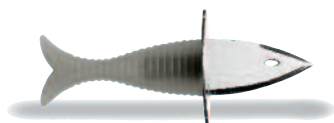

APRIL	cm. 15	5 7/8"
Coltello per ostriche		
Oyster knife		
Couteau à huîtres		
Austernöffner		
Cuchillo de ostras		

26204G



mm. 1,2	Alzata ovale per pesce crudo 4p	cm. 55 x 24	21 5/8" x 9 1/2"
	Oval four tier seafood stand	cm. 46 x 31	18 1/8" x 12 1/4"
	Serviteur ovale à poisson crude	cm. 37 x 25	14 1/2" x 9 7/8"
	Etagere, oval, für marinierten Fisch	Ø cm. 12	Ø 4 3/4"
	4-Stufig	H cm. 49	H 19 1/3"
	Porta pescado oval 4 pisos	lt. 7,2	gal. 2

235G



mm. 1,2 Vassoio rotondo per pesce crudo
Round seafood tray
Plateau rond à poisson crude
Tablett, rund für marinierten Fisch
Porta pescado redondo

Ø cm.38
H cm. 9
lt. 3,0

Ø 15"
H 3 1/2"
oz. 101 2/5

235



mm. 1,2 Centrotavola/Fruittiera
Centerpiece/Fruit-bowl
Centre de table/Compotier
Tafelaufsatz/Obstschale
Centro de mesa/Fruterio

Ø cm.38
H cm. 9
lt. 3,0

Ø 15"
H 3 1/2"
oz. 101 2/5





804



TRE
Portacondimenti
Basket for aromatic condiments
Corbeille pour aromatiques condiments
Tisch-Essig/Öl-Flaschenhalter
Cesto para aromaticos y condimentos

cm. 15 x 15 | 6" x 6"
H cm. 19,6 | H 7 3/4"

799



TRE
Ciotola quadra
Square bowl
Bol, carré
Universalschale auf Holz, quadratisch
Cuenco cuadrado

cm. 6 x 6 | 2 3/8" x 2 3/8"

599

58928

12 colori disponibili - pag. 253
12 colors available - page 253
12 couleurs disponibles - pag. 253
12 verschiedenen Farben verfügbar - Seite 253
12 colores disponibles - pag. 253

589 - Ø cm. 28
Ø 11"



mm. 1,2 | UNO
Cestino traforato
Fretworked basket
Corbeille, ajourée
Früchtekorb gelocht
Cesta perforada

Ø cm. 29 | Ø 11 3/8"
H cm. 18,5 | H 7 1/4"
lt. 8 | gal. 2

666B



TRE
Colonna portasecchiello
Wine cooler stand
Pied pour seau à champagne
Weinkühlerständer
Columna porta cubo champany

H cm. 65 | H 25 5/8"

792



TRE
Vassoio rettangolare
Rectangular tray
Plateau rectangulaire
Tablett, rechteckig
Bandeja rectangular

cm. 50 x 32 | 19 3/4" X 12 3/4"
cm. 30 x 20 | 11 3/4" X 7 7/8"

788

NEW



QUATTRO
Vassoio rettangolare
Rectangular tray
Plateau rectangulaire
Tablett, rechteckig
Bandeja rectangular

cm. 50 x 32 | 19 3/4" X 12 3/4"
cm. 30 x 20 | 11 3/4" X 7 7/8"

791



TRE
Vassoio/Sottopiatto
Square Tray/Charger
Plateau/Assiette de bienvenue
Tablett/Platzteller,
Bandeja/Bajo plato

cm. 32 x 32 | 12 3/4" x 12 3/4"

789

NEW



QUATTRO
Vassoio/Sottopiatto
Square Tray/Charger
Plateau/Assiette de bienvenue
Tablett/Platzteller,
Bandeja/Bajo plato

cm. 32 x 32 | 12 3/4" x 12 3/4"

795



TRE
Tovaglietta americana
Place mat
Set de table
americain en bois
Tischset aus Holz
individual en madera

cm. 38 x 28 | 15" x 11"

796



TRE
Sottopiatto
Charger
Assiette de bienvenue
Platzteller
Bajo plato

Ø cm. 33 | Ø 13"

787

787

NEW



TRE
Vassoio per prima colazione
Breakfast tray
Plateau rect. pour le petit déjeuner
Frühstück Tablett, rechteckig
Bandeja rect. por desayuno

cm. 30 x 20 | 11 3/4" X 7 7/8"

791AC



Inserto Finger Food per vassoio quadro e rettangolare
Finger Food insert for square and rectangular tray
Insért Finger Food pour plateau carré et rectangulaire
Finger Food-Einsatz für quadratische/rechteckig Schale
Inserto para Finger Food por bandeja cuadrada y rectangular

cm. 30 x 30 | 11 7/8" x 11 7/8"

793

794



TRE
Completo oliera con spargisale
Cruet and salt cellar set
Huile-vinaigre 4 pcs
Essig-/Öl-Menage 4-Tlg.
Vinagreras con saleros

cm. 15 x 15 | 6" x 6"
H cm. 19,6 | H 7 3/4"
cl. 30 (x2) | oz. 10 1/8 (x2)
cl. 8 (x2) | oz. 2 3/4 (x2)



TRE
Formaggera
Parmesan cheese basin
Fromagère
Käsedose
Quesera Azucarero

cm. 15 x 15 | 6" x 6"
cl. 20 | oz. 6 3/4



W Bianco
White
Blanc
Weiss
Blanco

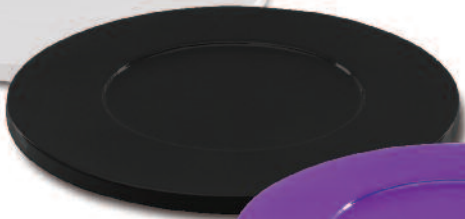

N Nero
Black
Noir
Schwarz
Negro



V7 Viola
Violet
Violet
Pflaume
Violeta



O Arancio
Orange
Orange
Orange
Naranja



L7 Lime
Lime
Lime
Limone
Lima



A Noce
Walnut
Noyer
Walnuss
Nuez

N E W



N E W

R Rovere
Oak
Chêne
Eiche
Roble



W Wengé



792



TRE
Vassoio rettangolare
Rectangular tray
Plateau rectangulaire
Tablett, rechteckig
Bandeja rectangular

cm. 50 x 32 | 19 3/4" X 12 3/4"
cm. 30 x 20 | 11 3/4" X 7 7/8"

NEW

788



QUATTRO
Vassoio rettangolare
Rectangular tray
Plateau rectangulaire
Tablett, rechteckig
Bandeja rectangular

cm. 50 x 32 | 19 3/4" X 12 3/4"
cm. 30 x 20 | 11 3/4" X 7 7/8"

791



TRE
Vassoio/Sottopiatto
Square Tray/Charger
Plateau/Assiette de bienvenue
Tablett/Platzteller,
Bandeja/Bajo plato

cm. 32 x 32 | 12 3/4" x 12 3/4"

NEW

789



QUATTRO
Vassoio/Sottopiatto
Square Tray/Charger
Plateau/Assiette de bienvenue
Tablett/Platzteller,
Bandeja/Bajo plato

cm. 32 x 32 | 12 3/4" x 12 3/4"

795



TRE
Tovaglietta americana
Place mat
Set de table
americain en bois
Tischset aus Holz
individual en madera

cm. 38 x 28 | 15" x 11"

796



TRE
Sottopiatto
Charger
Assiette de bienvenue
Platzteller
Bajo plato

Ø cm. 33 | Ø 13"

787



NEW

787

TRE
Vassoio per prima colazione
Breakfast tray
Plateau rect. pour le petit déjeuner
Frühstück Tablett, rechteckig
Bandeja rect. por desayuno

cm. 30 x 20 | 11 3/4" X 7 7/8"

791AC



Inserto Finger Food per vassoio quadro e rettangolare
Finger Food insert for square and rectangular tray
Insért Finger Food pour plateau carré et rectangulaire
Finger Food-Einsatz für quadratische/rechteckig Schale
Inserto para Finger Food por bandeja cuadrada y rectangular

cm. 30 x 30 | 11 7/8" x 11 7/8"

802

801



TRE
Portagioie/Portapasticcini
Jewel case/Petit fours case
Porte bijoux/Porte petit patisserie
Schmuckablage/Bonbonträger
Joyero/Porta dulces

cm. 15 x 15 | 6" x 6"

794



Formaggera
Parmesan cheese basin
Fromagère
Käsedose
Quesera Azucarero

cm. 15 x 15
cl. 20
6" x 6"
oz. 6 3/4

793



Completo oliera con spargisale
Cruet and salt cellar set
Huile-vinaigre 4 pcs
Essig-/Öl-Menage 4-Tlg.
Vinagreras con saleros

cm. 15 x 15
H cm. 19,6
cl. 30 (x2)
cl. 8 (x2)
6" x 6"
H 7 3/4"
oz. 10 1/8 (x2)
oz. 2 3/4 (x2)

804



Portacondimenti
Basket for aromatic condiments
Corbeille pour aromatiques condiments
Tisch-Essig/Öl-Flaschenhalter
Cesto para aromaticos y condimentos

cm. 15 x 15
H cm. 19,6
6" x 6"
H 7 3/4"



3504



S7

BARCELONA

S7



3404

J



Ø cm. 12,5

Ø 5"

J



cm. 14 x 14

5 1/2" x 5 1/2"

3503



F7

AMSTERDAM

F7



3403

N7



Ø cm. 12,5

Ø 5"

N7



cm. 14 x 14

5 1/2" x 5 1/2"

3505



H7

BERLIN

H7



3405

Q7



Ø cm. 12,5

Ø 5"

Q7

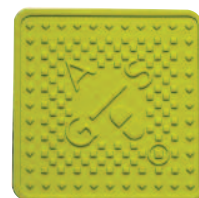

cm. 14 x 14

5 1/2" x 5 1/2"



STREET COVER

3200

S7



S7



S7



ROMA

J

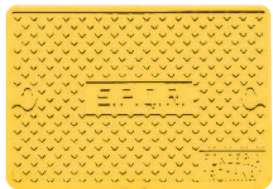

J



J



cm. 30 x 45

11 3/4" x 17 3/4"

Ø cm. 17
Ø cm. 35

Ø 6 3/4"
Ø 13 7/8"

cm. 45 x 45

17 3/4" x 17 3/4"

3202

F7



F7



F7



LONDON

N7



N7



N7



cm. 30 x 45

11 3/4" x 17 3/4"

Ø cm. 17
Ø cm. 35

Ø 6 3/4"
Ø 13 7/8"

cm. 45 x 45

17 3/4" x 17 3/4"

3201

H7



H7



H7



PARIS

Q7



Q7



Q7



cm. 30 x 45

11 3/4" x 17 3/4"

Ø cm. 17
Ø cm. 35

Ø 6 3/4"
Ø 13 7/8"

cm. 45 x 45

17 3/4" x 17 3/4"



845



84501



84504



843

856

mm. 1,2 | Portaghiaccio termico con coperchio
Insulated ice-bucket with lid
Seau à glaçons thermique
avec couvercle
Isolier-Eisgefäß, mit Deckel
Cubitera hielo con tapa

Ø cm 14	Ø 5 1/2"
H cm 13	H 5"
cl. 72	oz. 24 1/3
Ø cm 24	Ø 9 1/2"
H cm 22	H 8 5/8"
lt. 4,0	gal. 1

mm. 1,2 | Secchiello per spumante
Sparkling wine cooler
Seau à champagne
Wein- und Sektkühler
Cubo para champany

Ø cm 24	Ø 9 1/2"
H cm 22	H 8 5/8"
lt. 4,0	gal. 1
Ø cm 14	Ø 5 1/2"
H cm 13	H 5"
cl. 125	oz. 42 1/4

666G

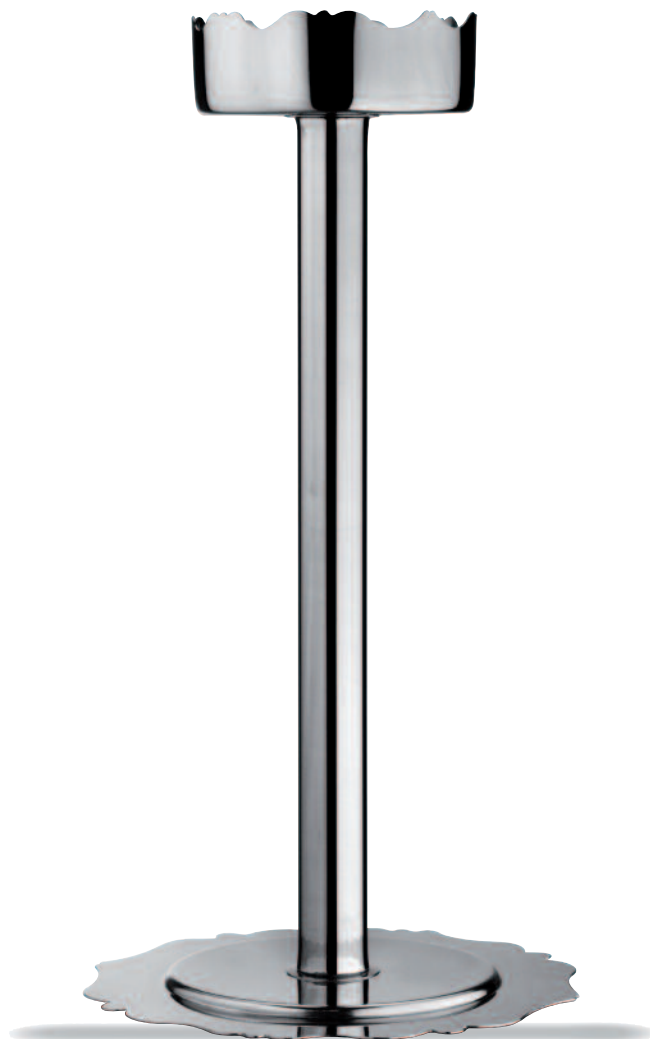

mm. 1,2 | Colonna portasecchiello spumante
Wine cooler stand
Pied pour seau à champagne
Weinkühlerständer
Columna porta cubo champany

H cm. 62	H 24 3/8"
----------	-----------

800



mm. 1,2	Vassoio rettangolare c/interno ovale Rectangular tray, w/oval int.part Plateau rectangulaire a/partie interne ovale Tablett rechteckig mit ovaler Innenform Bandeja rectangular con la parte interna ovalada	cm. 47x34 cm. 56x40	18 ¹ / ₂ " x 13 ³ / ₈ " 22" x 15 ³ / ₄ "
---------	--	------------------------	---

808



mm. 1,2	Vassoio quadro con interno tondo Square tray, w/round internal part Plateau carré a/partie interne ronde Tablett quadratisch mit runder Innenform Bandeja cuadrada c/la parte interna redonda	cm. 40x40	15 ³ / ₄ " x 15 ³ / ₄ "
---------	---	-----------	---

801



mm. 1,2	Vassoio rettangolare c/int.ovale c/piedini Rect.tray, w/oval int.part and feet Plateau rect.a/partie ovale int. sur pied Tablett rechteckig mit ovaler Innenform und Füßen Bandeja rect.c/parte int.oval.y pies	cm. 47x34 cm. 56x40	18 ¹ / ₂ " x 13 ³ / ₈ " 22" x 15 ³ / ₄ "
---------	---	------------------------	---

809



mm. 1,2	Vassoio quadro c/int.tondo c/piedini Square tray, w/round int.part w/feet Plat.carré a/partie int.ronde s/pied. Tablett quadratisch mit runder Innenform und Füßen Band.cuad.c/parte int.red.y 3 pies	cm. 40x40	15 ³ / ₄ " x 15 ³ / ₄ "
---------	---	-----------	---

802



mm. 1,2	Vassoio rett.c/int.ovale e pied. Rect.tray, w/oval int.part w/base Plateau rect.a/par.int. ovale s/socle Tablett rechteckig mit ovaler Innenform und Fuss Bandeja rect.c/parte int.oval. y pedestal	cm. 47x34 cm. 56x40 H cm. 14	18 ¹ / ₂ " x 13 ³ / ₈ " 22" x 15 ³ / ₄ " H 5 1/2"
---------	---	------------------------------------	---

807



mm. 1,2	Vassoio quadro c/int.tondo c/pied. Square tray, w/round int.part w/base Plat.carré a/partie int.ronde e/socle Petits Fours-Ständer Band.cuad.c/parte int.red.y pedest.	cm. 40x40 H cm. 18	15 3/4" x 15 3/4" H 7"
---------	--	-----------------------	---------------------------

805



mm. 1,2	Vassoio rettangolare Rectangular Tray Plateau rectangulaire Tablett rechteckig Bandeja rectangular	cm. 48 x 36	18 ⁷ / ₈ " x 14 ¹ / ₈ "
---------	--	-------------	---

861



mm. 1,2	Vassoio portalettere/portaconto Tray for correspondence, for bill Plateau à main Tablett für Korrespondenz oder Rechnungen Bandeja para la correspondencia o facturas	cm. 26 x 22	10" x 8 ¹ / ₂ "
---------	---	-------------	---------------------------------------

806



mm. 1,2	Vassoio rett.c/int.rett.con piedini Rect.tray, w/rect.int.part and feet Plateau rect.a/partie int.rect.s/pied Tablett rechteckig mit Füßen Bandeja rect.c/parte int.rect.c/4 pies	cm. 26x22 cm. 48x36	10" x 8 ¹ / ₂ " 18 ⁷ / ₈ " x 14 ¹ / ₈ "
---------	---	------------------------	--

862



mm. 1,2	Vassoio portalettere, portaconto con piedini Tray for correspondence, for bill w/feet Plateau à main sur pieds Tablett für Korrespondenz oder Rechnungen mit Füßen Bandeja para la correspondencia o facturas con 4 pies	cm. 26 x 22	10" x 8 ¹ / ₂ "
---------	---	-------------	---------------------------------------

810



mm. 1,2	Vassoio rett.c/int.rett.con piedist. Rect.tray, w/rect.int.part and base Plateau rect.a/partie int.rect.s/socle Tablett rechteckig mit Fuss Bandeja rect.c/parte int.rect.c/ped.	cm. 26x22 cm. 48x36 H cm. 14	10 x 8 ¹ / ₂ " 18 ⁷ / ₈ " x 14 ¹ / ₄ " H 5 ¹ / ₂ "
---------	--	------------------------------------	--

863



mm. 1,2	Vassoio portalettere, portaconto con piedistallo Tray for correspondence, for bill w/feet Plateau pour la correspondance ou factures sur socle Tablett für Korrespondenz od.Rechnungen m/Fuss Bandeja para la correspondencia o facturas c/ped.	26 x 22 H 13,5	10" x 8 ¹ / ₂ " H 5 ³ / ₈ "
---------	--	-------------------	--

860



mm. 1,2	Cestino rotondo	Ø cm. 18 cl. 110	Ø 7 1/8" oz. 37 1/5
	Round bowl Bol rond/Corbeille Obstschale, rund Cuenco redondo		

858



mm. 1,2	Ciotola finger food/amouse/bouche/burro	Ø cm. 8,5 cl. 28	Ø 3 3/8" oz 9 1/2
	Finger food/amouse bouche/butter bowl Bol multi-usages Fingerfood-/Vorspeisen-/Butter-Gefäß Cuenco para finger food/amouse bouche/mantequilla		

826



mm. 1,2	Cestino Basket Corbeille Obstschale Cuenco	cm. 13 x 13	5 1/8" x 5 1/8"
		cm. 16 x 16	6 3/8" x 6 3/8"
		cm. 32 x 32	12 5/8" x 12 5/8"

828



mm. 1,2	Centrotavola Centerpiece Centre de table Tafelaufsatz Centro de mesa	cm. 27 x 27	10 5/8" x 10 5/8"
		H cm. 7	H 2 7/8"
		lt. 2,4	oz. 94 2/3
		cm. 37 x 37	14 5/8" x 14 5/8"
		H cm. 7 lt. 4	H 2 7/8" gal. 1

827



mm. 1,2	Cestino con piedistallo Basket with base Corbeille sur socle Obstschale auf Fuss Cesta con pedestal	cm. 13 x 13	5 1/8" x 5 1/8"
		H cm. 19,5	H 7 5/8"
		cl. 85	oz. 28 3/4
		cm. 16 x 16	6 3/8" x 6 3/8"
		H cm. 23	H 9"
		cl. 172	oz. 58 1/7
	cm. 32 x 32	12 5/8" x 12 5/8"	
	H cm. 26,5	H 10 1/2"	
	lt. 4,82	gal. 1 1/4	

841



mm. 1,2	Piatto da torta con piedistallo Cakes plate with base Plat à tarte sur socle Kuchenplatte auf Fuß Bandeja tarta con pedestal	Ø cm. 30	Ø 11 7/8"
		Ø cm. 40	Ø 15 3/4"
		H cm. 16.5	H 6 1/2"

840



mm. 1,2	Portabustine/biglietti da visita Sugar packet/business card holder Porte cartes/sachets Zuckerstangengefäß-Kartenhalter Azucarera/Porta tarjetas comerciales	cm. 10 x 7	4 1/8" x 2 7/8"
---------	--	------------	-----------------

830



mm. 1,2	Svuotatasche Square basket Corbeille carré Brotkorb, quadratisch Cuenco cuadrado	cm. 15 x 15 cm. 22 x 22	5 7/8" x 5 7/8" 8 5/8" x 8 5/8"
---------	--	----------------------------	------------------------------------

848



mm. 1,2	Porta pasticcini Petit-fours stand Porte-petits fours Petits Fours-Ständer Porta dulces	Ø cm. 14 H cm. 9,5	Ø 5 1/2" H 3 3/4"
		Ø cm. 21 H cm. 14	Ø 8 1/4" H 5 1/2"

847



842



mm. 1,2	Porta pasticcini a 2 piani Petit-fours stand 2 layers Porte-petit fours 2 étages Mokkaétagerè 2 Ebenen Porta dulces 2 pisos	Ø cm. 14 Ø cm. 21 H cm 25,5	Ø 5 1/8" Ø 8 1/4" H 10"
---------	---	-----------------------------------	-------------------------------

mm. 1,2	Alzata portafrutta rettangolare 2p. Rectangular fruit holder 2 layers Serveur rectangulaire 2 étages Etagere, rechteckig 2-stufig Frutero rectangular 2 pisos	cm. 47 x 34 cm. 56 x 40 H cm. 44	18 1/2" x 13 3/8" 22" x 15 3/4" H 17 3/8"
---------	---	--	---

813



mm. 1,2	Sottopiatto quadro Square charger Assiette de bienvenue carrée Platzteller, viereckig Bajo plato cuadrado	cm. 32 x 32	12 5/8" x 12 5/8"
---------	---	-------------	-------------------

814



mm. 1,2	Sottopiatto Charger Assiette de bienvenue Platzteller Bajo plato	Ø cm. 32	Ø 12 5/8"
---------	--	----------	-----------

838



mm. 1,2	Sottobicchiere Glass coaster Dessous de verre Glasuntersatz Posavasos	cm. 10 x 10	4" x 4"
---------	---	-------------	---------

839



mm. 1,2	Sottobottiglia Bottle coaster Dessous de bouteille Flaschenteller Posabotella	cm. 14 x 14	5 1/2" x 5 1/2"
---------	---	-------------	-----------------

833

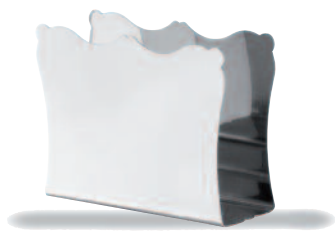

mm. 1,0	Portatovaglioli Napkin holder Distributeur de serviettes Serviettenhalter Portaservilletas	cm. 12,5 x 4 H cm. 9	5" x 1 5/8" H 3 1/2"
---------	--	-------------------------	-------------------------

846



mm. 1,0	Vasetto portafiori Flower vase Soliflore Blumenvase Florero	H cm. 14	H 5 1/2"
---------	---	----------	----------

81601



mm. 3,0	Allacciatovaglioli Napkins ring Rond de serviettes Serviettenring Servilletero	Ø cm 9	Ø 3 1/2"
---------	--	--------	----------

81602



mm. 3,0	Allacciatovaglioli Napkins ring Rond de serviettes Serviettenring Servilletero	Ø cm 9	Ø 3 1/2"
---------	--	--------	----------

81603



mm. 3,0	Allacciatovaglioli Napkins ring Rond de serviettes Serviettenring Servilletero	cm 9 x 8	3 1/2" x 3 1/7"
---------	--	----------	-----------------

81604



mm. 3,0	Allacciatovaglioli Napkins ring Rond de serviettes Serviettenring Servilletero	cm. 8 x 8	3 1/7" x 3 1/7"
---------	--	-----------	-----------------

81605



mm. 3,0	Allacciatovaglioli Napkins ring Rond de serviettes Serviettenring Servilletero	cm. 8 x 8	3 1/7" x 3 1/7"
---------	--	-----------	-----------------

81606



mm. 3,0	Allacciatovaglioli Napkins ring Rond de serviettes Serviettenring Servilletero	cm. 10 x 7	4" x 2 5/8"
---------	--	------------	-------------

812



mm. 1,2	Formaggera Parmesan cheese basin Fromagère Käsedose Quesera Azucarero	Ø cm. 14 cl. 20	Ø 5 1/2" oz. 6 3/4
---------	---	--------------------	-----------------------

811



mm. 1,2	Completo oliera con spargisale Cruet and salt cellar set Service huile-vinaigre 4pcs. Essig-/Ölgestell 4-Tlg. Convoy vinagreras con saleros 4 pzas.	Ø cm. 21 H cm. 19,6 cl. 76	Ø 8 1/4" H 7 3/4" oz. 25 3/4
---------	--	----------------------------------	------------------------------------

825



mm. 1,2	Lasagnera rettangolare Set for Lasagne Service à lasagnes Set mit Porzellanschale, rechteckig Servicio para Lasagne	cm. 48 x 36 lt. 3	18 7/8" x 14 1/8" oz. 102 4/5
---------	--	----------------------	----------------------------------

817



mm. 1,2	Antipastiera Hors d'oeuvre tray Plat à hors-d'oeuvre Vorspeisenplatte Entremesera	cm. 40 x 40	15 3/4" x 15 3/4"
---------	---	-------------	-------------------

854



mm. 1,2	Portachiavi Key holder Porte-clés Schlüsselanhänger Portallaves	cm. 8 x 8	3 1/8" x 3 1/8"
---------	---	-----------	-----------------

837



mm. 1,2	Portaspezie Aromatic condiments set Service pour aromatiques condiments Gewürzständer Servicio para aromaticos y condimentos	cm. 15 x 15 H cm. 25,5 cl. 11 (x 8)	5 7/8" x 5 7/8" H 10" oz. 3 3/4 (x 8)
---------	--	---	---

851



mm. 1,2	Alzata per pesce crudo Elevated rect.seafood presentation Serveur à rafraîchir le poisson Etagerie für marinierte Fisch Porta pescado	cm. 56 x 40 H cm. 18 lt. 4,0	22" x 15 3/4" H 7 1/8" gal. 1
---------	---	------------------------------------	-------------------------------------

852



mm. 1,2	Vassoio rotondo Round tray Plateau rond Tablett rund Bandeja redonda	Ø cm. 21	Ø 8 1/4"
---------	--	----------	----------

819

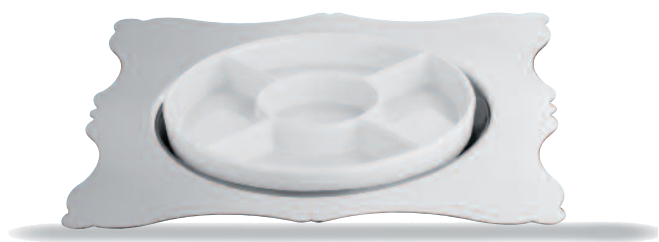

mm. 1,2	Antipastiera 5 scomparti in porcellana China hors-d'oeuvre tray 5 compt. Service à Hors d'oeuvres Set Vorspeisenplatte aus Porzellan 5 Eins. Entremesera en porcelana 5 comp.	cm. 40 x 40	15 3/4" x 15 3/4"
---------	---	-------------	-------------------

820



mm. 1,2	Risottiera Set for risotti Service à Risotto Set mit Porzellanschale, rund Servicio para arroces	cm. 40 x 40 cl. 200	15 3/4" x 15 3/4" oz. 67 3/5
---------	--	------------------------	---------------------------------

836



mm. 1,2	Portabicchieri di carta Paper cup holder Porte-gobelets de papier Papierbecherständer Portavasos de papel	cm. 23 x 12,5 H cm. 22,5	8 7/8" x 4 7/8" H 8 7/8"
---------	---	-----------------------------	-----------------------------

831



mm. 1,2	Portacondimenti con astina Basket for aromatic condiments Support pour Condiments et Aromates Essig-/Ölflaschenhalter Cestos para aromaticos y condimentos	cm. 15 x 15 H cm. 33	5 7/8" x 5 7/8" H 13"
---------	--	-------------------------	--------------------------

853

853



mm. 3,0

Segnaposto
Table number stand
Numéro de table
Tischnummern-Ständer
Numero de mesa

Ø cm. 9
H cm. 9

Ø 3 1/2"
H 3 1/2"

cm. 10 x 7
H cm. 7

4 x 2 3/4"
H 2 3/4"

cm. 8 x 8
H cm. 8

3 1/8" x 3 1/8"
H 3 1/8"

7061

7064



7061

7062

7063

7064

Candelabro bugia
Candlestick
Chandelier
Leuchter
Candelabro

H cm. 13
H 5 1/8"

Candelabro a 1 fiamma
Candlestick
Chandelier
Leuchter 1 Flam.
Candelabro

H cm. 23,6
H 9 1/4"

Candelabro a 3 fiamme
Candelabra, 3 arms
Chandelier 3 flammes
Leuchter 3 Flammig
Candelabro 3 luces

H cm. 23,6
H 9 1/4"

Candelabro a 5 fiamme
Candelabra, 5 arms
Chandelier 5 flammes
Leuchter 5 Flammig
Candelabro 5 luces

H cm. 23,6
H 9 1/4"

866

NEW



mm. 3,0

Segnaposto
Table number stand
Numéro de table
Tischnummern-Ständer
Numero de mesa

Ø cm. 3,5

Ø 1 1/3"

411



mm. 1,2
Caffetteria
Coffee pot
Cafetière
Kaffeekanne
Cafetera

Tazze	2	cl. 25	8 1/2 oz.
Cups	4	cl. 37	12 1/2 oz.
Bols	6	cl. 52	17 5/8 oz.
Tassen	8	cl. 70	23 5/8 oz.
Tazas	10	cl. 100	33 7/8 oz.
	12	cl. 150	50 3/4 oz.
	16	cl. 200	67 5/8 oz.

412



mm. 1,2
Teiera
Tea pot
Théière
Teekanne
Tetera

Tazze	4	cl. 55	18 5/8 oz.
Cups	6	cl. 70	23 5/8 oz.
Bols	8	cl. 97	32 3/4 oz.
Tassen			
Tazas			

413



mm. 1,2
Lattiera
Milk jug
Pot à lait
Milchkanne
Jarra lechera

Tazze	1	cl. 10	3 3/8 oz.
Cups	2	cl. 25	8 1/2 oz.
Bols	4	cl. 37	12 1/2 oz.
Tassen	6	cl. 52	17 5/8 oz.
Tazas	8	cl. 70	23 5/8 oz.
	10	cl. 100	33 7/8 oz.
	12	cl. 150	50 3/4 oz.
	16	cl. 200	67 5/8 oz.

414



mm. 1,2
Zuccheriera
Sugar bowl
Sucrier
Zuckerdose
Azucarero

Tazze	4	cl. 18	6 1/8 oz.
Cups	8	cl. 30	10 1/8 oz.
Bols			
Tassen			
Tazas			



305



mm. 1,2	Vassoio rettangolare	cm. 40,5 x 27,5	15 ⁷ / ₈ " x 10 ³ / ₄ "
	Rectangular tray	cm. 45 x 31	17 ³ / ₄ " x 12 ¹ / ₄ "
	Plateau rectangulaire		
	Tablett, rechteckig		
	Bandeja rectangular		

315



mm. 1,2	Sottobicchiere e sottobottiglia	cm. 10 x 10	4" x 4"
		cm. 12,5 x 12,5	5" x 5"
	Glass and bottle coaster		
	Dessous de verre et de bouteille		
	Glasuntersatz - Flaschenteller		
	Posavasos y Posabotella		

323



mm. 1,2	Sottopiatto quadrato	cm. 32 x 32	12 ¹ / ₂ " x 12 ¹ / ₂ "
	Square charger		
	Assiette de bienvenue carré		
	Platzteller, viereckig		
	Bajo plato cuadrado		

313



mm. 0,8	Sottopiatto	Ø cm. 31	Ø 12 1/4"
	Charger		
	Assiette de bienvenue		
	Platzteller		
	Bajo plato		

319



mm. 1,2	Vassoio quadrato	cm. 32 x 32	12 ¹ / ₂ " x 12 ¹ / ₂ "
	Square plate		
	Plateau carré		
	Tablett, viereckig		
	Bandeja cuadrada		

320



mm. 1,2	Vassoio "Tête à tête"	Ø cm. 22	Ø 8 5/8"
	"Tête à tête" tray		
	Plateau "Tête à tête"		
	Tablett "Tête à tête"		
	Bandeja "Tête à tête"		

312



mm. 1,2 | Antipastiera 4 scomparti in cristallo
Hors-d'oeuvre tray 4 compt.
Plat à hors-d'oeuvre 4 comp. cristal
Vorspeisenplatte 4 Einsatze
Entremesera

cm. 40,5 x 27,5 | 15⁷/₈" x 10³/₄"

327



mm. 1,2 | Antipastiera 5 scomparti in porcellana
China hors-d'oeuvre tray 5 compt.
Plat à hors-d'oeuvre en porcelaine
Vorspeisenplatte aus Porzellan 5 Eins.
Entremesera en porcelana 5 comp.

Ø cm. 31 | Ø 12 1/4"

325



mm. 1,2 | Lasagnera rettangolare
Set for Lasagne
Service pour Lasagne
Set mit Porzellanschale, rech.
Servicio para Lasagne

cm. 40,5 x 27,5 | 15⁷/₈" x 10³/₄"
lt. 3 | oz. 102 1/9

324



mm. 1,2 | Risottiera tonda
Set for risotti
Service pour risotto
Set mit Porzellanschale, rund
Servicio para arroces

Ø cm. 31 | Ø 12 1/4"
lt. 2 | oz. 67 3/5

309



mm. 1,2 | Portatovaglioli
Napkin holder
Distributeur de serviettes
Serviettenhalter
Portaservilletas

cm. 22 x 22 | 8⁵/₈" x 8⁵/₈"

31802



mm. 1,2 | Portaspezie
Aromatic condiments set
Service pour aromatiques
condiments
Gewürzständer
Servicio para aromaticos y
condimentos

cm. 15 x 15 | 5 7/8" x 5 7/8"
H cm. 25,5 | H 10"
cl. 11 (x 8) | oz. 3 3/4 (x 8)

308



mm. 1,2	Cestino per pane Basket Corbeille Brotschale Cuenco	cm. 22 x 22 cl. 80	8 ⁵ / ₈ " x 8 ⁵ / ₈ " oz. 27
---------	---	-----------------------	---

317

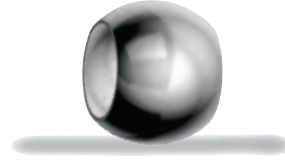

mm. 1,2	Allacciatovaglioli Napkins ring Rond de serviette Serviettenring Servilletero	Ø cm. 6	Ø 2 3/8"
---------	---	---------	----------

306



mm. 1,2	Completo oliera con spargisale Cruet and salt cellar set 4 pcs. Service huile-vinaigre 4 pcs. Essig-/Ölgestell 4-Tlg. Convoy vinagreras con saleros	H cm. 19 cl. 18 (x2) cl. 11 (x2)	H 7 ³ / ₈ " oz. 6 (x2) oz. 3 ³ / ₄ (x2)
---------	---	--	---

307



mm. 1,2	Formaggera Parmesan cheese basin Fromagère Kasedose Quesera-Azucarero	cl. 20	oz. 6 3/4
---------	---	--------	-----------

310



mm. 1,2	Portabicchieri di carta Paper cup holder Porte-gobelets de papier Papierbecherständer Portavasos de papel	cm. 21 x 11 H cm. 22,8	8 ³ / ₁₆ " x 4 ¹ / ₄ " H 8 7/8"
---------	---	---------------------------	--

321



mm. 1,2	Portapiatti di plastica Plastic paper plate dispenser Porte-plateau de plastique Stand für Plastik Platten Portaplatos de plastica	Ø cm. 22	Ø 8 5/8"
---------	--	----------	----------



164



mm. 1,2	Vassoio rettangolare Rectangular tray Plateau rectangulaire Tablett, rechteckig Bandeja rectangular	cm. 40 x 29	15 ³ / ₄ " x 11 ³ / ₈ "
		cm. 49 x 36	19 ¹ / ₄ " x 14 ¹ / ₈ "

165



mm. 1,2	Vassoio rotondo Round tray Plateau ronde Tablett, rund Bandeja redonda	Ø cm. 35	Ø 13 ³ / ₄ "

168



mm. 1,2	Completo olera con spargisale Cruet and salt cellar set 4 pcs Service huile-vinaigre 4 pièces Essig-/Ölgestell 4-Tlg. Convoy vinagreras con saleros 4 piezas	H cm. 20	H 7 ⁷ / ₈ "
		cl. 18 (x 2)	oz. 6 (x 2)
		cl. 11 (x 2)	oz. 3 ³ / ₄ (x 2)

169



mm. 1,2	Formaggera Parmesan cheese basin Fromagère Kasedose Quesera-Azucarero	cl. 20	oz. 6 ³ / ₄

166

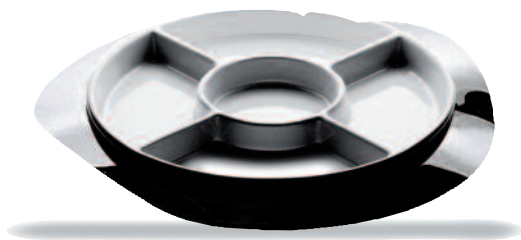

mm. 1,2	Antipastiera 5 scomparti porcell. China hors- d'oeuvre tray 5 compt. Plat à hors-d'oeuvre 5 comp. Vorspeisenplatte 5 Einsätze Entremesera 5 comp.en porcel.	Ø cm. 35	Ø 13 ³ / ₄ "

186



mm. 1,2	Cestino semitraforato Half fretworked basket Corbeille demi-ajouré Früchekorb, halbgelocht Frutero semiperforado	Ø cm. 24	Ø 9 ¹ / ₂ "

408



mm. 1,2	TALAMO Vassoio rettangolare Rectangular tray Plateau rectangulaire Tablett, rechteckig Bandeja rectangular	cm. 29 x 23	11 ³ / ₈ " x 9"
		cm. 47 x 37	18 ¹ / ₂ " x 14 ¹ / ₂ "

409



mm. 1,2	TALAMINO Vassoio quadrato Square tray Plateau carré Tablett, viereckig Bandeja cuadrada	cm. 37 x 37	14 ¹ / ₂ " x 14 ¹ / ₂ "

406

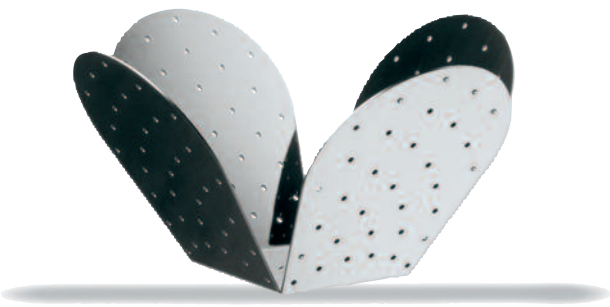

mm. 1,2	BOCCIOLIO Cestino Basket Corbeille Obstschale Frutero	Ø cm. 24,5	Ø 9 2/3"
		H cm. 13,5 lt. 4	H 5 1/3" gal. 1

407

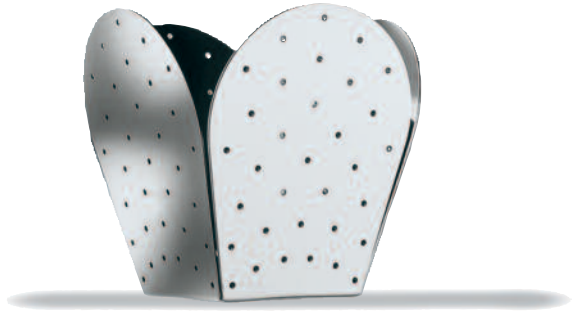

mm. 1,2	BOCCIOLINO Cestino Basket Corbeille Obstschale Frutero	Ø cm. 16,5	Ø 6 1/2"
		H cm. 15,5 lt. 2,64	H 6 1/9" oz. 89 1/4

410



mm. 1,2	COROLLA Completo oliera con spargisale Cruet and salt cellar set Service huile-vinaigre Essig-/Ölgestell 4-Tlg. Convoy vinagreras con saleros H cm. 20- cl.18(x2) cl.11(x2) H 7 ⁷ / ₈ " - oz.6(x2) oz.3 ³ / ₄ (x2)	PISTILLA Formaggera Parmesan cheese basin Fromagère Käsedose Quesera-Azucarero cl. 20 oz. 6 ³ / ₄

505



mm. 1,2	COROLLA Cestello portacondimenti Basket for aromatic condiments Corbeille pour aromatiques condiments Essig-und Öl Flaschenhalter Cesto para aromaticos y condimentos	H cm. 20	H 7 ⁷ / ₈ "
		cl.25(x2) cl.11(x2)	oz.8 ¹ / ₂ (x2) oz.3 ³ / ₄ (x2)

331



mm. 1,2 | Sottopiatto
Charger
Assiette de bienvenue
Platzteller
Bajo plato | Ø cm. 33 | Ø 13"

333

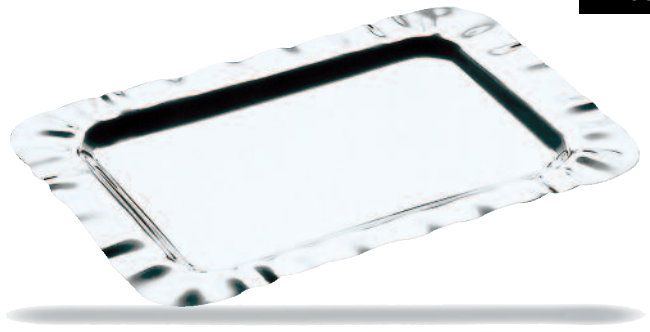

mm. 1,2 | Vassoio rettangolare
Rectangular tray
Plateau rectangulaire
Tablett, rechteckig
Bandeja rectangular | cm. 50 x 34 | 19⁵/₈" x 13³/₈"

332



mm. 1,2 | Vassoio ovale
Oval tray
Plateau oval
Tablett, oval
Bandeja oval | cm. 49 x 33 | 19¹/₄" x 13"

337



mm. 1,2 | Cestino tondo
Round basket
Corbeille ronde
Obstschale, rund
Frutero redondo | Ø cm. 31 | Ø 12¹/₄"
cl. 125 | oz. 42¹/₄

335



mm. 1,2 | Completo oliera con spargisale
Cruet and salt cellar set
Service huile-vinaigre
Essig-/Ölgestell 4-Tlg.
Convoy vinagreras con saleros
H cm. 21- cl.22,5(x2) cl.7,5(x2)
H 8¹/₄" - oz.7¹/₂(x2) oz.2¹/₂ (x2)

336



Formaggera
Parmesan cheese basin
Fromagère
Käsedose
Quesera-Azucarero
cl. 20
oz. 6³/₄

334



mm. 1,2 | Antipastiera 5 scomparti cristallo
Hors d'oeuvre tray 5 compt.
Plat à hors-d'oeuvre 5 comp. cristal
Vorspeisenplatte 5 Einsätze
Entremesera 5 cristales | Ø cm. 33 | Ø 13"

201



mm. 1,2	Vassoio	cm. 30 x 24	11 ³ / ₄ " x 9 ¹ / ₂ "
	Tray	cm. 40 x 31	15 ³ / ₄ " x 12 ¹ / ₄ "
	Plateau Tablett Bandeja	cm. 50 x 39	19 ⁵ / ₈ " x 15 ³ / ₈ "

202



mm. 1,2	Vassoio con maniglie	cm. 40 x 31	15 ³ / ₄ " x 12 ¹ / ₄ "
	Tray with handles	cm. 50 x 39	19 ⁵ / ₈ " x 15 ³ / ₈ "
	Plateau avec anses Tablett mit Griffen Bandeja con asas		

203



mm. 1,2	Vassoio	Ø cm. 25	Ø 9 ⁷ / ₈ "
	Tray	Ø cm. 31	Ø 12 ¹ / ₄ "
	Plateau Tablett Bandeja		

199

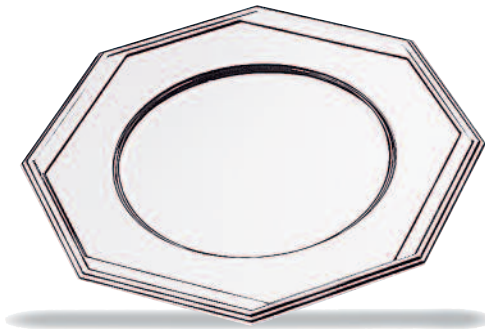

mm. 1,2	Sottopiatto	Ø cm. 31	Ø 12 ¹ / ₄ "
	Charger		
	Assiette de bienvenue Platzteller Bajo plato		

716



mm. 0,8	Plattino per burro con coperchio e griglia	Ø cm. 9	Ø 3 ¹ / ₂ "
	Butter dish with inserted grill and cover	cl. 25	oz 8 ¹ / ₂
	Beurrer avec grill et couvercle Butterkühler mit Einsatzsieb und Deckel Plato para mantequilla con rejilla y tapa		

210

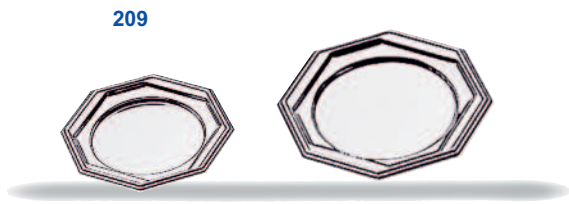

mm. 0,8	Sottobicchiere e sottobottiglia	Ø cm. 10,5	Ø 4 ¹ / ₈ "
	Glass and bottle coaster	Ø cm. 12,5	Ø 4 ⁷ / ₈ "
	Dessous de verre et de bouteille Glasuntersatz - Flaschenteller Posavaso y Posabotella		

502



mm. 0,8 | Completo oliera con spargisale
Cruet and salt cellar set
Service huile-vinaigre 4 pièces
Essig-/Ölgestell 4-Tlg.
Convoy vinagreras con saleros 4 pzs

H cm. 21 | H 8 1/4"
cl. 22,5 (x 2) | oz. 7 1/2 (x 2)
cl. 7,5 (x 2) | oz. 2 1/2 (x 2)

522



mm. 0,8 | Formaggera
Parmesan cheese basin
Fromagère
Käsedose
Quesera-Azucarero

cl. 20 | oz. 6 3/4

207/5



mm. 1,2 | Antipastiera 5 scomparti in porcellana
China hors d'oeuvre tray 5 compt.
Plat à hors-d'oeuvre 5 comp. en porc.
Vorspeisenplatte 5 Einsätze
Entremesera 5 comp.en porcelana

Ø cm. 31 | Ø 12 1/4"

848



mm. 1,2 | Portabon bon con coperchio
Round candy bowl with lid
Legumière avec couvercle
Bonbonsschale mit Deckel
Portacaramelos con tapa

Ø cm. 25 | Ø 9 7/8"
cl. 150 | oz. 50 3/4

844

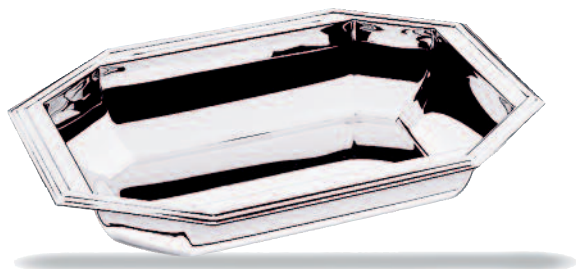

mm. 1,2 | Cestino rettangolare
Rectangular basket
Corbeille rectangulaire
Obstschale rechteckig
Panera rectangular

cm. 30 x 24 | 11 3/4" x 9 1/2"
cl. 200 | oz. 67 5/8

843



mm. 1,2 | Cestino
Round Basket
Corbeille
Obstschale
Frutero

Ø cm. 25 | Ø 9 7/8"
cl. 150 | oz. 50 3/4
Ø cm. 31 | Ø 12 1/4"
cl. 250 | oz. 84 1/2

103



mm. 1,2	Sottopiatto	Ø cm. 33	Ø 13"
	Charger	Ø cm. 35	Ø 13 3/4"
Assiette de bienvenue			
Platzteller			
Bajo plato			

292



mm. 1,2	Servizio per zucchero con cristallo	Ø cm. 33	Ø 13"
	Sugar set with crystal	cl. 15(x3)	oz. 5(x3)
Service à sucre avec cristal			
Zuckerständer mit Kristalleinsätzen			
Servicio para azúcar con cristales			

294



mm. 1,2	Porta pasticcini con piedistallo	Ø cm. 19	Ø 7 1/2"
	Petit-fours stand with base	H cm. 14,5	H 5 3/4"
Porte-petits-fours avec socle			
Petit Fours-Ständer			
Porta dulces con pedestal			
		Ø cm. 24	Ø 9 1/2"
		H cm. 14,5	H 5 3/4"

7003/A



mm. 1,2	Alzata portafrutta 2 piani	Ø cm. 24	Ø 9 1/2"
	Fruit holder 2 layers	Ø cm. 31	Ø 12 1/4"
Serviteur 2 etages			
Etagere 2 stufig			
Frutero 2 pisos			
		H cm. 24,5	H 9 5/8"

293



mm. 1,2	Porta pasticcini con piedistallo 2 Piani	Ø cm. 12	Ø 4 3/4"
	Petit-fours stand with base 2 Layers	Ø cm. 19	Ø 7 1/2"
Porte-petits-fours avec socle 2 Etages			
Mokkaetagerer 2 Ebenen			
Porta dulces con pedestal 2 Pisos			
		H cm. 27	H 10 5/8"

7003/B



mm. 1,2	Alzata portafrutta 3 piani	Ø cm. 19	Ø 7 1/2"
	Fruit holder 3 layers	Ø cm. 24	Ø 9 1/2"
Serviteur 3 etages			
Etagere 3 stufig			
Frutero 3 pisos			
		Ø cm. 31	Ø 12 1/4"
		H cm. 35,5	H 14"

849



mm. 1,2	Cestino per frutta secca con rompinoci Bowl with nut crackers Corbeille à fruit secs avec casse-noix Nusschale mit Nussknacher Frutero con rompenueces	Ø cm. 20 cl. 150	Ø 7 7/8" oz. 50 3/4
---------	--	---------------------	------------------------

715



mm. 0,8	Piattino per burro con coperchio e griglia Butter dish with inserted grill and cover Beurrier avec grille et couvercle Butterdose mit Einsatzsieb und Deckel Plato para mantequilla con rejilla y tapa	Ø cm. 9 cl. 20	Ø 3 1/2" oz. 6 3/4
---------	--	-------------------	-----------------------

105



mm. 1,2	Sottobicchiere Glass coaster Dessous de verre Glasuntersatz Posavaso	Ø cm. 10	Ø 4"
---------	--	----------	------

106



mm. 1,2	Sottobottiglia Bottle coaster Dessous de bouteille Flaschenteller Posabotella	Ø cm. 12	Ø 4 3/4"
---------	---	----------	----------

208

NEW



mm. 1,2	Piattino per pane Bread tray Plat pour pan Brot Platte Plato para pan	Ø cm. 14	Ø 5 1/2"
---------	---	----------	----------

204



mm. 1,2	Porta macaron Macarons server Porte macarons Macaronsträger Porta macaron	Ø cm. 15 H cm. 11,5 cl. 20	Ø 5 7/8" H 4 1/2" oz. 6 3/4
---------	---	----------------------------------	-----------------------------------

497



mm. 1,2 Completo oliera con spargisale 5 pz.
Cruet and salt cellar set 5 pcs
Service huile-vinaigre 5 pièces
Essig-Ölgestell 5-Tlg.
Vinagreras 5 pza

H.cm.21
cl. 30 (x2)
cl. 8 (x3)

H. 8 1/4"
oz. 10 1/8 (x2)
oz. 2 3/4 (x3)

509



mm. 1,2 Completo oliera con spargisale 4 pz.
Cruet and salt cellar set 4 pcs
Service huile-vinaigre 4 pièces
Essig-Ölgestell 4-Tlg.
Vinagreras 4 pza

H.cm.21
cl. 30 (x2)
cl. 8 (x2)

H. 8 1/4"
oz. 10 1/8 (x2)
oz. 2 3/4 (x2)

508



mm. 1,2 Oliera
Cruet
2 pièces huile-vinaigre
Essig-Ölgestell 2 Tlg.
Vinagreras 2 pza

H.cm.21
cl. 30 (x2)

H. 8 1/4"
oz. 10 1/8 (x2)

510



mm. 1,2 Spargisale portastecchi con base
Salt cellar w/toothpick container w/base
Sel, poivre, porte cure-dents a/socle
Salz-Pfeffer-Zahnstocherbehälter 3-tlg.
Sal & Pimenta & palillero 3 pza

H. cm.14
cl. 8 (x3)

H. 5 1/2"
oz. 2 3/4 (x3)

350



Cristallo per spargisale art. 510
Salt and pepper container for art. 510
Cristal pour art. 510
Ersatzglass für Art. 510
Cristal por saleros art. 510
cl. 8
oz. 2 3/4

Ampolla
Cruet
Huilliere
Öl-/Essigflasche
Vinagrera
H cm. 18 - cl. 30
H 7 1/8" - oz. 10 1/8

510ST



Portastecchi senza base
Toothpick container w/out base
Porte cure-dents sans/socle
Zahnstocherbehälter ohne Fuß
Palillero sin pedestal

cl. 8

oz. 2 3/4

611



mm. 1,2 | Formaggera
Parmesan cheese basin
Fromagère
Käsedose
Quesera - Azucarero | cl. 20 | oz. 6 3/4

512



430491SS

Cristallo per spargisale art. 512-602
Crystal glass container for art. 512-602
Cristal avec capsule pour art. 512-602
Erzatzglass mit Kapsel für art. 512-602
Cristal por saleros art. 512-602
cl. 11 - oz. 3 3/4

mm. 1,2 | Spargisale-portastecchi
Salt cellar with toothpick container
Sel + poivre + cure dents
Salz-Pfeffer-Zahnstocherbehälter
Saleros y pimenteros y pallero
H. cm. 14 - cl. 11(x2)
H. 5 1/2" - oz. 3 3/4 (x2)

602

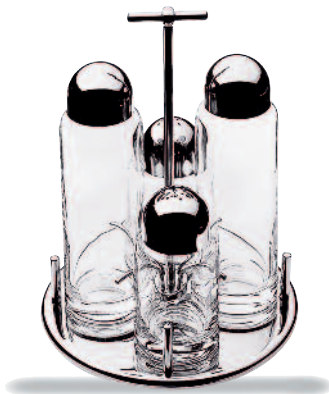

mm. 1,2 | Completo olera con spargisale
Cruet and salt cellar set
Service huile-vinaigre 4 pièces
Essig-Ölgestell 4-tlg.
Convoy vinagreras con saleros | H. cm 19
cl. 18(x2)
cl. 11(x2) | H. 7 1/2"
oz. 6(x2)
oz. 3 3/4(x2)

601



430491

mm. 1,2 | Oliera
Cruet
2 pièces huile-vinaigre
Essig-Ölgestell
Vinagreras

H. cm 19
cl. 18(x2) | H. 7 1/2"
oz. 6(x2)

603



430603

mm. 1,2 | Oliera portacondimenti
Cruet for aromatic condiments
Huilière pour aromatiques condiments
Gewürzmenage
Vinagreras para aromaticos
y condimentos | H. cm 14,5
cl. 11(x2) | H. 5 3/4"
oz. 3 3/4(x2)

604



mm 1,2 | Portamarmellata a 3 scomparti
Jam pack holder 3 compt.
Porte-confiture 3 comp.
Marmeladegestell 3 Einsätze
Marmeladero 3 comp.
H. cm. 19 - H. 7 1/2"

304



604

mm. 1,2 | Oliera a 3 pezzi
Cruet 3 pcs
Huilière 3 pcs
Menage 3-Tlg.
Vinagreras 3 pzas
H. cm. 19 -cl.18(x2)-cl. 11
H. 7 1/2" - oz.6(x2) oz.3 3/4



231



mm. 0,8	Piatto ovale da portata bordo rinforzato	cm. 25 x 17	9 7/8" x 6 3/4"
	Oval serving plate with reinforced edges	cm. 30 x 21	11 3/4" x 8 1/4"
	Plat oval de service bord renforcé	cm. 35 x 24	13 3/4" x 9 1/2"
	Bratenplatte oval	cm. 40 x 27	15 3/4" x 10 5/8"
	Fuente ovalada borde reforzado	cm. 45 x 32	17 3/4" x 12 5/8"
		cm. 50 x 35	19 5/8" x 13 3/4"
	cm. 60 x 41	23 5/8" x 16 1/8"	

241



mm. 0,8	Piatto ovale da portata pesce bordo rinforzato	cm. 55 x 24
	Oval serving fish plate with reinforced edges	cm. 70 x 29
	Plat à poisson oval bord renforcé	21 5/8" x 9 1/2"
	Fischplatte, oval	27 1/2" x 11 3/8"
	Fuente pescado borde reforzado	

233



mm. 1,2	Piatto ovale da portata mod. pesante	cm. 30 x 22	11 3/4" x 8 5/8"
	Oval serving plate with reinforced edges heavy mod.	cm. 35 x 26	13 3/4" x 10 1/2"
	Plat oval de service bord renforcé Mod. pesant	cm. 40 x 28	15 3/4" x 11"
	Bratenplatte, oval, schweres Mod.	cm. 45 x 31	17 3/4" x 12 1/4"
	Fuente ovalada nuevo modelo	cm. 50 x 34	19 5/8" x 13 3/8"

243



mm. 1,2	Piatto ovale da portata pesce mod. pesante	cm. 55 x 25
	Oval serving fish plate heavy weight	cm. 70 x 27
	Plat à poisson modèle Pesant	21 5/8" x 9 7/8"
	Fischplatte, oval, schweres Mod.	27 1/2" x 10 5/8"
	Fuente ovalada pescado nuevo modelo	

251



mm. 0,8	Piatto rotondo da portata bordo rinforzato	Ø cm. 27	Ø 10 5/8"
	Round serving plate with reinforced edges	Ø cm. 30	Ø 11 3/4"
	Plat rond de service bord renforcé	Ø cm. 35	Ø 13 3/4"
	Bratenplatte, rund	Ø cm. 40	Ø 15 3/4"
	Bandeja redonda borde reforzado		

269



mm. 0,8	Copripiatto sovrapponibile	GALA	Ø cm.28	Ø 11"
	Stackable cover for round plate	»		
	Couvre-plat	»		
	Stapelbarer Teller cloche	»		
	Cubre platos	»		

263



mm. 0,8 | Piatto tondo per legumi a 3 sc. | Ø cm. 27 | Ø 10 5/8"
 3 sections vegetable dish
 Plat à légumes rond - 3 compt.
 Teller rund 3 Abteilungen
 Bandeja para legumbres 3 comp.

264



mm. 0,8 | Coperchio per piatto tondo art. 263 | Ø cm. 25 | Ø 9 7/8"
 Lid for art. 263
 Couvercle pour plat rond art. 263
 Deckel für Teller 3 Abtlg.
 Tapa para bandeja redonda art. 263

266



mm. 0,8 | Piatto ovale per legumi a 2 sc. | cm. 30 x 21 | 11 3/4" x 8 1/4"
 2 section vegetable dish
 Plat à légumes oval - 2 comp.
 Teller oval, 2 Abteilungen
 Bandeja para legumbres 2 comp.

267



mm. 0,8 | Coperchio per piatto ovale art. 266 | cm. 27 x 18 | 10 5/8" x 7 1/8"
 Lid for art. 266
 Couvercle pour plat oval art. 266
 Deckel für Teller, 2 Abtlg.
 Tapa para bandeja ovalada art. 266

235



mm. 1,2 | Vassoio per gratin | cm. 35 x 20 | 13 3/4" x 7 1/8"
 Tray for "gratin" | cm. 40 x 24 | 15 3/4" x 9 1/2"
 Plat à "gratin"
 Gratinplatte
 Bandeja gratinar
 15 3/4" x 9 1/2"

236



mm. 0,8 | Coperchio per Art. 235 | cm. 35 x 20 | 13 3/4" x 7 1/8"
 Lid for Art. 235 | cm. 40 x 24 | 15 3/4" x 9 1/2"
 Couvercle pour Art. 235
 Deckel für Art. 235
 Tapa para Art. 235

253



mm. 0,8	Cloche per piatto rotondo	Ø cm. 27	Ø 10 5/8"
	Cloche for round plate	Ø cm. 35	Ø 13 3/4"
	Cloche pour plat rond	Ø cm. 40	Ø 15 3/4"
	Tellercloche für Bratenplatte rund		
	Tapa para fuente redonda		

245



mm. 0,8	Cloche per piatto ovale	cm. 30	11 3/4"
	Cloche for oval plate	cm. 35	13 3/4"
	Cloche pour plat oval de service	cm. 40	15 3/4"
	Tellercloche für Bratenplatte oval	cm. 45	17 3/4"
	Tapa para fuente ovalada	cm. 50	19 5/8"

211



mm. 0,6	Vassoio rettangolare per pasticceria	cm. 26 x 19	10 1/4" x 7 1/2"
		cm. 31 x 21	12 1/4" x 8 1/4"
	Rectangular tray for cakes		
	Plat à tarte rectangulaire		
	Gebäckplatte, rechteckig		
	Bandeja		

238



mm. 1,2	Vassoio per gratin e gastronomia	cm. 25 x 18	9 7/8" x 7 1/8"
		cm. 30 x 22	11 3/4" x 8 5/8"
		cm. 35 x 25	13 3/4" x 9 7/8"
		cm. 40 x 29	15 3/4" x 11 3/8"
		cm. 45 x 31	17 3/4" x 12 1/4"
	Tray for "Gratin-gastronomy"		
	Plat à "Gratin et gastronomie"		
	Gratinplatte für Gastronomie		
	Bandeja para gratinar y gastronomia		

247



mm. 0,8	Cloche con pomolo per sottopiatto	Ø cm. 10,5	Ø 4 1/16"		
		Ø cm. 13	Ø 5 1/16"		
		Ø cm. 20	Ø 7 7/8"		
		Ø cm. 22	Ø 8 5/8"		
		Ø cm. 24	Ø 9 1/2"		
		Ø cm. 26	Ø 10 1/4"		
		Ø cm. 28	Ø 11"		
		Ø cm. 31	Ø 12 1/8"		
		Ø cm. 32	Ø 12 5/8"		
			Cloche with knob for under plate		
			Cloche pour sous-assiette		
	Tellercloche				
	Tapa para fuente redonda				

268



mm. 0,8	Copripiatto sovrapponibile	Ø cm. 20	Ø 7 7/8"		
		Ø cm. 24	Ø 9 1/2"		
		Ø cm. 26	Ø 10 1/4"		
		Ø cm. 27	Ø 10 5/8"		
		Ø cm. 28	Ø 11"		
		Ø cm. 30	Ø 11 3/4"		
		Ø cm. 31	Ø 12 3/8"		
		Ø cm. 33	Ø 13"		
			Stackable cover for round plate		
			Couvre-plat		
	Stapelbarer Tellercloche				
	Cubre platos				



272



mm. 0,8
 Piatto termico con copripiatto e ciambella termica
 Insulated plate with cover and thermal serving unit
 Plat thermique avec couvre-plat et disque thermique
 Warmhalteteller mit Tellerlocke und Thermikelement
 Plato térmico con cubre platos y bobina térmica

Ø cm. 28,5
 Ø cm. 30,5
 Ø cm. 33,7

Ø 11 1/4"
 Ø 12"
 Ø 13 1/4"

273



mm. 0,8
 Piatto termico con cloche e ciambella termica
 Insulated plate with cloche and thermal serving unit
 Plat thermique avec cloche et disque thermique
 Warmhalteteller mit Tellerlocke und Thermikelement
 Plato térmico con tapadera y bobina térmica

Ø cm. 28,5
 Ø cm. 30,5
 Ø cm. 33,7

Ø 11 1/4"
 Ø 12"
 Ø 13 1/4"

A Ø cm. 28 - 30
 Ø 11" - 11 3/4"

B Ø cm. 28 - 30
 Ø 11" - 11 3/4"

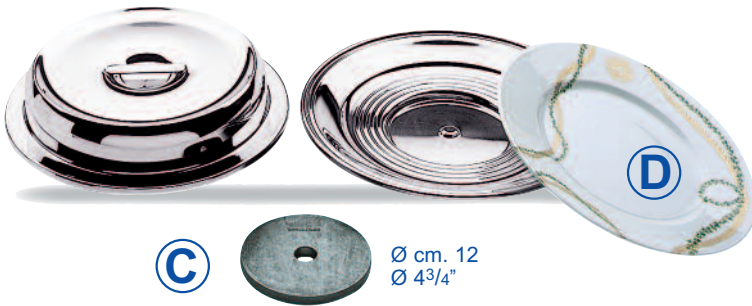

C Ø cm. 12
 Ø 4 3/4"

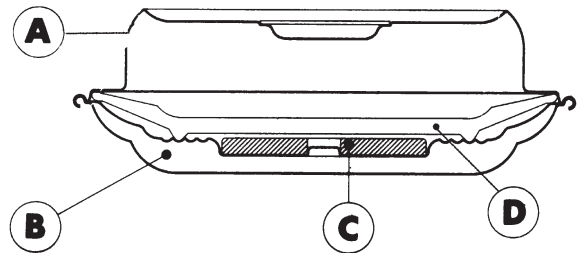

La ciambella termica © è usata per mantenere a lungo le temperature calde o fredde.

Nel primo caso va riscaldata in forno ad una temperatura variabile tra i 60°C ed i 150°C; nel secondo caso in Freezer a -14°C. In queste condizioni è in grado di mantenere la temperatura desiderata (da -5°C a +50°C) per un periodo che varia dai 20 ai 30 minuti.

The Thermal serving unit © maintains food at hot or cold temperatures for about 30 minutes.

The disk can be placed in an oven at 140°C (302°F) or in a freezer at -14°C (-57°F).

Le disque thermique © est utilisé pour maintenir la chaleur ou le froid. Dans un cas, le disque est préchauffé dans le four à une température variant de 60°C à 150°C. Dans un second cas, le disque peut être refroidi jusqu'à -14°C. Dans ces conditions, le disque est en mesure de maintenir la chaleur ou la fraîcheur pendant un temps variable de 20 à 30 minutes, à la température voulue (de -5°C à -50°C).

Der Warmhalteteller mit Thermikelement dient zum Servieren von warm- oder kalzuhaltenden Speisen, also sowohl zur Speicherung von Wärme als auch von Kälte. Zum Warmhalten erhitzt man das runde Thermikelement im Ofen auf 60° bis 150° C. Zum Kalthalten kühlt man im Gefrierfach das runde Thermikelement auf -14° C ab. Derart eingefügt in die die Vertiefung des Warmhaltetellers kann man Speisen bis zu 30 min bei einer gewünschten Temperatur zwischen -5° C und +50° C warm halten.

La bobina térmica © puede ser utilizada para mantener el calor o el frío. En el primer caso se calienta en el horno a una temperatura variable entre 60°C y 150°C; en el segundo, se mete en un congelador a -14°C. En estas condiciones es capaz de mantener los alimentos calientes o fríos durante un periodo que oscila entre 20 y 30 minutos a la temperatura deseada (de -5° C a +50° C).

Una rivoluzionaria soluzione per un servizio ai piani di alta classe, nella massima sicurezza anti-incendio, evitando l'uso di fiamme o fornelli.

A revolutionary solution for room service, eliminating the need of fuel or electric wires.

C'est une solution révolutionnaire pour un Service à l'Étage de qualité en conformité avec les règles de sûreté anti-incendie et en évitant l'usage de flammes ou feux ouverts.

Dies ist eine revolutionäre Lösung für den hohen Anspruch an excellenten Zimmerservice. Man vermeidet dabei den Gebrauch von offenem Feuer oder elektrischen Platten und vermeidet Konflikte mit den Brandschutzrichtlinien der jeweiligen Länder

Es una solución revolucionaria para un servicio de habitación de alta calidad que respeta las normas de seguridad contra incendios, pues evita el peligro de l'uso de llamas y hornillos encendidos.

732



mm. 1,2	Zuppiera nuovo modello	Ø cm. 14 - lt. 0,6	Ø 5 1/2" - oz. 20 1/4
	Soup tureen new mod.	Ø cm. 18 - lt. 1,2	Ø 7" - oz. 40 5/8
	Soupière nouveau modele	Ø cm. 20 - lt. 1,8	Ø 7 7/8" - oz. 60 7/8
	Suppenterrine neues Mod.	Ø cm. 22 - lt. 2,5	Ø 8 5/8" - oz. 84 1/2
	Sopera nuevo Modelo	Ø cm. 24 - lt. 3,1	Ø 9 1/2" - oz. 104 7/8
		Ø cm. 26 - lt. 3,9	Ø 10 1/4" - oz. 131 7/8
	Ø cm. 28 - lt. 5,1	Ø 11" - gal. 1 1/4	

782



mm. 1,2	Legumiera nuovo modello	Ø cm. 14 - lt. 0,6	Ø 5 1/2" - oz. 20 1/4
	Vegetable dish new model	Ø cm. 18 - lt. 1,2	Ø 7" - oz. 40 5/8
	Lègumiere nouveau modele	Ø cm. 20 - lt. 1,8	Ø 7 7/8" - oz. 60 7/8
	Lègumier neues Modell	Ø cm. 22 - lt. 2,5	Ø 8 5/8" - oz. 84 1/2
	Legumbrera nuevo Modelo	Ø cm. 24 - lt. 3,1	Ø 9 1/2" - oz. 104 7/8
		Ø cm. 26 - lt. 3,9	Ø 10 1/4" - oz. 131 7/8
	Ø cm. 28 - lt. 5,1	Ø 11" - gal. 1 1/4	

736



mm. 1,2	Coperchio per art. 732 - 782	Ø cm. 14	Ø 5 1/2"
	Lid for art. 732 - 782	Ø cm. 18	Ø 7"
	Couvercle pour art. 732 - 782	Ø cm. 20	Ø 7 7/8"
	Deckel für art. 732 - 782	Ø cm. 22	Ø 8 5/8"
	Tapa para art. 732 - 782	Ø cm. 24	Ø 9 1/2"
		Ø cm. 26	Ø 10 1/4"
	Ø cm. 28	Ø 11"	

701



10131140

mm. 1,2	Salsiera mod. "Aladino"	cl. 10	oz. 3 3/8
	Gravy boat mod. "Aladino"	cl. 15	oz. 5 1/8
	Saucière mod. "Aladino"	cl. 30	oz. 10 1/8
	Sauciere mod. "Aladino"		
	Mestolino per salsa	Lungh. cm. 18,7	Long. 7 3/8"
	Ladle for gravy boat		
	Cuillère à sauce		
	Saucenlöffel		
	Cacillo para salsa		

511



430511SS

mm. 0,8	Completo spargisale-portastecchi Salt-cellar with toothpick container Sel+poivre+porte cure-dents Salz+Pfeffer+Zahnstocherbehälter Saleros y pimentero y palillero	H cm. 14	H 5 1/2"
		cl. 8	oz. 2 3/4

731



mm. 1,2	Zuppiera monoporzione demitasse Soup cup with base Soupiere sur socle avec anses Suppentasse auf Fuss Taza para sopa con pedestal	Ø cm 10	Ø 3 7/8"
		cl. 23	oz. 8
		Ø cm 12	Ø 4 3/4"
		cl. 35	oz. 11 7/8

772



mm. 0,8 | Molla per ghiaccio
Ice tongs
Pince à glaçon
Eiszange
Pinzas hielo
Lungh. cm. 15,5
Length 6 1/8"

778



mm. 2,0 | Molla per ghiaccio
Ice tongs
Pince à glaçon
Eiszange
Pinzas hielo
Lungh. cm. 18
Length 7 1/8"

773



mm. 0,8 | Molla per pane
Bread tongs
Pince à pain
Brotzange
Pinzas pan
Lungh. cm. 18
Length 7 1/8"

774



mm. 0,8 | Molla per dolci
Pastry tongs
Pince à gateaux
Gebäckzange
Pinzas dulces
Lungh. cm. 19
Length 7 1/2"

777



mm. 0,8 | Molla per spaghetti
Spaghetti/Pasta
tongs
Pince à spaghetti
Spaghettizange
Pinzas spaghetti
Lungh. cm. 21
Length 8 1/4"

775

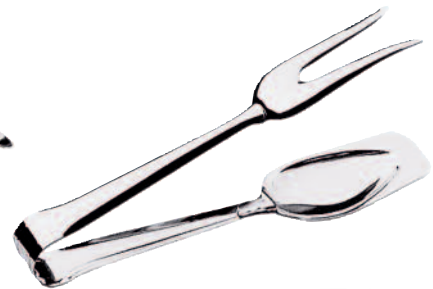

mm. 0,8 | Molla per arrosto e verdure
Roasts and vegetables tongs
Pince à salade et à rôti
Servierzange
Pinzas asado y verduras
Lungh. cm. 21
Length 8 1/4"

779



mm. 0,8 | Molla per lumache
Escargot tongs
Pince à escargots
Schneckenzange
Pinzas para caracoles
Lungh. cm. 16
Length 6 1/4"

771



mm. 0,8 | Molla per zucchero
Sugar tongs
Pince à sucre
Zuckerzange
Pinzas azúcar
Lungh. cm. 14
Length 5 1/2"

752



mm. 0,8	Piattino per lumache	Ø cm. 13,5-6pz.	Ø 5 3/8" - 6pcs.
	Escargot dish	Ø cm. 18 - 12pz.	Ø 7 1/8" - 12pcs
	Molla per lumache	Lungh. cm. 16	Length 6 1/4"
	Tongs for snails		
	Pince à escargots		
	Schneckenzange		
	Pinzas para caracoles		

741



mm. 0,8	Tegamino friggiuova	Ø cm. 16	Ø 6 1/4"
	Frying pan for eggs		
	Plat à oeuf		
	Eierpfanne		
	Plato huevos		

904



mm. 1,2	Posacenere	cm. 14 x 12	5 1/2" x 4 3/4"
	Ash-tray		
	Cendrier		
	Ascher		
	Cenicero		

911



mm. 0,6	Scodella lavadita	Ø cm. 12	Ø 4 3/4"
	Finger bowl	cl. 30	oz. 10 1/8
	Ecuelle		
	Fingerbowl		
	Lavadedos		

956



mm. 1,2	Cloche copriburro o per antipasti	Ø cm. 10,5	Ø 4 1/16"
	Cloche for hors d'oeuvre or butter plate	Ø cm. 13	Ø 5 1/16"
	Cloche dome pour assiette		
	Cloche für Vorspeisen- oder Butterteller		
	Tapa para mantequera o para platos por entremes		

528



mm. 1,2	Formaggera	ODEON	cl. 20	oz. 6 3/4
	Parmesan cheese basin	»		
	Fromagère	»		
	Käsedose	»		
	Quesera-Azucarero	»		

998



Ø mm 8,0 | Portabottiglia
Bottle stand
Porte-bouteille
Rotweinwiege
Portabotella

H cm. 19 | H 7 1/2"

710



711

mm. 0,6 | Portauovo
Egg-cup
Coquetier
Eierbecher
Huevera

cm 15x9 | 5 7/8"x3 1/2"

Ø cm 4,5 | Ø 1 3/4"

707



mm. 1,2 | Portaburro
Butter dish
Beurrier
Butterdose mit Deckel
Mantequera
cm. 11 x 20
4 3/8" x 7 7/8"

720



mm. 1,2 | Portaburro e marmellata
Butter and marmalade dish
Beurrier et confiturier
Butter -Marmaladeplatte
Mantequera y marmeladero
cm. 17,5 x 7,5
6 3/4" x 2 7/8"



mm. 1,2 | Ciotola per antipasto UNO
Snack bowl »
Bol à snacks »
Snackschale »
Cuenco por entremes »
Ø cm 9
Ø 3 1/2"

544

504



504

Ø mm. 6,0 | Cestelli portacondimenti da tavola
Basket for aromatic condiments
Corbeilles pour condiments aromatiques
Tisch-Essig/Öl Flaschenhalter
Cestos para aromaticos y condimentos



503



354

mm. 1,2 | Cestelli portacondimenti da buffet
Basket for aromatic condiments
Corbeilles pour condiments aromatiques
Buffet-Essig/Öl Flaschenhalter
Cestos para aromaticos y condimentos



355

355

446

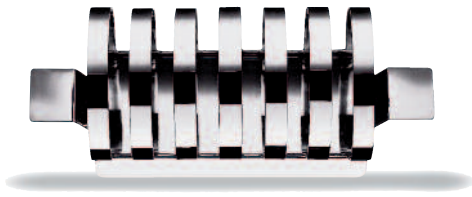

mm. 1,2 | 8 1/2
 Portatoast
 Toast rack
 Porte-toast
 Toastständer
 Portatostadas

cm. 21 x 7,5 | 8 1/4" x 3"

671



mm. 1,0 | Vasetto portafiori
 Flower vase
 Vase à fleur
 Blumenvase
 Florero

H. cm. 14 | H. 5 1/2"

903



mm. 0,6 | Segnaposto
 Table number stand
 Numéro de table
 Tischnummern-Aufsteller
 Numero de mesa

cm 11 x 9
 4 3/8" x 3 1/2"

996

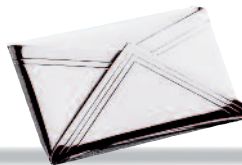

mm. 0,6 | Portanumero
 Table number stand
 Numéro de table
 Tischnummern-Ständer
 Numero de mesa

cm. 9,5 x 5
 3 3/4" x 2"



Ø cm.10
 H cm 10
 Ø 4"
 H 4"

901

289



mm.1,2
 Porta cono patatine
 Chips cone holder
 Porte pommes frites
 Eis-Kartoffenbehälter
 Porta cono patatas fritas

GALA
 "
 "
 "
 "

Ø cm.6 - H cm. 10
 Ø 2" - H 3 7/8"



726
 mm.1,2
 Coppa Martini
 Martini Glass
 Verre à Martini
 Martini glas
 Vaso para Martini
 cl. 11 - cl. 20
 oz. 3 3/4 - oz. 6 3/4

727



727
 mm.1,2
 Coppa per intermezzo
 Intermezzo cup
 Coupe à intermezzo
 Sorbetschale
 Copa para intermezzo
 cl. 4
 oz. 1 3/8

314



mm. 1,2	Vassoio concavo ERGONOMICA	cm 40 x 19	15 ³ / ₄ " x 7 ¹ / ₂ "
	Crescent tray »	cm 55 x 28	21 ⁵ / ₈ " x 11"
	Plateau concave »		
	Konkave Tablett »		
	Bandeja concavo »		

131



mm. 0,8	Sottopiatto RAFFAELLO	Ø cm. 32,5	Ø 12 ³ / ₄ "
	Charger »		
	Assiette de bienvenue »		
	Platzteller »		
	Bajo plato »		

232



mm. 1,2	Vassoio per self service	cm. 40 x 30	15 ³ / ₄ " x 11 ⁷ / ₈ "
	Cafeteria tray		
	Plateau pour self service		
	Tablett fur self service		
	Bandeja para self service		

448



mm. 1,2	PRATER	cm. 20 x 18	7 ⁷ / ₈ " x 7"
	Portatovaglioli		
	Napkins holder		
	Distributeur de serviettes		
	Serviettenhalter		
	Portaservilletas		

675



mm. 0,8	Portabottiglia antirollio per yacht	Ø cm. 10	H cm. 17
	Yachting non-slip bottle holder		
	Cache eau minerale avec anneau antiderapant		
	Antiroll-Spezialflaschenhalter für Yachten	Ø 3 ⁷ / ₈ "	H 6 ⁵ / ₈ "
	Portabotella antibalanceo para yacht		

905



mm. 0,8	Portagrissini	Ø cm 10	Ø 3 ⁷ / ₈ "
	Bread sticks holder	H cm. 17	H 6 ⁵ / ₈ "
	Porte gressin		
	Grissini-Halter		
	Porta bastoncillos de pan		

229



mm. 1,2 | Portasalse per fiorentina o tartara
Sauce set for Florentine or Tartar steak
Service à sauce pour Florentin ou Tartare
Sauce Set für Florentine oder Tartar Steak
Servicio para salsa por bistek Tartara y Florentina

cl. 35 (x4) | oz. 117/8 (x4)

230



mm. 1,2 | Completo portasalse per fiorentina o tartara
Complete sauce set for Florentine or Tartar steak
Service à sauce complet pour Florentin ou Tartare
Sauce Set für Florentine oder Tartar Steak
Servicio para salsa por bistek Tartara y Florentina

cm. 40 x 27 | 15 3/4" x 10 5/8"
cl. 35 (x4) | oz. 117/8 (x4)

094



mm. 1,2 | Cestino rotondo CAMELLA
Round basket
Corbeille ronde
Obstschale, rund
Frutero redondo

Ø cm. 27 | Ø 10 5/8"

098



mm. 1,2 | Vassoio CAMELLA
Tray
Plateau
Tablett
Bandeja

cm. 35 x 23 | 13 3/4" x 9 1/4"
cm. 40 x 27 | 15 3/4" x 10 5/8"

721



mm. 1,2 | Coppa termica gelato e macedonia
Insulated ice cream cup/salad fruit bowl
Coupe thermique a glace et macedonie
Isolier-Eisfruchtbecher mit Deckel
Copa térmica helado y macedonia

Ø cm. 27 | Ø 3 1/3"
cl. 15 | oz. 6

356



mm. 1,2 | Cestello portacondimenti da buffet
Basket for aromatic condiments
Corbeille pour condiments aromatiques
Buffet-Essig/Öl Flaschenhalter
Cesto para aromaticos y condimentos"

280



mm. 1,2	Set per ceviche in acciaio inossidabile 18/10	607	607
	18/10 Stainless Steel ceviche set	Ø cm. 27	Ø 10 1/2"
	Set pour ceviche en acier inoxydable 18/10	H cm. 13,5	H 5 1/4"
	Cevicheset in Rostfreie Stahl 18/10	lt. 5	gal. 1 1/3
	Cevichera en acero inoxidable 18/10	58922	58922
		Ø cm. 22	Ø 8 1/2"
		H cm. 14	H 5 1/2"
		cl. 220	oz. 74 3/8

281



mm. 1,2	Set per ceviche in policarbonato	58928	58928
	Polycarbonate ceviche set	Ø cm. 28	Ø 11"
	Set pour ceviche en polycarbonate	H cm. 17,3	H 6 5/8"
	Cevicheset in Polikarbonat	lt. 6,03	oz. 202 1/2
	Cevichera en policarbonado	58922	58922
		Ø cm. 22	Ø 8 1/2"
		H cm. 14	H 5 1/2"
		cl. 220	oz. 74 3/8

994C



mm. 1,2	Portanumero piccolo	H cm. 7	H 2 3/4"
	Mini table number stand		
	Numbers etched to order		
	Mini marquer de table		
	Mini Tischnummernständer		
Porta numero de mesa pequeño			

913



mm. 1,0	Porta badge in acciaio magnetico	cm. 8 x 4,5	3 1/7" x 1 3/4"
	Badge holder in magnetic steel		
	Porte-badge en acier magnétique		
	Badge-Halter in magnetischem Stahl		
	Porta tarjeta de acero magnético		

225



Cloche trasparente	Transparent cloche	Cloche transparente	Transparente Teller cloche	Tapa transparente	Ø cm. 28	Ø 11"

709



mm. 1,2	Portastuzzicadenti con base	cl. 5	oz. 1 3/4
	Toothpick container with base		
	Porte-cure-dents avec socle		
	Zahnstocherbehälter auf Fuss		
	Porta-palillos con base		

047



Colino da cocktail
Cocktail strainer
Passoire à cocktail
Cocktailsieb
Colador para coctelera

cm. 22 | 8 2/3"

049



Cavatappi
Cork screw / Bottle opener
Ouvre boîte - Ouvre-bouteilles
Korkenzieher
Abrebotellas

H cm. 19 | H 7 1/2"

025



Grattugia
Grater
Râpe
Reibe
Rallador

cm. 23 | 9"

048



Schiaccianoci
Nutcracker
Casse noix
Nussknacher
Rompenueces

cm. 20 | 7 7/8"

473



ATTILA
Cavatappi
Cork screw / Bottle opener
Décapsuleur
Korkenheber
Abrebotellas

cm. 10 | 3 7/8"

10001108



mm. 1,2 | Cucchiaino per caviale
Caviar spoon
Cuillère à caviar
Kaviarlöffel
Cucharita caviar

cm. 11,8 | 4 2/3"

447



JOKER
Macinapepe
Pepper mill
Moulin à poivre
Pfeffermühle
Molinillo de pimienta

Ø cm. 4 | Ø 1 1/2"
H cm. 15 | H 5 7/8"

464



ETNA
Macinasale
Salt mill
Moulin à sel
Salzmühle
Molinillo de sal

Ø cm. 4 | Ø 1 1/2"
H cm. 15 | H 5 7/8"

466



MANOLO
Macinapeperoncino
Chilli mill
Moulin à piment
Chilimühle
Molinillo de chile

Ø cm. 4 | Ø 1 1/2"
H cm. 15 | H 5 7/8"

462



PARDON
Tagliatartufi
Truffles slicer
Coupe truffes
Trüffel Hobel
Cortador de trufas

cm. 20 x 8 | 7 7/8" x 3 1/7"



THE GRILL

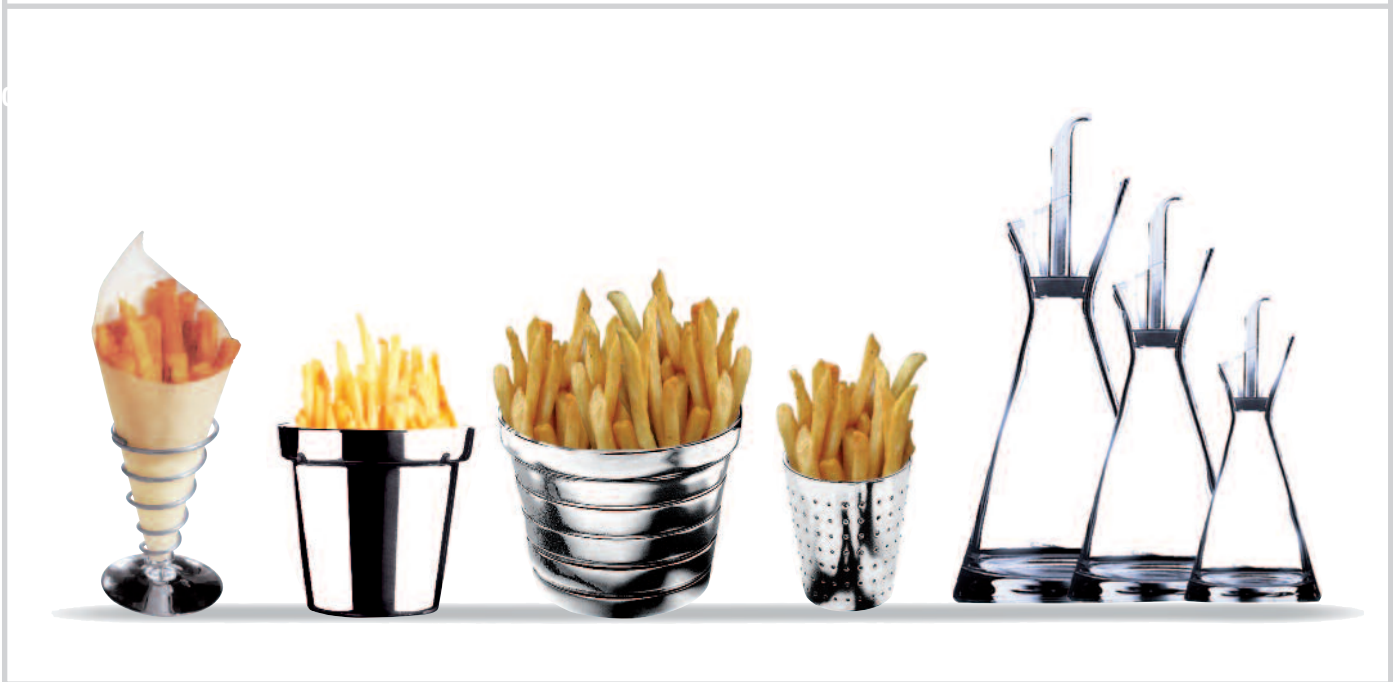

620

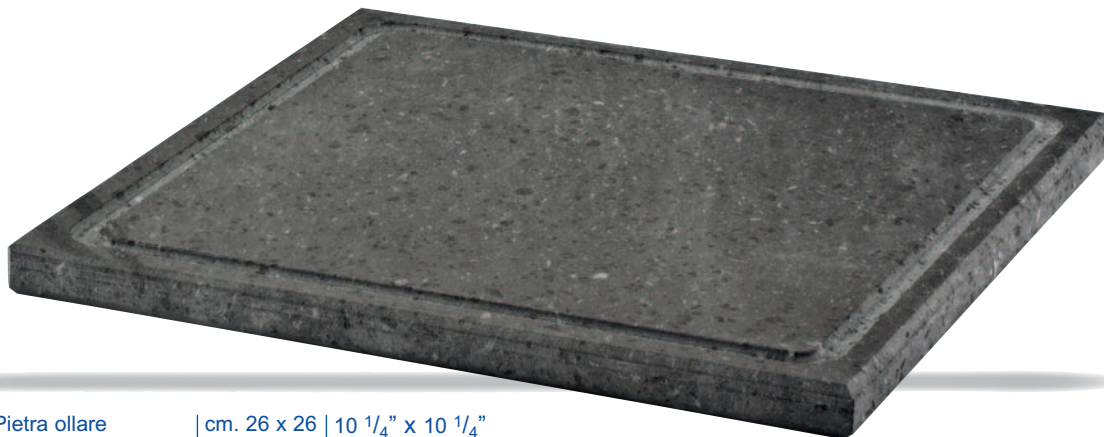

Pietra ollare Soapstone Ardoise Speckstein Pizarra	cm. 26 x 26	10 1/4" x 10 1/4"
--	-------------	-------------------

700



H cm 10	H 4"
cl. 35	oz. 11 7/8

mm.1,2
Portapatatine fritte
French fry holder for table
Porte pommes frites pour table
Kartoffenbehälter für Tisch
Porta patatas fritas por mesa

260



Ø cm 10	H 3 3/4"
H cm 9,5	Ø 3 7/8"

289



H cm. 10	H 3 7/8"
Ø cm. 6	Ø 2"

902



H cm 8	H 3 1/4"
Ø cm 7	Ø 2 3/4"

282

NEW



mm. 1,2	Braciere con pietre naturali	Ø cm. 15	Ø 5 7/8"
	Table grill with natural stones	Ø cm. 22	Ø 8 5/8"
	Brasier avec pierres naturelles	Ø cm. 32	Ø 12 5/8"
	Feuerschale mit Natursteine		
	Hoguera c/piedras naturales		

572



Ampolla Cruet Huilliere Öl-/Essigflaschen mit Spender Vinagrera	cl. 20	oz. 6 3/4
	cl. 34	oz. 11 1/2
	cl. 62	oz. 21

1136

10001136



3436

10101136
10231136



10141136
10341136
10201136



Coltello bistecca
Steak knife
Couteau entrecôte
Steakmesser
Cuchillo bistek

10001136
UNI
cm. 21,3 8 1/4"

10101136
NORMA
10231136
BOHEME

cm. 23 9 1/8"

10141136
ROMA
10201136
MICHELANGELO
10341136
NATURA

cm. 22,7 8 7/8"

1144

10001144



1145

10001145



Coltello bistecca americano
American steak knife
Couteau entrecôte américain
Amerikanisches Steakmesser
Cuchillo bistek americano

cm. 25 9 5/8"

mm. 4,0

Forchetta per bistecca
Steak fork
Fourchette à entrecôte
Tranchiergabel
Tenedor para bistek

cm. 20,3 8"

1146

10001146



Coltello arrosto
Roast knife
Couteau rôti
Tranchiermesser
Cuchillo asados

cm. 27,5 10 4/5"

574



Antipastiera quadra in vetro | cm. 24,5 x 24,5 | 9⁵/₈" x 9⁵/₈"
 Hors d'oeuvre tray in glass
 Plat à hors d'oeuvre en verre
 Vorspeisenplatte aus Glas
 Entremesera en vidrio

575



Piatto quadro in vetro | cm. 24,5 x 24,5 | 9⁵/₈" x 9⁵/₈"
 Square plate in glass
 Plateau carré en verre
 Platte, viereckig, aus Glas
 Plato cuadrado en vidrio

582



Supporto per | cm. 43 x 14 | 16⁷/₈" x 5¹/₂"
 Multifunction stand for
 Support multi-usages pour
 Schalenhalter
 Soporte multiuso para

581



Supporto per | cm. 36 x 14 | 14¹/₈" x 5¹/₂"
 Multifunction stand for
 Support multi-usages pour
 Schalenhalter
 Soporte multiuso para

570



mm. 1,2 | UNO | Ø cm. 6 | Ø 2³/₈"
 Cremiera | H cm. 8,8 | H 3¹/₂"
 Cream jug | cl. 16 | oz 5³/₈"
 Cremiér
 Sahnegießer
 Jarrita lechera

594



mm. 1,2 | UNO | Ø cm. 6 | Ø 2³/₈"
 Cremiera con piedistallo | H cm. 9 | H 3¹/₂"
 Cream jug with base | cl. 16 | oz 5³/₈"
 Cremiér avec socle
 Sahnegießer auf Fuss
 Jarrita lechera con pedestal

576



Servizio per pinzimonio in vetro	Ø cm. 28	Ø 11"
Salad set in glas	H cm. 8	H 3 1/8"
Service pour salade en verre	cl. 300	oz. 101 1/2
Service für Salat aus Glas		
Servicio para ensalada en vidrio		

290576



Servizio per pinzimonio	Ø cm. 28	Ø 11"
Set for salad serving	cl. 300	oz. 101 1/2
Service à crudités		
Set "Salatdressing"		
Servicio para ensaladas		

Ciambella termica per supporto Milleusi. La ciambella termica è usata per mantenere a lungo le temperature calde o fredde. Nel primo caso va riscaldata in forno ad una temperatura variabile tra i 160° C ed i 250° C, nel secondo caso va conservata in freezer a -14° C. In queste condizioni e in grado di mantenere la temperatura desiderata (da -5° C a +50° C) per un periodo che varia dai 20 ai 30 minuti

Thermal serving unit for multifunction stand.

The thermal serving unit is used to maintain heat or cold. In the first case, it must be heated in an oven at 160° C (+320° F) -250° C (+482° F). In the second case in a Freezer at -14° C (-57° F). In these conditions it is able to maintain the food either hot or cold for a period between 20 and 30 minutes at the desired temperature (from -5° C (-41° F) to +50° C (+122° F)).

Disque thermique pour support multi-usages. Le disque thermique est utilisé pour maintenir la chaleur ou le froid. Dans un cas, le disque est préchauffé dans le four à une température variant de 160° C a 250° C. Dans un second cas, le disque peut être refroidi jusqu'à -14° C. Dans ces conditions, le disque est en mesure de maintenir la chaleur ou la fraîcheur pendant un temp variable de 20 a 30 minutes, a la température voulue (de -5° C a +50° C).



583

Ciambella termica per supporti
Thermal serving unit for stands
Disque thermique pour support
Thermische Ringröhre für Hälter
Bobina térmica para soportes
Ø cm. 12 - Ø 4 3/4"

Der Warmhalteteller mit Thermikelement dient zum Servieren von warm- oder kalzuhaltenden Speisen, also sowohl zur Speicherung von Wärme als auch von Kälte. Zum Warmhalten erhitzt man das runde Thermikelement im Ofen auf 160 bis 250° C. Zum Kalthalten kühlt man im Gefrierfach das runde Thermikelement auf -14° C ab. Derart eingefügt in die Vertiefung des Warmhaltetellers kann man Speisen bis zu 30 min bei einer gewünschten Temperatur zwischen -5° C und +50° C kalt bzw. warm halten.

Bobina térmica para soporte multiuso. La bobina térmica puede ser utilizada para mantener el calor o el frío. En el primer caso, se calienta en el horno a una temperatura variable entre 160° C y 250° C; en el segundo, se mete en un congelador a -14° C. En estas condiciones, es capaz de mantener los alimentos calientes o fríos durante un periodo que oscila entre 20 y 30 minutos a la temperatura deseada (de -5° C a +50° C).

582



580



Pirofila ovale in fine china	cm. 37 x 24	14 5/8" x 9 3/8"
Fine china oval bowl	cl. 300	oz. 101 1/2
Plat oval en porcelaine à feu		
Auflaufform, oval aus Porzellan		
Phirophila oval en porcelana		

579



Lasagnera in fine china	cm. 34,5 x 24,5	13 5/8" x 9 5/8"
Fine china Lasagne's bowl	cl. 300	oz. 101 1/2
Plat rectangulaire en porcelaine à feu		
Auflaufform, quadr. aus Porzellan		
Fuente para Lasagne en porcelana		





P



V7

N

O

W

L7

792



Vassoio rettangolare
Rectangular tray
Plateau rectangulaire
Tablett, rechteckig
Bandeja rectangular

cm. 30 x 20 | 11 3/4" X 7 7/8"
cm. 50 x 32 | 19 3/4" X 12 3/4"

795



Tovaglietta americana
Place mat
Set de table americain en bois
Tischset aus Holz
Individual en madera

cm. 38 x 28 | 15" x 11"

796



Sottopiatto
Charger
Assiette de bienvenue
Platzteller,
Bajo plato

Ø cm. 33 | Ø 13"

791



Vassoio/Sottopiatto
Square Tray/Charger
Plateau/Assiette de bienvenue
Tablett/Platzteller,
Bandeja/Bajo plato

cm. 32 x 32 | 12 3/4" x 12 3/4"

791AC



Inserto Finger Food per vassoio quadro e rettangolare
Finger Food insert for square and rectangular tray
Insért Finger Food pour plateau carré et rectangulaire
Finger Food-Einsatz für quadratische/rechteckig Schale
Inserto para Finger Food por bandeja cuadrada y rectangular

cm. 30 x 30 | 11 7/8" x 11 7/8"

802



Portagioie/Portapasticcini
Jewel case/Petit fours case
Porte bijoux/Porte petit patisserie
Schmuckablage/Bonbonträger
Joyero/Porta dulces

cm. 15 x 15 | 6" x 6"

BUFFET



L7 Lime
Lime
Lime
Limone
Lima

O Arancio
Orange
Orange
Orange
Naranja

V7 Viola
Violet
Violet
Pflaume
Violeta

N Nero
Black
Noir
Schwarz
Negro

W Bianco
White
Blanc
Weiss
Blanco





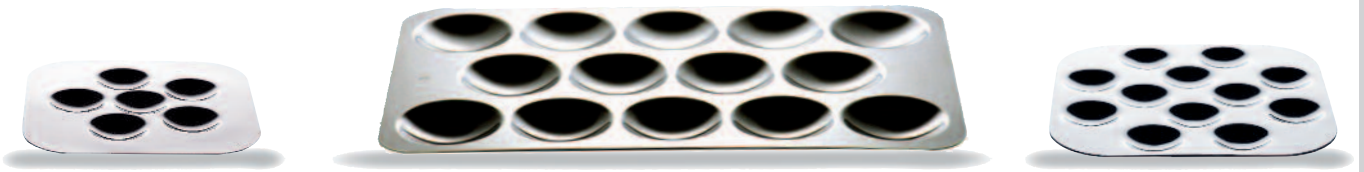

549



mm. 1,2 | Centrotavola
Tray 14 compartments
Plateau 14 pièces
Tablett 14 Einsatze
Bandeja 14 posiciones

cm. 45 x 28 | 17³/₄" x 11¹/₈"

537

53706

53712



mm. 1,2 | Mini vassoi per finger food
Mini trays for finger food
Mini plateau pour finger food
Mini Tablett für finger food
Mini bandejas por finger food

cm. 12 x 12 | 4³/₄" x 4³/₄"
cm. 15 x 15 | 5⁷/₈" x 5⁷/₈"

7011

7011E

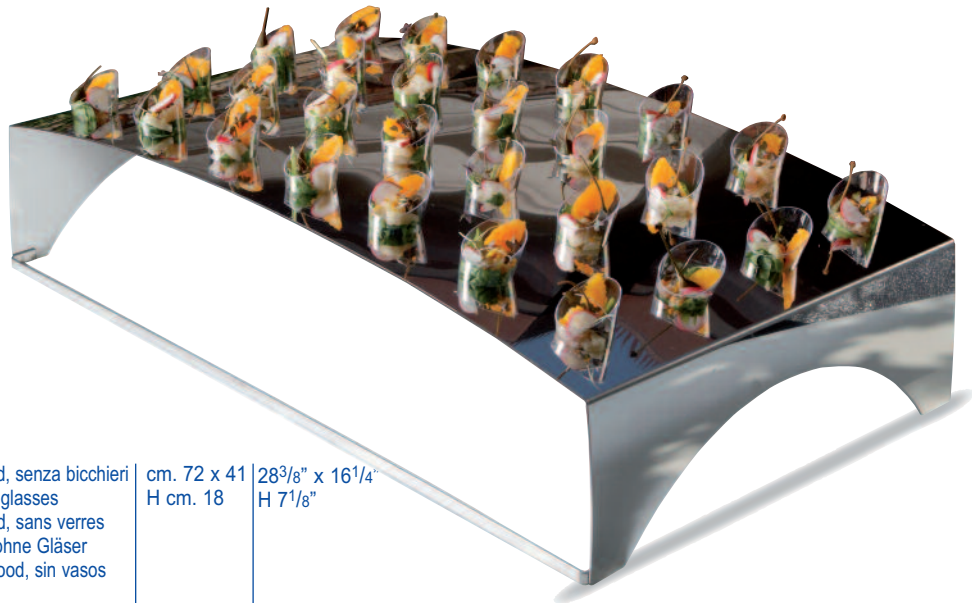

mm. 1,2 | Espositore buffet per finger food, senza bicchieri
Buffet set for finger food, w/out glasses
Service à buffet pour finger food, sans verres
Buffet Display für Finger food, ohne Gläser
Servicio para buffet por finger food, sin vasos

cm. 72 x 41 | 28³/₈" x 16¹/₄"
H cm. 18 | H 7¹/₈"

563



mm. 1,2 | Quadro piano
Square tray
Plateau carré
Tablett, quadratisch
Bandeja cuadrada

cm. 15 x 15 | 5⁷/₈" x 5⁷/₈"
cm. 22 x 22 | 8⁵/₈" x 8⁵/₈"

560



mm. 1,2 | Tondo fondo
Round bowl
Bol ronde
Obstschale, rund
Cuenco redondo

Ø cm. 12 cl. 26 | Ø 4³/₄" oz. 8³/₄
Ø cm. 15 cl. 60 | Ø 5⁷/₈" oz. 20¹/₄
Ø cm. 22 cl. 131 | Ø 8⁵/₈" oz. 44¹/₃
Ø cm. 32 lt. 3,0 | Ø 12⁵/₈" oz. 101²/₅





BUFFET



591P



Bicchiere
Glass
Gobelet
Glas
Vaso

H cm 13	H 5"
cl. 45	oz 15 1/4

588P



Bicchiere
Glass
Gobelet
Glas
Vaso

H cm 10	H 3 7/8"
cl. 33	oz. 11 1/8

1131

10521131



10521108

Mini Forchetta
Appetizer fork
Fourchette amouse
bouche
Minigabel
Mini tenedor

cm. 11,4	4 1/2"
----------	--------

Mini spoon	cm. 11,4	4 1/2"
------------	----------	--------

7012



Vassoio per canapé con bicchieri
Canape tray with glasses
Plateau à canape avec verres
Buffet Display mit Gläser
Bandeja para canapé con vasos

8 pz.	8 pcs
cm. 42 x 42	16 1/2" x 16 1/2"
17 pz.	17 pcs
cm. 42 x 72,5	16 1/2" x 28 1/2"

8 pcs	16 1/2" x 16 1/2"
17 pcs	16 1/2" x 28 1/2"

543N



Bicchiere per champagne
Champagne glass
Verre pour Champagne
Champagnerglas
Vaso por champán

H cm. 22,7	H 9"
cl. 15	oz. 5 1/8

555N

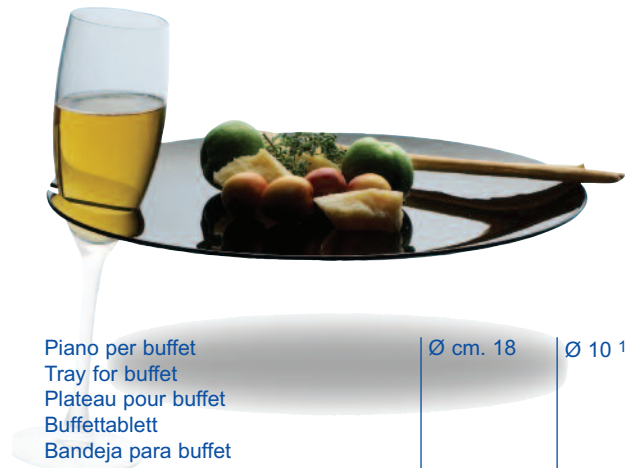

Piano per buffet
Tray for buffet
Plateau pour buffet
Buffettablett
Bandeja para buffet

Ø cm. 18	Ø 10 1/2"
----------	-----------

543

A Ambra
Amber
Ambre
Amber
Ambar



G Granato
Garnet
Grenat
Granat
Granate



Q Quarzo
Quartz
Quartz
Quarz
Cuarzo



S Smeraldo
Emerald
Emeraude
Smaragd
Esmeralda



V Olivina
Olivine
Olivine
Olivia
Olivino



Z Zaffiro
Sapphire
Saphir
Saphir
Zafiro



M Ametista
Amethyst
Amethyste
Amethyst
Amatista



W Trasparente
Transparent
Glace
Transparent
Vidrio



O Onice
Onyx
Onyx
Onyx
Onice



P Porcellana
White
Porcelain
Weiss
Porcelana



N Nero
Black
Noir
Schwarz
Negro





682



TU0687G

mm. 0,8 | Caraffa per bibite
Jug for drinks w/ice container
Carafe avec compartiment glaçons
Saftkrug mit Kühleinsatz
Jarra agua | lt. 2,5 | 84 1/2 oz.

691



TU0692V

mm. 0,8 | Infusiera con contenitore trasparente
Infuser jug
Carafe d'eau avec infuseur
Wasserkrug mit Infuser
Jarra de agua de infusión | lt. 2,5 | 84 1/2 oz.

68702



TU0687G

mm. 0,8 | AURORA
Caraffa per bibite
Jug for drinks w/ice container
Carafe avec compartiment glaçons
Saftkrug mit Kühleinsatz
Jarra agua | lt. 2 | 67 3/4 oz.

69202



TU0692V

mm. 0,8 | AURORA
Infusiera con contenitore trasparente
Infuser jug
Carafe d'eau avec infuseur
Wasserkrug mit Infuser
Jarra de agua de infusión | lt. 2 | 67 3/4 oz.

68703



TU0687G

mm. 0,8 | AURORA
Caraffa per bibite
Jug for drinks w/ice container
Carafe avec compartiment glaçons
Saftkrug mit Kühleinsatz
Jarra agua | lt. 3 | 101 1/2 oz.

69203



TU0692V

mm. 0,8 | AURORA
Infusiera con contenitore trasparente
Infuser jug
Carafe d'eau avec infuseur
Wasserkrug mit Infuser
Jarra de agua de infusión | lt. 3 | 101 1/2 oz.

7199



PALACE
Chafing Dish rettangolare con coperchio girevole a 180°
Rectangular Chafing Dish with 180° revolving cover
Chafing Dish rectangulaire avec couvercle basculant à 180°
Chafing Dish rechteckig mit 180° Rollhaube
Chafing Dish rectangular con tapa volvíble à 180°

cm. 66 x 45
H cm. 43
Lt. 6,5
26" x 17 3/4"
H 17"
gal. 1 3/4

7199A



cm. 52 x 32
20 1/2" x 12 3/4"

PALACE
Zuppiera per art. 7199
Soup station for art. 7199
Marmite à potage pour art. 7199
Suppenstation für Art. 7199
Sopera para art. 7199

Ø cm. 21,5 | Ø 8 1/2"

7201



PALACE
Chafing Dish tondo con coperchio girevole a 180°
Round Chafing Dish with 180° revolving cover
Chafing Dish rond avec couvercle basculant à 180°
Chafing Dish rund mit 180° Rollhaube
Chafing Dish rendono con tapa volvíble à 180°

Ø cm. 40
H cm. 46
Lt. 4,5
Ø 15 3/4"
H 18 1/8"
gal. 1 1/4

7201A

Ø cm. 38,5 esterno
Ø cm. 22 interno

Ø 15 1/8" outside
Ø 8 3/4" inside

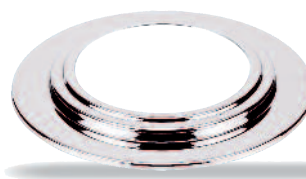

PALACE
Zuppiera per art. 7201
Soup station for art. 7201
Marmite à potage pour art. 7201
Suppenstation für Art. 7201
Sopera para art. 7201

Ø cm. 21,5 | Ø 8 1/2"

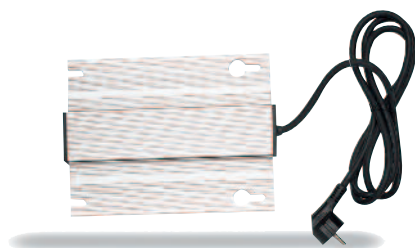

Piastra elettrica per art. 7199
Electric Heater for art. 7199
Element de chauffage électrique pour art. 7199
Heizelement für Art. 7199
Calientador eléctrico para art. 7199

7199B 110V
7199C 220V
cm. 25 x 19
9 3/4" x 7 1/2"

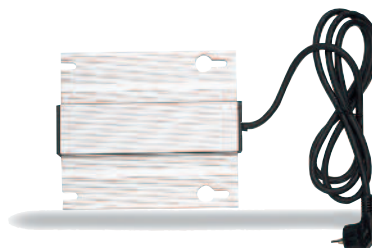

Piastra elettrica per art. 7201
Electric Heater for art. 7201
Element de chauffage électrique pour art. 7201
Heizelement für Art. 7201
Calientador eléctrico para art. 7201

7201B 110V
7201C 220V
cm. 21,5 x 18,5
8 1/2" x 7 1/4"

151



mm. 1,2 | Vassoio rettangolare
Rectangular tray
Plateau de presentation
Tablett, rechteckig
Bandeja rectangular

cm. 63 x 45
24 11/16" x 17 3/4"

7204



Coffee Urn	PALACE	Ø cm. 32	gal. 2 ³ / ₄
Coffee Urn	"	H cm. 60	H 23 ⁵ / ₈ "
Bouilleur	"	lt. 11	Ø 12 ⁵ / ₈ "
Kaffeespender	"	Ø cm. 32	Ø 12 ⁵ / ₈ "
Contenedor para café	"	H cm. 67	H 26 ³ / ₈ "
		lt. 19	gal. 5

7206



Distributore per succo di frutta	PALACE	cm. 26 x 35	10 1/4" x 13 3/4"
Juice dispenser	"	H cm. 58	H 22 7/8"
Distributeur à jus	"	lt. 7	gal. 1 7/8
Saftdispenser	"		
Contenedor para zumo de fruta	"		

7208



Doppio distributore per succo di frutta	PALACE	cm. 56 x 35
Double Juice dispenser	"	H cm. 58
Double distributeur à jus	"	lt. 14
Doppel Saftdispenser	"	22" x 13 3/4"
Doble contenidor para zumo de fruta	"	H 22 7/8"
		gal. 3 1/2

HAPPY

10001175

10001123



10001122



10001111



10001110



10001142



10001116



Ø mm.10



Nuovo sistema per il servizio delle pietanze, per evitare la caduta delle posate all'interno degli chafing. Tutta la collezione HAPPY è a pag. 69.

A new collection of serving pieces designed with a handle that securely rests on the edge of the chafing dish when not in use. The entire Happy collection can be found on page 69.

Nouveau système pour le service des plats, pour éviter la chute des couverts à l'intérieur des chafing. Toute la collection HAPPY est au pag. 69.

"HAPPY" ist eine neue platzsparende Idee, wie man von Chafing Dishes Speisen auf Teller füllen kann, ohne dass die Servierteile hineinfallen. Gesamte HAPPY Kollektion auf Seite 69.

Nuevo sistema por el servicio de las comidas, para evitar la caída de los cubiertos dentro de los chafing. Toda la colección HAPPY es a pag. 69.

Appoggia posate
Knife rest
Soutier p/couverts
Messer bank
Apoyo p/cubiertos

Largh. cm 6,5
Width 2 1/2"

7088



GALA
Chafing Dish 1/1 rettangolare con coperchio girevole a 180°
Rectangular Chafing Dish 1/1 with 180° revolving cover
Chafing Dish 1/1 rectangulaire avec couvercle basculant à 180°
Chafing Dish 1/1 rechteckig mit 180° Rollhaube
Chafing Dish 1/1 rectangular con tapa volvible à 180°

cm. 64 x 32	25 1/4" x 12 5/8"
H cm. 43,5	H 17 1/8"
lt. 6,5	gal. 1 3/4

7089



GALA
Chafing Dish tondo con coperchio girevole a 180°
Round Chafing Dish with 180° revolving cover
Chafing Dish rond avec couvercle basculant à 180°
Chafing Dish rund mit 180° Rollhaube
Chafing Dish rondondo con tapa volvible à 180°

Ø esterno cm. 40	Ø inside 11 3/4"
Ø interno cm. 30	Ø outside 15 3/4"
lt. 4,5	gal. 1 1/4

7088A

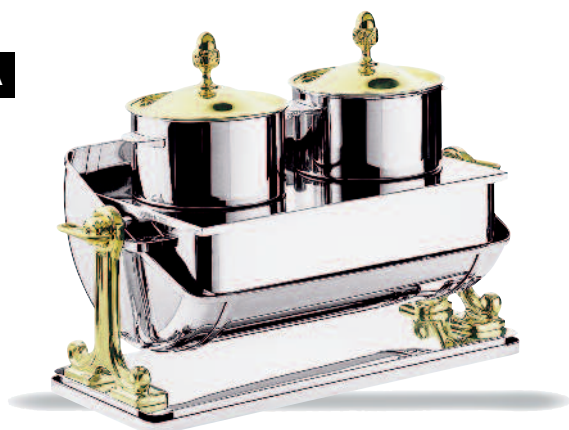

Zuppiera per art.	7088	cm. 64 x 32	25 1/4" x 12 5/8"
Soup tureen for art.	"	H cm. 43,5	H 17 1/8"
Marmite à potage pour art.	"	lt. 6,5	gal. 1 3/4
Suppenstation für art.	"		
Sopera para art.	"		

7089A



Zuppiera per art.	7089	Ø esterno cm. 40
Soup tureen for art.	"	Ø interno cm. 30
Marmite à potage pour art.	"	lt. 4,5
Suppenstation für art.	"	Ø inside 11 3/4"
Sopera para art.	"	Ø outside 15 3/4"
		gal. 1 1/4

7087



Chafing Dish 1/1 rettangolare con coperchio amovibile	cm. 61 x 30	24" x 11 3/4"
Rectangular Chafing Dish 1/1 with removable cover	H cm. 32,5	H 12 3/4"
Chafing Dish 1/1 rectangulaire avec couvercle démontable	lt. 6,5	gal. 1 3/4
Chafing Dish 1/1 rechteckig mit abnehmbarer Haube		
Chafing Dish 1/1 rectangular con tapa amovible		

7086



GIOTTO	cm. 61 x 30
Chafing Dish 1/1 rettangolare con coperchio amovibile	H cm. 32,5
Rectangular Chafing Dish 1/1 with removable cover	lt. 6,5
Chafing Dish 1/1 rectangulaire avec couvercle démontable	24" x 11 3/4"
Chafing Dish 1/1 rechteckig mit abnehmbarer Haube	H 12 3/4"
Chafing Dish 1/1 rectangular con tapa amovible	gal. 1 3/4

7090



mm. 0,8	Rinfrescatore per yogurt Yogurt cooler Rafraichisseur à yaourts Yoghurtkühler Refrigerador para yogurt	cm. 52,5 x 32,5 lt. 8	20 ⁵ / ₈ " x 12 ³ / ₄ " gal. 2
---------	--	--------------------------	---

7999



Culla portachampagne Champagne holder Porte-champagne Champagnerflaschenhalter Portabotella de champagne	"MATHUSALEM" lt. 6 - gal. 1 1/2 "SALMANAZAR" lt. 9 - gal. 2 1/2 cm 45 x 31 - H cm 65 17 3/4" x 12 1/4" - H 25 1/2"
--	---

236

NEW



mm. 1,2	Rinfrescatore per yogurt Yogurt cooler Rafraichisseur à yaourts Yoghurtkühler Refrigerador para yogurt	Ø cm.38 H cm. 9 lt. 3,0	Ø 15" H 3 1/2" oz. 101 2/5
---------	--	-------------------------------	----------------------------------

7092



7092

Candelabro a 1 fiamma Candlestick Chandelier Leuchter 1-flammig Candelabro	Silverplated H cm. 28,5 H 11 1/4"
--	---



7093

Candelabro a 3 fiamme Candelabra, 3 arms Chandelier 3 flammes Leuchter 3-flammig Candelabro 3 luces	Silverplated H cm. 34,5 H 13 5/8"
---	---



7094

Candelabro a 5 fiamme Candelabra, 5 arms Chandelier 5 flammes Leuchter 5-flammig Candelabro 5 luces	Silverplated H cm. 34,5 H 13 5/8"
---	---

7094



641



mm. 1,2	Caffetteria	BOMBATA	Tazze	1	cl. 15	5 1/8 oz.
	Coffee pot	»	Cups	2	cl. 27	9 1/8 oz.
	Cafetière	»	Bols	4	cl. 37	12 1/2 oz.
	Kaffeekanne	»	Tassen	6	cl. 55	18 5/8 oz.
	Cafetera	»	Tazas	8	cl. 85	28 3/4 oz.
				10	cl. 110	37 1/4 oz.
				12	cl. 150	50 3/4 oz.
				16	cl. 200	67 5/8 oz.

642



mm. 1,2	Teiera	BOMBATA	Tazze	1	cl. 20	6 3/4 oz.
	Tea pot	»	Cups	2	cl. 35	11 7/8 oz.
	Théière	»	Bols	4	cl. 50	16 7/8 oz.
	Teekanne	»	Tassen	6	cl. 70	23 5/8 oz.
	Tetera	»	Tazas	8	cl. 95	32 1/8 oz.
				10	cl. 120	40 5/8 oz.

643



mm. 1,2	Lattiera	BOMBATA	Tazze	1/2	cl. 10	3 3/8 oz.
	Milk jug	»	Cups	1	cl. 15	5 1/8 oz.
	Pot à lait	»	Bols	2	cl. 27	9 1/8 oz.
	Milchkanne	»	Tassen	4	cl. 37	12 1/2 oz.
	Jarra lechera	»	Tazas	6	cl. 55	18 5/8 oz.
				8	cl. 85	28 3/4 oz.
				10	cl. 110	37 1/4 oz.
				12	cl. 150	50 3/4 oz.
			16	cl. 200	67 5/8 oz.	

644



644P

mm. 1,2	Zuccheriera	BOMBATA	Tazze	2	cl. 15	5 1/8 oz.
	Sugar bowl	»	Cups	4	cl. 20	6 3/4 oz.
	Sucrier	»	Bols	6	cl. 27	9 1/8 oz.
	Zuckerdose	»	Tassen	8	cl. 35	11 7/8 oz.
	Azucarero	»	Tazas			

647



mm. 1,2	Caraffa termica per acqua c/fermaghiaccio	BOMBATA	cl. 150
	Insulated water pitcher w/ice-trap	»	
	Carafe à eau avec attrape-glace	»	
	Isolier-Wasserkrug	»	50 3/4 oz.
	Jarra agua c/tope	»	

645



mm. 1,2	Caffetteria termica	BOMBATA	Tazze	4	cl. 30	10 1/8 oz.
	Insulated coffee pot	»	Cups	6	cl. 60	20 1/4 oz.
	Cafetière thermique	»	Bols	12	cl. 150	50 3/4 oz.
	Isolier-Kaffeekanne	»	Tassen			
	Cafetera térmica	»	Tazas			

621



mm. 1,2	Caffetteria con piedistallo BOMBATA	Tazze	1	cl. 15	5 1/8 oz.
	Coffee pot with base »	Cups	2	cl. 27	9 1/8 oz.
	Cafetière avec socle »	Bols	4	cl. 37	12 1/2 oz.
	Kaffeekanne auf Fuss »	Tassen	6	cl. 55	18 5/8 oz.
	Cafetera con pedestal »	Tazas	8	cl. 85	28 3/4 oz.
			10	cl. 110	37 1/4 oz.
			12	cl. 150	50 3/4 oz.
		16	cl. 200	67 5/8 oz.	

622



mm. 1,2	Teiera con piedistallo BOMBATA	Tazze	2	cl. 35	11 7/8 oz.
	Tea pot with base »	Cups	4	cl. 50	16 7/8 oz.
	Théière avec socle »	Bols	6	cl. 70	23 5/8 oz.
	Teekanne auf Fuss »	Tassen	8	cl. 95	32 1/8 oz.
	Tetera con pedestal »	Tazas	10	cl. 120	40 7/8 oz.

623



mm. 1,2	Lattiera con piedistallo BOMBATA	Tazze	1	cl. 15	5 1/8 oz.
	Milk jug with base »	Cups	2	cl. 27	9 1/8 oz.
	Pot à lait avec socle »	Bols	4	cl. 37	12 1/2 oz.
	Milchkanne auf Fuss »	Tassen	6	cl. 55	18 5/8 oz.
	Jarra lechera con pedestal »	Tazas	8	cl. 85	28 3/4 oz.
			10	cl. 110	37 1/4 oz.
			12	cl. 150	50 3/4 oz.
		16	cl. 200	67 5/8 oz.	

624



624P

mm. 1,2	Zuccheriera con piedistallo BOMBATA	Tazze	2	cl. 15	5 1/8 oz.
	Sugar bowl with base »	Cups	4	cl. 20	6 3/4 oz.
	Sucrier avec socle »	Bols	6	cl. 27	9 1/8 oz.
	Zuckerdose auf Fuss »	Tassen	8	cl. 35	11 7/8 oz.
	Azucarero con pedestal »	Tazas			

646



mm. 1,2	Caffetteria termica con piedistallo BOMBATA	Tazze	4	cl. 30	10 1/8 oz.
	Insulated coffee pot with base »	Cups	6	cl. 60	20 1/4 oz.
	Cafetière thermique avec socle »	Bols	12	cl. 150	50 3/4 oz.
	Isolier-Kaffeekanne auf Fuß »	Tassen			
	Cafetera térmica con pedestal »	Tazas			

648



mm. 1,2	Caraffa termica c/fermaghiaccio e piedistallo BOMBATA			cl. 150	
	Insulated water pitcher w/ice-trap and base »				
	Carafe à eau avec attrape-glace et socle »				
	Isolier-Wasserkrug auf Fuss »				50 3/4 oz.
	Jarra agua c/tope y pedestal »				

940



mm. 1,2	Servizio per caffè macchiato Café au lait set Service pour café au lait Café au Lait-Set Juego café au lait	H cm 18 cl. 102	H 7 1/8" oz. 34
---------	---	--------------------	--------------------

940/5



mm. 1,2	Servizio per caffè macchiato 5pcs Sugar, milk and coffee set Service sucre, lait et café 5 pièces Milch - Kaffee - Zucker Set 5-Tlg. Juego leche, café y azúcar 5 piezas	cl. 15 (x5)	oz. 5 1/8 (x5)
---------	--	-------------	----------------

940/3



mm. 1,2	Servizio per zucchero 3 pezzi Sugar set 3 pcs. Service pour sucre 3 pièces Zucker Menage 3-Tlg Juego azúcar 3 piezas	cl. 15 (x3)	oz. 5 1/8 (x3)
---------	--	-------------	----------------

940/4



mm. 1,2	Servizio per zucchero 4 pezzi Sugar set 4 pcs. Service pour sucre 4 pièces Sahne-/Zucker-Set 4-Tlg Juego azúcar 4 piezas	cl. 15 (x4)	oz. 5 1/8 (x4)
---------	--	-------------	----------------

649



mm. 1,2	Bricco Jug Cruche Milchkännchen Jarra	BOMBATA	cl. 20	oz. 6 3/4
---------	---	---------	--------	-----------

771



mm. 0,8	Molla per zucchero Sugar tongs Pince à sucre Zuckerzange Pinzas azúcar	Lungh. cm. 14	Length 5 1/2"
---------	--	---------------	---------------



361



mm. 1,2	Caffetteria	IMMAGINA	Tazze	1	cl. 10	3 3/8 oz.
	Coffee pot	»	Cups	4	cl. 34	11 1/2 oz.
	Cafetière	»	Bols	6	cl. 50	16 7/8 oz.
	Kaffeekanne	»	Tassen	8	cl. 75	25 3/8 oz.
	Cafetera	»	Tazas	10	cl. 97	32 4/5 oz.
				16	cl. 200	67 5/8 oz.

362



mm. 1,2	Teiera	IMMAGINA	Tazze	2	cl. 35	11 7/8 oz.
	Tea pot	»	Cups	4	cl. 50	16 7/8 oz.
	Théière	»	Bols	6	cl. 75	25 3/8 oz.
	Teekanne	»	Tassen	8	cl. 97	32 4/5 oz.
	Tetera	»	Tazas			

363



mm. 1,2	Lattiera	IMMAGINA	Tazze	1	cl. 10	3 3/8 oz.
	Milk jug	»	Cups	4	cl. 34	11 1/2 oz.
	Pot à lait	»	Bols	6	cl. 52	17 5/8 oz.
	Milchkanne	»	Tassen	8	cl. 75	25 3/8 oz.
	Jarra lechera	»	Tazas	16	cl. 200	67 5/8 oz.

364



mm. 1,2	Zuccheriera porta bustine	IMMAGINA	364A			
	Sugar packets holder	»	364A	cl. 20	6 3/4 oz.	
	Sucrier à sachets	»	364A			
	Zuckerdose/Zuckerstangengefäß	»	364A	cl. 22	7 1/2 oz.	
	Azucarera	»	364B	cl. 10	3 3/8 oz.	

366

NEW



mm. 1,2	Caffetteria termica	IMMAGINA	Tazze	6	cl. 50	
	Insulated coffee pot	»	Cups	8	cl. 75	
	Cafetière thermique	»	Bols			
	Isolier-Kaffeekanne	»	Tassen		16 7/8 oz.	
	Cafetera térmica	»	Tazas		25 3/8 oz.	

NEW



mm. 1,2	Teiera termica	IMMAGINA	Tazze	4	cl. 50	
	Insulated tea pot	»	Cups	6	cl. 75	
	Théière thermique	»	Bols			
	Isolier-Teekanne	»	Tassen		16 7/8 oz.	
	Tetera térmica	»	Tazas		25 3/8 oz.	

367

631



mm. 1,2	Caffetteria	PARTY	Tazze	2	cl. 24	8 1/8 oz.
	Coffee pot	»	Cups	4	cl. 34	11 1/2 oz.
	Cafetière	»	Bols	6	cl. 46	15 1/2 oz.
	Kaffeekanne	»	Tassen	8	cl. 63	21 1/8 oz.
	Cafetera	»	Tazas	10	cl. 100	33 7/8 oz.
				12	cl. 150	50 3/4 oz.
				16	cl. 200	67 5/8 oz.

632



mm. 1,2	Teiera	PARTY	Tazze	2	cl. 40	13 1/2 oz.
	Tea pot	»	Cups	4	cl. 50	16 7/8 oz.
	Théière	»	Bols	6	cl. 68	23 oz.
	Teekanne	»	Tassen	8	cl. 90	30 1/2 oz.
	Tetera	»	Tazas			

633



mm. 1,2	Lattiera	PARTY	Tazze	1	cl. 10	3 3/8 oz.
	Milk jug	»	Cups	2	cl. 24	8 1/8 oz.
	Pot à lait	»	Bols	4	cl. 34	11 1/2 oz.
	Milchkanne	»	Tassen	6	cl. 46	15 1/2 oz.
	Jarra lechera	»	Tazas	8	cl. 63	21 1/4 oz.
				10	cl. 100	33 7/8 oz.
				12	cl. 150	50 3/4 oz.
				16	cl. 200	67 5/8 oz.

634



mm. 1,2	Zuccheriera	PARTY	Tazze	4	cl. 15	5 1/8 oz.
	Sugar bowl	»	Cups	6	cl. 22	7 1/2 oz.
	Sucrier	»	Bols	8	cl. 28	9 1/2 oz.
	Zuckerdose	»	Tassen			
	Azucarero	»	Tazas			

635



mm. 1,2	Brocca per acqua con fermaggiaccio	PARTY	cl. 100
	Water pitcher with ice-trap	»	cl. 200
	Carafe à eau avec attrape-glace	»	
	Eiswaserkrug	»	33 4/5 oz.
	Jarra agua c/tope	»	67 2/3 oz.

651



mm. 1,2	Caffetteria	LADY	Tazze	2	cl. 25	8 1/2 oz.
	Coffee pot	»	Cups	4	cl. 37	12 1/2 oz.
	Cafetière	»	Bols	6	cl. 52	17 5/8 oz.
	Kaffeekanne	»	Tassen	8	cl. 70	23 5/8 oz.
	Cafetera	»	Tazas	10	cl. 100	33 7/8 oz.
				12	cl. 150	50 3/4 oz.
				16	cl. 200	67 5/8 oz.

652



mm. 1,2	Teiera	LADY	Tazze	2	cl. 40	13 1/2 oz.
	Tea pot	»	Cups	4	cl. 55	18 5/8 oz.
	Théière	»	Bols	6	cl. 70	23 5/8 oz.
	Teekanne	»	Tassen	8	cl. 97	32 3/4 oz.
	Tetera	»	Tazas			

653



mm. 1,2	Lattiera	LADY	Tazze	1	cl. 10	3 3/8 oz.
	Milk jug	»	Cups	2	cl. 25	8 1/2 oz.
	Pot à lait	»	Bols	4	cl. 37	12 1/2 oz.
	Milchkanne	»	Tassen	6	cl. 52	17 5/8 oz.
	Jarra lechera	»	Tazas	8	cl. 70	23 5/8 oz.
				10	cl. 100	33 7/8 oz.
				12	cl. 150	50 3/4 oz.
			16	cl. 200	67 5/8 oz.	

654



mm. 1,2	Zuccheriera	LADY	Tazze	2	cl. 13	4 3/8 oz.
	Sugar bowl	»	Cups	4	cl. 18	6 1/8 oz.
	Sucrier	»	Bols	6	cl. 22	7 1/2 oz.
	Zuckerdose	»	Tassen	8	cl. 30	10 1/8 oz.
	Azucarero	»	Tazas			

516



mm. 1,2	Portabustine da zucchero Sugar packet holder Pot à sucre Zuckerstangengefäß Azucarera	cm. 10 x 7 H cm. 3	4" x 2 3/4" H 1 1/8"
---------	---	-----------------------	-------------------------

206

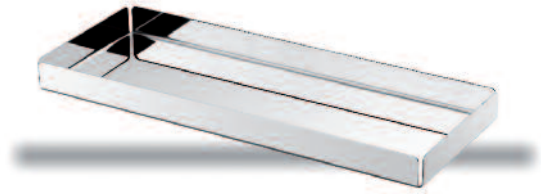

mm. 1,2	Vassoio per pasticceria Patisserie tray Plateau pour patisserie Patisserie Tablett Bandeja para pasteleria	cm. 26 x 12 cm. 60 x 12	10 1/4" x 4 3/4" 23 3/5" x 10 1/5"
---------	--	----------------------------	---------------------------------------

136



mm. 1,2	Vassoio Tray Plateau Kaffeetablett Bandeja	CAFE' VIENNA » » » »	cm. 26 x 22	10 1/4" x 8 2/3"
---------	--	----------------------------------	-------------	------------------

704

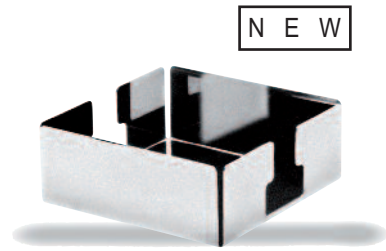

mm. 1,2	Portatovaglioli Napkin holder Distributeur de serviettes Serviettenhalter Portaservilletas	cm. 13 x 13	5 1/9" x 5 1/9"
---------	--	-------------	-----------------

902



mm. 1,2	Portabastoncini da zucchero Sugar bags holder Pot à sucre Zuckerstangengefäß Azucarera	Ø cm 7 H cm 8	H 3 1/4" Ø 2 3/4"
---------	--	------------------	----------------------

700



mm. 1,2	Zuccheriera Sugar container Sucriere Zuckerdose Azucarero	Ø cm 10 cl.35	Ø 4" oz 11 7/8
---------	---	------------------	-------------------

594



mm. 1,2	Cremiera con piedistallo UNO	cl.16	oz. 5 ³ / ₈
	Cream jug with base »		
	Cremiér avec socle »		
	Sahnegießer/Milchkännchen »		
	Jarrita lechera con pedestal »		

595



mm. 1,2	Zuccheriera con piedistallo UNO	cl. 24	oz. 8 ¹ / ₈
	Sugar bowl with base »		
	Sucrier avec socle »		
	Zuckerdose auf Fuss »		
	Azucarero con pedestal »		

499



mm. 1,2	MINIMA Portabustine da zucchero 4 sc. Sugar packets holder 4 compt. Pot à sucre 4 comp. Zuckerstangengefäß 4 Eins. Azucarera 4 comp.	cm.15 x 11 H.cm.14	5 ⁷ / ₈ " x 4 ³ / ₈ " H. 5 ¹ / ₂ "
---------	---	-----------------------	---

706



mm. 1,2	Porta salviette lavamani Tray for hand towels Plateau porte serviettes Tablett für Stoffservietten Bandeja portaservilletas	cm. 15 x 9	5 ⁷ / ₈ " x 3 ¹ / ₂ "
---------	---	------------	---

703



mm.1,2	Set per latte macchiato Latte Macchiato Set Service pour Latte Macchiato Latte Macchiato-Set Servicio para café con leche	Ø cm. 10 cl. 36	Ø 3 ⁷ / ₈ " oz. 12 ³ / ₈
--------	---	--------------------	---

10201144



mm. 3,0	Cucchiaino cappuccino Cappuccino spoon Cuillère cappuccino Cappuccinolöffel Cucharita cappuccino	Lungh. cm. 16,5	Length 6 ¹ / ₂ "
---------	--	-----------------	--



803C

Coffee Design Kit

Cucchiaino caffè, bicchiere in vetro, piattino in ardesia.

Teaspoon, transparent cup, natural stone slate coaster.

Cuillère, tasse transparente, sous tasse en ardoise naturelle.

Kaffeelöffel, Becher auf Glass, Untersatz in Schiefer Naturstein.

Cucharita, taza transparente, posavasos en elegante pizarra piedra natural.



Coffee Design Kit è un rivoluzionario kit che ci permette di stupire i nostri ospiti con un nuovo concetto di dessert gustosi ed originali, di grande effetto, ma facili e veloci da preparare.

Coffee Design Kit si compone di 1 inedito bicchierino trasparente modellato a fasce orizzontali, per facilitare le dosi dei vari strati, 1 cucchiaino in acciaio 18/10 finitura satinata, progettato appositamente per facilitare la stratificazione degli ingredienti, 1 elegante sottobicchiere in pietra naturale di ardesia.

Coffee Design Kit is a revolutionary kit that allows us to surprise our guests with a new concept of tasty and original desserts, highly impressive, yet easy and quick to prepare. Coffee Design Kit is made of an unique transparent cup shaped with horizontal bands to facilitate the doses of the various layers, a teaspoon in 18/10 stainless steel in brushed finishing specifically designed to facilitate the layering of the ingredients, a coaster in elegant natural stone slate.

Coffee Design Kit est un kit révolutionnaire qui nous permet d'émerveiller nos hôtes avec un nouveau concept de desserts originaux et savoureux, de grand effet, mais faciles et rapides à préparer.

Coffee Design Kit est composé de une tasse transparente uniques avec des lignes horizontales afin de faciliter les doses des différentes couches, de un cuillère en acier 18/10 en finition satinée spécialement conçues pour faciliter la superposition des ingrédients, une élégante sous tasse en ardoise naturelle.

Das Coffee-Design-Kit ist ein revolutionäres Set, das es uns ermöglicht, unsere Gäste mit einem neuen Konzept von leckeren und originellen Desserts zu überraschen, sehr beeindruckend, und dennoch einfach und schnell zuzubereiten.

Das Coffee Design Kit besteht aus 1 einzigartigen, transparenten Becher, jeweils mit horizontalen Streifen versehen, um die Mengenbestimmung der verschiedenen Schichten zu erleichtern, 1 Kaffeelöffel aus Edelstahl 18/10 in mattem Finish, die speziell abgestimmt sind auf das Konzept, 1 Untersatz in eleganten Schiefer Naturstein

Coffee Design Kit es un kit revolucionario que permite sorprender a nuestros invitados con un nuevo concepto de postres sabrosos y originales, muy impresionantes, pero fáciles y rápidos de preparar.

Coffee Design Kit consiste en 1 taza transparente de forma única con bandas horizontales, para facilitar las dosis de varias capas, 1 cucharita en acero inoxidable de 18/10 en acabado satinado, diseñadas específicamente para facilitar la estratificación de los ingredientes, 1 posavasos en elegante pizarra piedra natural.



941

661

665



Portacucchiai per bar
Coffee spoons stand
Pot à cuillères pour bar
Löffelbecher
Porta-cucharitas para bar
mm. 0,8

Ø cm. 9 | Ø 3 1/4"

Secchiello per spumante
Sparkling wine cooler
Seau à champagne
Wein- und Sektkühler
Cubo para champany
mm. 1,2

Ø cm. 18 | Ø 7 1/4"
H cm. 18,5 | H 7 1/8"
lt. 4 | gal. 1

Secchiello per ghiaccio
Ice-bucket with knobs
Seau à glaçons
Eisgefäß
Cubitera hielo
mm. 0,8

Ø cm. 13,5 | Ø 5 3/8"
H cm. 13 | H 5 1/8"
cl. 150 | oz. 50 3/4

708



mm. 1,2

Piattino portamonete
Cash tray
Plat à addition
Zahlteller
Bandeja porta monedas

cm. 11 x 15 | 4 3/8" x 5 7/8"

545



548

545
546
547

mm. 1,2

Dosatore
Jigger
Doseur
Barmaß
Medida

cl. 2 e 4 | oz. 1
oz. 1 3/8

Agitatore
Shaker
Shaker
Shaker
Coctelera

cl. 25 | oz. 8 1/2
cl. 50 | oz. 16 7/8
cl. 75 | oz. 25 3/8

729



10001151

mm. 1,2

Coppa per punch
Punch bowl
Bol à punch
Punchbowl
Cazo ponche

Ø cm. 38 | lt. 15
Ø 15" | 4 gal.

Mestolo coppa per punch
Punch bowl ladle
Cuiller à punch
Bowlenlöffel
Cazo ponche

551



colori a pag. 253
available colors at page 253
couleurs disponibles
à page 253
Sehen Sie erhaltlichen Farben
an Seite 253
Ver colores à pagina 253

mm. 0,8

Agitatore Boston con bicchiere
Boston shaker
Boston shaker à cocktail et verre
Boston Shaker
Coctelera Boston

cl. 75 | oz. 25 3/8

380



382
Lungh. cm. 17,5
Length 6⁷/₈"

mm. 1,5

mm. 1,2

ERGONOMICA
Secchiello e molla per ghiaccio
Ice bucket and ice tongs
Seau à glaçons et pince à glaçons
Eisgefäß und Eiszange
Cubitera hielo y pinzas hielo

cl. 200

oz. 67 ⁵/₈

381



mm. 1,2

ERGONOMICA
Secchiello per spumante
Sparkling wine cooler
Seau à champagne
Wein-und Sektkühler
Cubo para champany

lt. 4,5

gal. 1¹/₄

683



mm. 1,2

Secchio per ghiaccio
Ice bucket with grill
Seau à glaçons
Eisgefäß
Cubitera hielo

Ø cm.14
H.cm.13
cl. 150

Ø 5¹/₂"
H. 5¹/₈"
oz. 50³/₄

mm. 1,2

Secchio per spumante
Sparkling wine cooler
Seau à champagne
Wein-und Sektkühler
Cubo para champany

Ø cm.23
H cm.22,5
lt. 8,5

Ø 9"
H 8⁷/₈"
gal. 2¹/₄

684



941



mm. 1,2

Portacannuce
Straw holder
Porta pailles
Strohalm Halter
Porta-palillas

Ø cm. 9

Ø 3 ¹/₄"

10001150



mm. 1,2

Golf club mixer spoon
Golf club mixer spoon
Golf crosse pour cocktail
Golf Schlegel für Long drink
Golf club cucharita coctél

cm. 16,5

6 ¹/₂"

686



NEW

mm. 1,2 | Champagnera 5 bott. c/pied.
Giant Champagne bucket 5 bot.
Seau à champagne p/5 bout.
Champagner Bowl 5 Fäsche
Cubo para champagne p/5 bot.

Ø cm. 40	Ø 15 3/4"
H cm. 38,5	H 15 1/6"
lt. 15	gal. 4

NEW



685

mm. 1,2 | Champagnera 5 bott. s/pied.
Giant Champagne bucket 5 bot.
Seau à champagne p/5 bout.
Champagner Bowl 5 Fäsche
Cubo para champagne p/5 bot.

Ø cm. 40	Ø 15 3/4"
H cm. 21,8	H 8 3/5"
lt. 15	gal. 4

438



mm. 1,2 | OVO
Secchiello per spumante
Sparkling wine cooler
Seau à champagne
Wein- und Sektkühler
Cubo para champany

Ø cm. 19	Ø 7 1/2"
H cm. 22	H 8 5/8"
lt. 4,5	gal. 1 1/4

439



mm. 1,2 | OVETTO
Secchiello per ghiaccio
Ice-bucket
Seau à glaçons
Eisgefäß
Cubitera hielo

Ø cm. 11	Ø 4 3/8"
H cm. 13	H 5 1/8"
cl. 100	oz. 33 7/8

689



mm. 1,2 | Secchiello per spumante
Sparkling wine cooler
Seau à champagne
Wein- und Sektkühler
Cubo para champany

Ø cm. 19	Ø 7 1/2"
H cm. 20	H 7 3/4"
lt. 2,5	oz. 84 1/2

688



mm. 1,2 | Secchiello per ghiaccio
Ice-bucket
Seau à glaçons
Eisgefäß
Cubitera hielo

Ø cm. 11	Ø 4 3/8"
H cm. 12,5	H 4 7/8"
cl. 55	oz. 18 5/8

972

973



972

973

973P

972P

mm. 1,2

972-972P
PALACE
Secchiello per ghiaccio
Ice bucket
Seau à glaçons
Eisgefäß
Cubitera hielo

Ø cm 15
H cm 18
cl.150

Ø 5 1/8"
H 7 1/8"
oz. 50 3/4

mm. 1,2

973-973P
PALACE
Secchiello per spumante
Sparkling wine cooler
Seau à champagne
Wein- und Sektkühler
Cubo para champany

Ø cm 20,5
H cm 24,5
lt. 5,0

Ø 8 1/8"
H 9 5/8"
gal. 1 1/3

666F

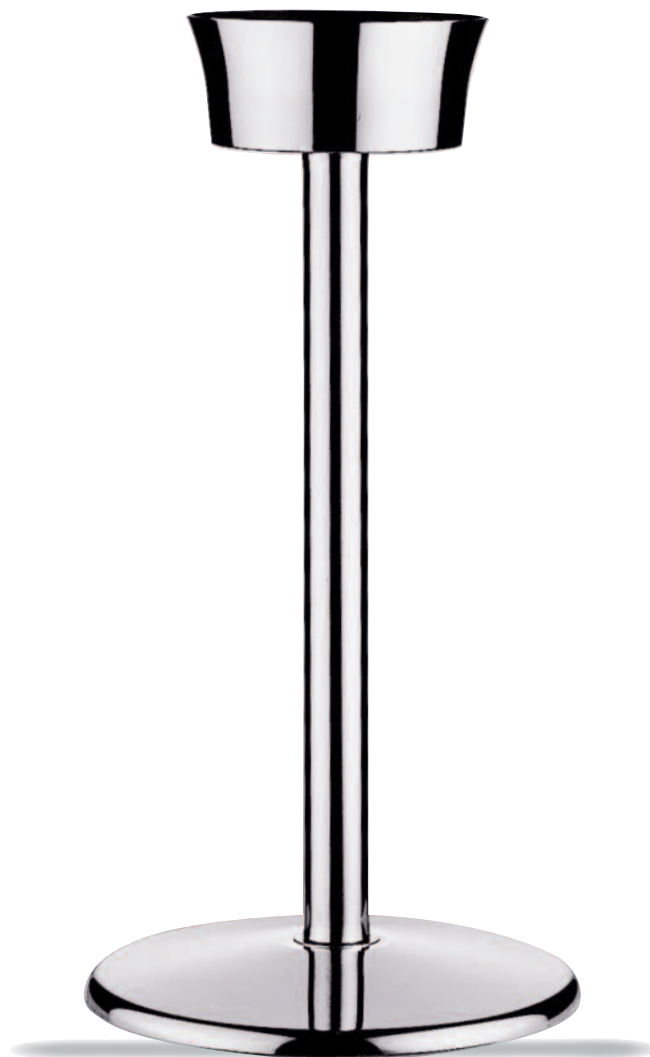

mm. 1,2

PALACE
Colonna portasecchiello spumante
Wine cooler stand w/weighted base
Pied pour seau à champagne
Weinkühlerständer
Columna porta cubo champany

H cm. 67,5 H 26 5/8"

84501



mm. 1,2 | DOLCE VITA
Portaggiaccio termico con coperchio
Insulated ice-bucket with lid
Seau à glaçons thermique
avec couvercle
Isolier-Eisgefäß
Cubitera hielo con tapa

84504



Ø cm 14 | Ø 5 1/2"
H cm 13 | H 5"
cl.72 | oz. 24 1/3
Ø cm 24 | Ø 9 1/2"
H cm 22 | H 8 5/8"
lt. 4,0 | gal. 1

856



mm. 1,2 | DOLCE VITA
Secchiello per spumante
Sparkling wine cooler
Seau à champagne
Wein- und Sektkühler
Cubo para champany



Ø cm 14 | Ø 5 1/2"
H cm 13 | H 5"
cl.125 | oz. 42 1/4
Ø cm 24 | Ø 9 1/2"
H cm 22 | H 8 5/8"
lt. 4,0 | gal. 1

666G

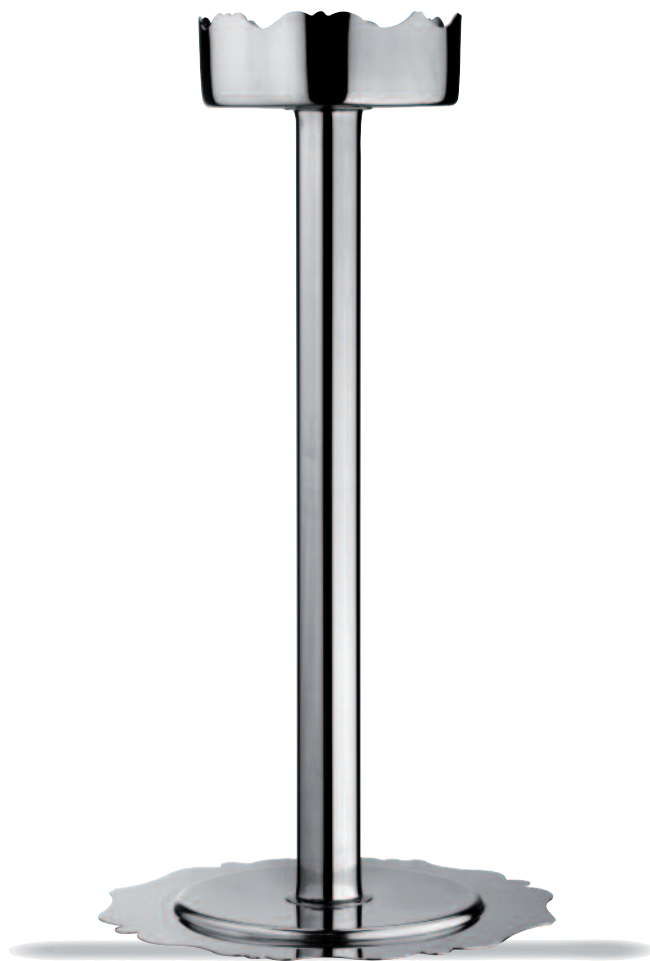

mm. 1,2 | DOLCE VITA
Colonna portasecchiello spumante
Wine cooler stand
Pied pour seau à champagne
Weinkühlerstand
Columna porta cubo champany

H cm. 62 | H 24 3/8"

670



670 mm.1,2
 Secchiello per ghiaccio
 Ice bucket with grill
 Seau à glaçons
 Eisgefäß
 Cubitera hielo
 Ø cm.14 - H cm.13 - cl. 150
 Ø 5 1/2" - H 5 1/8" - oz. 50 3/4



662 mm.1,2
 Rinfrescavino bianco da 1 bottiglia
 White wine cooler for 1 bottle
 Seau à vin blanc
 Weissweinkühler für 1 Flasche
 Cubo para refrescar 1 botella de vino blanco
 Ø cm.16 - H cm.20 - lt. 3
 Ø 6 1/4" - H 7 7/8" - oz. 101 1/2



663 mm.1,2
 Rinfrescavino bianco da 1 bottiglia
 White wine cooler for 1 bottle
 Seau à vin blanc
 Weissweinkühler für 1 Flasche
 Cubo para refrescar 1 botella de vino blanco
 Ø cm.18 - H cm.21 - lt. 4,5
 Ø 7 1/8" - H 8 1/4" - gal. 1 1/4



664

664 mm.1,2
 Rinfrescavino spumante da 2/3 bottiglie o Magnum
 Sparkling wine cooler for 2/3 bottles or Magnum
 Seau à champagne 2/3 bouteilles ou Magnum
 Champagnerkühler für 2/3 Flaschen oder Magnum
 Cubo para refrescar 2/3 botellas de vino spumante
 Ø cm.22,5 - H cm.23 - lt. 8,5
 Ø 8 7/8" - H 9" - gal. 2 1/4

666

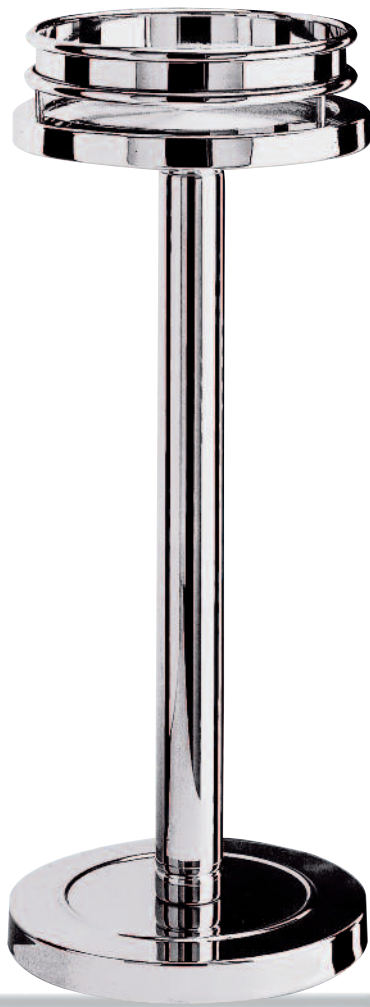

mm. 1,2 | Colonna portasecchiello spumante | H cm. 65 | H 25 5/8"
 Wine cooler stand
 Pied pour seau à champagne
 Weinkühlerständer
 Columna porta cubo champany

67704



67701

mm. 0,8 | Portaghiaccio termico con coperchio | lt. 3/4 | oz. 25 3/8
 Insulated ice-bucket with lid | lt. 4 | gal. 1
 Seau à glaçon thermique avec couvercle
 Isolier-Eisgefäß
 Cubitera hielo con tapa

676



mm. 0,8 | Glacette termica per 1 bottiglia | Ø cm. 13 | Ø 5 1/8"
 Insulated glacette for 1 bottle | H cm. 20 | H 7 7/8"
 Glacette thermique pour 1 bouteille | cl. 150 | oz. 50 3/4
 Getränkeköhler 1 Flasche
 Cubo térmico para 1 botella

681



681 mm.1,2

Rinfrescavino spumante da 2/3 bottiglie o Magnum
Sparkling wine cooler for 2/3 bottles or Magnum
Seau à champagne 2/3 bouteilles ou Magnum
Champagnerkühler für 2/3 Flaschen oder Magnum
Cubo para refrescar 2/3 botellas de vino spumante
Ø cm.22,5 - H cm.23 - lt. 8,5
Ø 8⁷/₈" - H 9" - gal. 2¹/₄

680 mm.1,2

Rinfrescavino bianco da 1 bottiglia
White wine cooler for 1 bottle
Seau à vin blanc
Weissweinkühler für 1 Flasche
Cubo para refrescar 1 botella de vino blanco
Ø cm.18 - H cm.21 - lt. 4,5
Ø 7¹/₈" - H 8¹/₄" - gal. 1¹/₄



679 mm.1,2

Rinfrescavino bianco da 1 bottiglia
White wine cooler for 1 bottle
Seau à vin blanc
Weissweinkühler für 1 Flasche
Cubo para refrescar 1 botella de vino blanco
Ø cm.16 - H cm.20 - lt. 3
Ø 6¹/₄" - H 7⁷/₈" - oz. 101¹/₂



678

678 mm.1,2

Secchiello per ghiaccio
Ice bucket with grill
Seau à glaçons
Eisgefäß
Cubitera hielo
Ø cm.14 - H cm.13 - cl. 150
Ø 5¹/₂" - H 5¹/₈" - oz. 50³/₄

672



mm. 1,2

Portaghiaccio termico con anello e molla
Insulated ice-bucket with handle and tongs for ice
Seau à glaçon thermique avec anse et pinçe
Isolier-Eisgefäß und Eiszange
Cubitera hielo con asa y pinzas hielo

lt. 3/4 oz. 25³/₈

666A

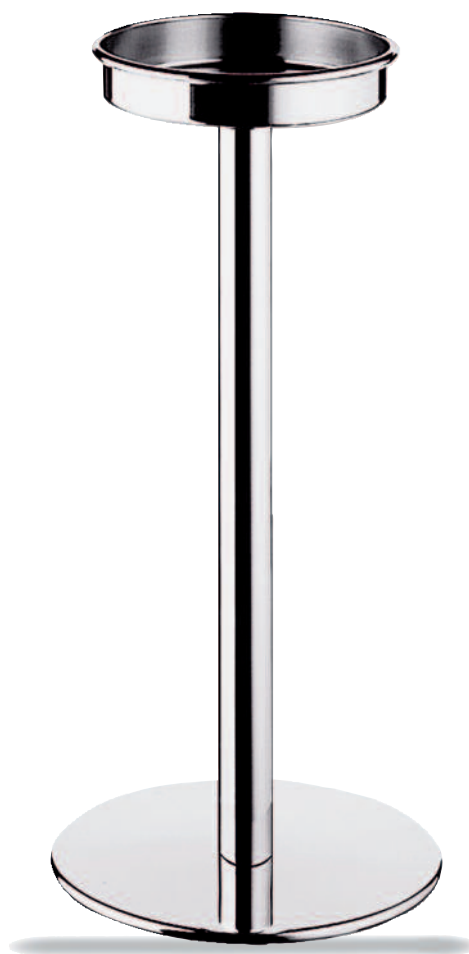

mm. 1,2

GALA
Colonna portasecchiello spumante
Wine cooler stand
Pied pour seau à champagne
Weinkühlerständer
Columna porta cubo champany

H cm. 60

H 23⁵/₈"

660



mm. 0,8

Servizio per champagne
Insulated Champagne set
Service pour champagne
Champagnergetränk cooler
Servicio para champagne

Ø cm. 26
H cm. 22
cl. 150

Ø 10¹/₄"
H 8²/₃"
oz. 50³/₄

67301



67304

669



668

mm. 1,2

GIOTTO
Portaghiaccio termico con coperchio
Insulated ice-bucket with lid
Seau à glaçons thermique
avec couvercle
Isolier-Eisgefäß
Cubitera hielo con tapa

Ø cm 14 H cm 13
cl.72

Ø cm 24 H cm 22
lt. 4,0

Ø 5 1/2" H 5"
oz. 24 1/3

mm. 1,2

GIOTTO
Secchiello spumante e ghiaccio
Sparkling wine cooler / Ice bucket
Seau à champagne et à glaçons
Wein- Sektkühler / Eisgefäß
Cubo para champany y para hielo

Ø cm 24 H cm 23
lt. 5,0

Ø cm 14,5 H cm 13
lt. 1,4

Ø 9 1/2" H 9"
gal. 1 1/3

Ø 5 2/3" H 5 1/8"
oz. 47 1/3

666E

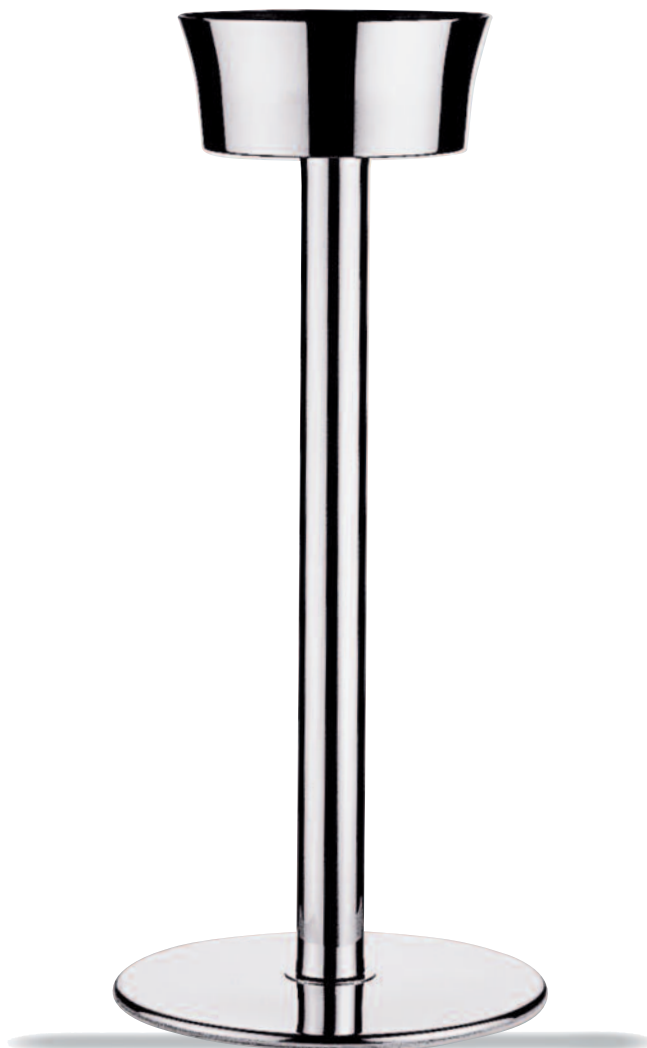

mm. 1,2

GIOTTO
Colonna portasecchiello spumante
Wine cooler stand
Pied pour seau à champagne
Weinkühlerständer
Columna porta cubo champany

H cm. 67,5 H 26 5/8"

370



mm. 1,2 | IMMAGINA
 Secchiello per spumante
 Sparkling wine cooler
 Seau à champagne
 Wein- und Sektkühler
 Cubo para champany

cm 27 x 20,5 | 10 5/8" x 8"
 H cm 21,5 | H 8 1/2"
 lt. 6,5 | gal. 1 3/4

371



mm. 1,2 | IMMAGINA
 Secchiello per ghiaccio
 Ice bucket
 Seau à glaçons
 Eisgefäß
 Cubitera para hielo

cm 16,6 x 10 | 6 1/2" x 4"
 H cm 14,2 | H 8 1/2"
 cl. 180 | oz. 60 7/8

666H



mm. 1,2 | IMMAGINA
 Colonna portasecchiello spumante
 Wine cooler stand
 Pied pour seau à champagne
 Weinkühlerständer
 Columna porta cubo champany

H cm. 61,5 | H 24 1/5"

597



mm. 1,2	UNO Secchiello per ghiaccio Ice bucket Seau à glaçons Eisgefäß Cubitera hielo	Ø cm. 16,8 H cm. 11 cl. 150	Ø 6 5/8" H 4 3/8" oz. 50 3/4
---------	--	-----------------------------------	------------------------------------

598



mm. 1,2	UNO Secchiello per spumante Sparkling wine cooler Seau à champagne Wein- und Sektkühler Cubo para champany	Ø cm. 29 H cm. 18,5 lt. 8	Ø 11 3/8" H 7 1/4" gal. 2
---------	---	---------------------------------	---------------------------------

666W

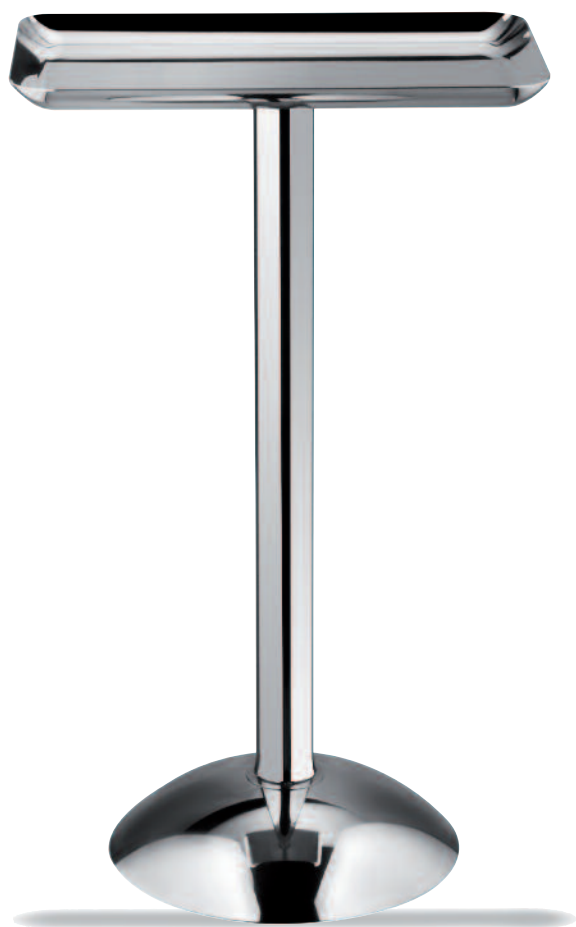

mm. 1,2	Gueridon d'appoggio rettangolare Rectangular gueridon But de canapé rectangulaire Gueridon, rechteckig Gueridon rectangular	H cm. 62 cm. 38 x 25	H 24 2/5" 15" x 9 7/8"
---------	---	-------------------------	---------------------------

666Z



mm. 1,2	Gueridon d'appoggio ovale Oval gueridon But de canapé oval Gueridon, oval Gueridon oval	H cm. 62 cm. 46 x 31	H 24 2/5" 18 1/8" x 12 1/4"
---------	---	-------------------------	--------------------------------

599



mm. 1,2 UNO
Secchiello per spumante
Sparkling wine cooler
Seau à champagne
Wein- und Sektkühler
Cubo para champany

Ø cm. 29 Ø 11 3/8"
H cm. 18,5 H 7 1/4"
lt. 8 gal. 2

596



mm. 1,2 Secchiello per ghiaccio
Ice bucket
Seau à glaçons
Eisgefäß
Cubitera hielo

Ø cm. 16,8 Ø 6 5/8"
H cm. 11 H 4 3/8"
cl. 150 oz. 50 3/4

599

58928

12 colori disponibili - pag. 253
12 colors available - page 253
12 couleurs disponibles - pag. 253
12 verschiedenen Farben verfügbar - Seite 253
12 colores disponibles - pag. 253

589 - Ø cm. 28
Ø 11"



mm. 1,2 UNO
Cestino traforato
Fretworked basket
Corbeille, ajourée
Früchtekorb gelocht
Cesta perforada

Ø cm. 29 Ø 11 3/8"
H cm. 18,5 H 7 1/4"
lt. 8 gal. 2

666C



mm. 1,2 UNO
Colonna portasecchiello spumante
Wine cooler stand
Pied pour seau à champagne
Weinkühlerständer
Columna porta cubo champany

H cm. 67,5 H 26 5/8"



598

59870

Logo traforato a richiesta
 Fretworked logo on demand
 Logo ajourée sur demande
 Firmenzeichen gelocht auf Verlangen
 Logo perforado en demanda

589 - Ø cm. 64
 Ø 25 1/4"

589 - Ø cm. 28
 Ø 11"



598	
mm. 1,2	Secchiello Basket Corbeille Früchtekorb Cesta
Ø cm. 29 H cm. 18,5 lt. 8	Ø 11 3/8" H 7 1/4" gal. 2

59870	
mm. 1,2	Big Champagnera Champagne bowl Bol a champagne Champagner Bowl Cesta para champany
Ø cm. 67,5 H cm. 43 lt. 80	Ø 26 5/8" H 17" gal. 21

A



Ambra
Amber
Amber
Amber
Ambar



G



Granato
Garnet
Grenat
Granat
Granate

Q



Quarzo
Quartz
Quartz
Quarz
Cuarzo

M



Ametista
Amethyst
Amethyste
Amethyst
Amatista

W



Trasparente
Transparent
Glace
Transparent
Vidrio

Z



Zaffiro
Sapphyre
Saphir
Saphir
Zafiro

S



Smeraldo
Emerald
Emeraude
Smaragd
Esmeralda

V



Olivina
Olivine
Olivine
Olivia
Olivino

B



Berillo
Beryll
Beryl
Beryl
Berilo

O



Onice
Onyx
Onyx
Onyx
Onice

909



mm. 1,2 | Secchiello per ghiaccio forato
Ice bucket fretworked handles
Seau à glaçons anses ajourée
Eisgefäß mit Griffen
Cubitera hielo asa perforada

cm. 22 x 20 | 8³/₄" x 7⁷/₈"
H cm. 11,5 | H 4 5⁵/₈"
lt. 1,2 | oz. 40 1¹/₂

912



mm. 1,2 | Secchiello per spumante forato
Sparkling wine cooler fretw.handles
Seau à champagne anses ajourée
Wein- und Sektkühler mit Griffen
Cubo para champany asa perforada

cm. 39 x 36 | 15³/₈" x 14¹/₄"
H cm. 17,5 | H 7"
lt. 7 | gal. 1 4⁴/₅

730



mm. 1,2 | Spumantiera 12 bottiglie champagne
Giant champagne bucket for 12 bottles
Seau à champagne géante pour 12 bouteilles
Champagner Bowl für 12 Flaschen
Cubo de champagne gigante para 12 botellas

cm. 75 x 65 | 29 1¹/₂" x 25 5⁵/₈"
H cm. 19 | H 7 1¹/₂"
lt. 15 | gal. 3 7⁷/₈

899



mm. 1,2 | Secchiello per ghiaccio
Ice bucket
Seau à glaçons
Eisgefäß
Cubitera hielo

cm. 22 x 20 | 8³/₄" x 7⁷/₈"
H cm. 11,5 | H 4 5⁵/₈"
lt. 1,2 | oz. 40 1¹/₂

910



mm. 1,2 | Secchiello per spumante
Sparkling wine cooler
Seau à champagne
Wein- und Sektkühler
Cubo para champany

cm. 39 x 36 | 15³/₈" x 14¹/₄"
H cm. 17,5 | H 7"
lt. 7 | gal. 1 4⁴/₅

658

N E W



Cubetto luminoso confez. 72 pezzi LED ice cube 72 pcs. box Glaçons lumineux 72 pièces Eiswürfel LED 72 Stücke Cubito hielo LED 72 piezas	cm. 2,5 x 2,5 H cm. 2,5	1" x 1" H 1"
--	----------------------------	-----------------

Idoneo al contatto con gli alimenti.

Suitable for contact with food

Apte au contact alimentaire.

Materiale certificato:
LFGB - German Food,
Commodities and Animal Feed Code
of Law
DIN 10955 - 2004
ISO 11885:2007
BfR Recommendations on
Food Contact Materials - part V & VI
2010 & 2010
Regolamento CEE (EU) 10/2011
Regolamento CEE (EC) 1907/2006
Regolamento CEE (EC) 1935/2004

Certified material:
LFGB - German Food,
Commodities and Animal Feed Code
of Law
DIN 10955 - 2004
ISO 11885:2007
BfR Recommendations on
Food Contact Materials - part V & VI
2010 & 2010
Regulation CEE (EU) 10/2011
Regulation CEE (EC) 1907/2006
Regulation CEE (EC) 1935/2004

Matériel certifié:
LFGB - German Food,
Commodities and Animal Feed Code
of Law
DIN 10955 - 2004
ISO 11885:2007
BfR Recommendations on
Food Contact Materials - part V & VI
2010 & 2010
Réglementation CEE (EU) 10/2011
Réglementation CEE (EC) 1907/2006
Réglementation CEE (EC) 1935/2004

Durata delle batterie: 12 ore

Battery life: 12 hours

Vie de la batterie: 12 heures

Geeignet für Lebensmittel Kontakt.

Apto para el contacto con alimentos .

Zertifiziertes Material:
LFGB - German Food,
Commodities and Animal Feed Code
of Law
DIN 10955 - 2004
ISO 11885:2007
BfR Recommendations on
Food Contact Materials - part V & VI
2010 & 2010
Verordnung EWG (EU) 10/2011
Verordnung EWG (EC) 1907/2006
Verordnung EWG (EC) 1935/2004

Material certificado:
LFGB - German Food,
Commodities and Animal Feed Code
of Law
DIN 10955 - 2004
ISO 11885:2007
BfR Recommendations on
Food Contact Materials - part V & VI
2010 & 2010
Reglamento CEE (EU) 10/2011
Reglamento CEE (EC) 1907/2006
Reglamento CEE (EC) 1935/2004

Akkus Lebensdauer: 12 Stunden

Duración de la batería: 12 horas



SPECIAL FINISHING

609B



mm. 1,2	Piano	cm. 40 x 36	15 3/4" x 14 1/8"
	Tray Plateau Tablett oval Bandeja		

612B



mm. 1,2	Piano forato	cm. 40 x 36	15 3/4" x 14 1/8"
	Tray fretworked handles Plateau avec anses ajourée Grifftablett oval Bandeja asa perforada		

613B



mm. 1,2	Fondo	cm. 22 x 20	8 5/8" x 7 7/8"
	Bowl		
	Bol	cm. 40 x 36	15 3/4" x 14 1/8"
	Obtschale oval Cuenco		

614B

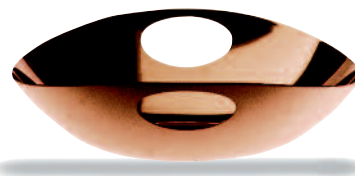

mm. 1,2	Fondo forato	cm. 22 x 20	8 5/8" x 7 7/8"
	Bowl fretworked handles		
	Bol avec anses ajourée	cm. 40 x 36	15 3/4" x 14 1/8"
	Griffschale oval Cuenco asa perforada		

617B



mm. 1,2	Sottopiatto ovale	cm. 34 x 31	13 3/8" x 12 1/4"
	Charger oval Assiette de bienvenue ovale Platzteller oval Bajo plato oval		

630B



mm. 1,2	Antipastiera	cm. 34 x 31	13 3/8" x 12 1/4"
	Hors d'oeuvre tray Plat à hors d'oeuvre Vorspeisenplatte Entremesera		

616B



mm. 1,2	Formaggera Parmesan cheese basin Fromagère Käsedose Quesera Azucarero	cm. 14 x 12 cl. 20	5 1/2" x 4 3/4" oz. 6 3/4
---------	---	-----------------------	------------------------------

615B



mm. 1,2	Completo oliera e spargisale Cruet and salt cellar set Service huile-vinaigre Essig-/Ölgestell 4-tlg. Convoy vinagreras y saleros	cm. 22x20 H cm. 19,6 cl. 30 (x2) cl. 8 (x2)	8 5/8" x 7 7/8" H 7 3/4" oz. 10 1/8 (x2) oz. 2 3/4 (x2)
---------	---	--	--

627B



mm. 1,2	Piano milleusi Multifunction tray Plateau oval multi usages Tablett mit Brett und 3 Porzellan Sossenschalen Bandeja oval multi usos	cm. 40 x 36	15 3/4" x 14 1/8"
---------	--	-------------	-------------------

350



352

Ampolla Cruet Huilliere Öl-/Essigflasche Vinagrera	H cm. 18 cl. 30 H 7 1/8" oz. 10 1/8	Salino Salt cellar Cristal pour sel et poivre Salz-Pfefferstreuer Salero	H cm. 8 cl. 8 H 3 1/8" oz. 2 3/4
--	--	---	---

616BAC



mm. 1,2	Piattino per pane Bread tray Plat pour pan Brot Platte Plato para pan	cm. 14 x 12	5 1/2" x 4 3/4"
---------	---	-------------	-----------------

61739B



mm. 1,2	Sottopiatto ovale magnum Charger oval Assiette de bienvenue ovale Platzteller oval Bajo plato oval	cm. 39 x 36	15 3/8" x 14 1/8"
---------	--	-------------	-------------------

SPECIAL FINISHING

910B



mm. 1,2 | Secchiello per spumante
Sparkling wine cooler
Seau à champagne
Wein- und Sektkühler
Cubo para champany

cm. 39 x 36	15 ³ / ₈ " x 14 ¹ / ₄ "
H cm. 17,5	H 7"
lt. 7	gal. 1 ⁴ / ₅

899B



mm. 1,2 | Secchiello per ghiaccio
Ice bucket
Seau à glaçons
Eisgefäß
Cubitera hielo

cm. 22 x 20	8 ³ / ₄ " x 7 ⁷ / ₈ "
H cm. 11,5	H 4 ⁵ / ₈ "
lt. 1,6	oz. 54

912B

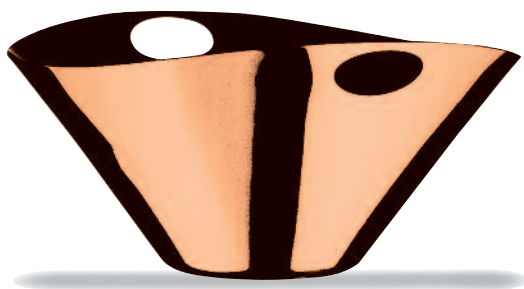

mm. 1,2 | Secchiello per spumante forato
Sparkling wine cooler fretworked handles
Seau à champagne anses ajourée
Wein- und Sektkühler mit Griffen
Cubo para champany asa perforada

cm. 39 x 36	15 ³ / ₈ " x 14 ¹ / ₄ "
H cm. 17,5	H 7"
lt. 6	gal. 1 ³ / ₅

909B

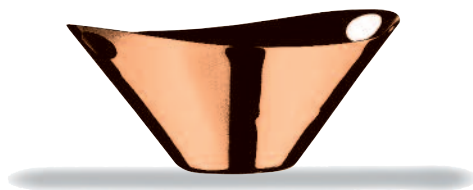

mm. 1,2 | Secchiello per ghiaccio forato
Ice bucket fretworked handles
Seau à glaçons anses ajourée
Eisgefäß mit Griffen
Cubitera hielo asa perforada

cm. 22 x 20	8 ³ / ₄ " x 7 ⁷ / ₈ "
H cm. 11,5	H 4 ⁵ / ₈ "
lt. 1,2	oz. 40 ¹ / ₂

ACCIAIO

p. 231



609	612
613	614
617	630

p. 232

616	615
627	
616AC	61739

p. 233

910	899
912	909

ICE ORO

p. 231



	101
	102
110	106

p. 232

105	104
113	
117	11039

p. 233

120	118
121	119

ORO NERO

p. 231



	101N
	102N
110N	106N

p. 232

105N	104N
113N	
117N	11039N

p. 233

120N	118N
121N	119N

BRONZO

p. 231

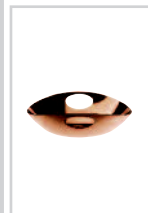

609B	612B
613B	614B
617B	630B

p. 232

616B	615B
627B	
616 BAC	61739B

p. 233

910B	899B
912B	909B



1001



mm. 1,2	Piano forato Tray fretworked handles Plateau avec anses ajourée Griffblett oval Bandeja asa perforada	cm. 40 x 36	15 3/4" x 14 1/8"
---------	---	-------------	-------------------

1002



mm. 1,2	Cestino/Portafrutta Bowl/Fruit holder Bol/Compotier Griffschale/Obstschale Cuenco/Fruterо	cm. 22 x 20 cl. 100	8 5/8" x 7 7/8" oz. 33 7/8
		cm. 40 x 36 cl. 200	15 3/4" x 14 1/8" oz. 67 5/8

1003



mm. 1,2	Sottopiatto Charger Assiette de bienvenue Platzteller Bajo plato	cm. 34 x 31	13 3/8" x 12 1/4"
---------	--	-------------	-------------------

1004



mm. 1,2	Sottobottiglia Bottle coaster Dessous de bouteille Flaschenteller Posabotella	cm. 14 x 12	5 1/2" x 4 3/4"
---------	---	-------------	-----------------

1005

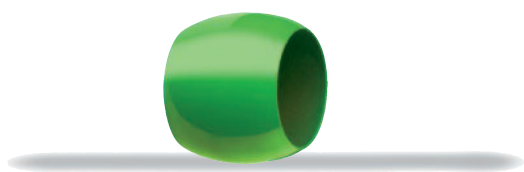

mm. 1,2	Allacciatovaglioli Napkins ring Rond de serviette Serviettenring Servilletero	Ø cm. 6	Ø 2 3/8"
---------	---	---------	----------

SPECIAL FINISHING

1010



mm. 1,2	Centrotavola grande Big Centerpiece Grand Centre de table Grosse Tafelaufsatz Centro de mesa grande	cm. 39 x 36 H cm. 17,5 lt. 6	15 ³ / ₈ " x 14 ¹ / ₄ " H 7" gal. 1 ³ / ₅
---------	---	------------------------------------	---

1009



mm. 1,2	Centrotavola piccolo Small Centerpiece Petit Centre de table Kleine Tafelaufsatz Centro de mesa pequeño	cm. 22 x 20 H cm. 11,5 lt. 1,2	8 ³ / ₄ " x 7 ⁷ / ₈ " H 4 ⁵ / ₈ " oz. 40 ¹ / ₂
---------	---	--------------------------------------	--

1006



mm. 1,2	Completo oliera e spargisale Cruet and salt cellar set Service huile-vinaigre Essig-/Ölgestell 4-tlg. Convoy vinagreras y saleros	cm. 22x20 H cm. 19,6 cl. 30 (x2) cl. 8 (x2)	8 ⁵ / ₈ " x 7 ⁷ / ₈ " H 7 ³ / ₄ " oz. 10 ¹ / ₈ (x2) oz. 2 ³ / ₄ (x2)
---------	---	--	---

1007



mm. 1,2	Formaggera Parmesan cheese basin Fromagère Käsedose Quesera Azucarero	cm. 14 x 12 cl. 20	5 ¹ / ₂ " x 4 ³ / ₄ " oz. 6 ³ / ₄
---------	---	-----------------------	--

1008



mm. 1,2	Antipastiera Hors d'oeuvre tray Plat à hors d'oeuvre Vorspeisenplatte Entremesera	cm. 34 x 31	13 ³ / ₈ " x 12 ¹ / ₄ "
---------	---	-------------	---



J Girasole
Sunflower
Tournesol
Sonnengelb
Girasol



F7 Carota
Carrot
Carotte
Mohrrübe
Zanahoria



S7 Rosso
Red
Rouge
Signalrot
Rojo



A7 Mela verde
Apple green
Vert pomme
Apfelgrün
Verde Manzana



V7 Viola
Violet
Violet
Pflaume
Violeta



C Cobalto
Cobalt
Cobalt
Kobalt
Cobalto

Acciaio verniciato con resina epossidica
Epoxy resin-coated steel
Acier recouvert de époxy-résine
Stahl mit Epoxy-Lackierung
Acero con recubrimiento epoxi



Possibilità di abbinare le posate FANTASIA a pagina 256, nelle stesse tonalità
You can couple the cutlery FANTASIA of page 256, matching the same color tonality of this collection.

Vous pouvez coupler les couverts FANTASIA à la page 256, correspondant le même couleur de cette collection.

Die Farbtöne des Bestecks Fantasia (Seite 256) lassen sich mit den Farbtönen dieser Kollektion kombinieren.

Se puede acoplar los cubiertos FANTASIA en la página 256, igualando el mismo color de esta colección.



Induction



- Prodotti High Tech.
- Efficienza energetica 100%.
- Ottimizzano le rese delle cucine professionali ad induzione più performanti.
- Altissimo spessore.
- Possibili finiture e loghi personalizzati.
- Non solo da nascondere in cucina, ma per il servizio al tavolo.

- High Tech products.
- 100% energy efficiency.
- Performance optimization of industrial kitchens at the highest level.
- Highest thickness.
- Possible to customize with personal logos and finishings.
- Suitable not only for the kitchen, but also for serving.

- Technologie de haute qualité.
- 100 % efficacité calorifique.
- Optimise les performances de cuisson au plus haut niveau.
- Fabrication forte épaisseur
- Il est possible de personnaliser et de faire des finitions spéciales.
- Ce type de matériel convient aussi en bien en cuisson en cuisine, qu'au service à table.

- Hightech Produkte.
- 100% Energieeffizient.
- Damit heben Sie Leistung & Effizienz Ihrer Profi-Küchen auf die höchste Stufe.
- Größtmögliche Materialstärken.
- Verschiedene Logoapplikationen und Finishings sind jederzeit möglich.
- Sowohl für den Einsatz im Küchen-, als auch im Servicebereich geeignet.

- Productos de alta tecnología.
- 100% Eficiencia energética.
- Optimiza el rendimiento de las cocinas de inducción profesional al más alto nivel.
- Gran espesor.
- Es posible aplicar logotipos personales y acabados especiales.
- No solo para esconderse en la cocina, sorprende en el servicio directo de mesa.





1821+1851

Tutte le pentole sono spedite con coperchio
All the pots are delivered with lid
Tous les marmites sont livrés avec le couvercle
Alle Töpfe werden mit Deckel geliefert
Todas las ollas son entregados con la tapa

1811+1851



	Ø cm.	Litri	Ø in.	Oz.
Mini casseruola 2 manici NON per piastre ad induzione NO INDUCTION mini casserole 2 handles Mini faitoute 2 man.NON pour induction Mini Bratentopf 2 Grif. NICHT für Induktion Mini cacerola 2 man. NO para la inducción	12	0,6	3 1/2" 4 7/8"	8 1/2 20 1/4

	Ø cm.	Litri	Ø in.	Oz.
Mini casseruola 1 manico NON per piastre ad induzione NO INDUCTION mini casserole 1 handle Mini faitoute 1 man.NON pour induction Mini Bratentopf 1 Griff NICHT für Induktion Mini cacerola 1 man. NO para la inducción	9	0,25	3 1/2"	8 1/2

1801+1851



1821+1851



	Ø cm.	Litri	Ø in.	Qt.
Pentola alta Deep pot Marmite Gemüsetopf Olla alta	24 22 20	6,5 5,0 3,5	9 1/2" 8 2/3" 7 7/8"	6 1/3 5 2/7 3 1/4

	Ø cm.	Litri	Ø in.	Qt.
Casseruola fonda 2 manici Deep casserole 2 handles Faitout 2 manches Bratentopf 2 Griffen Cacerola honda 2 mangos	24 22 20 18	5,0 3,5 3,0 2,0	9 1/2" 8 2/3" 7 7/8" 7"	5 2/7 3 1/4 3 1/6 2 1/9

1841-1851

1831+1851

1811+1851

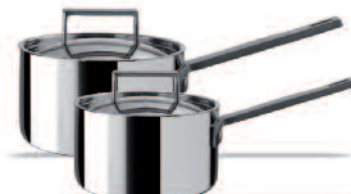

	Ø cm.	Litri	Ø in.	Qt.
Padella 1 manico Frying pan Poêle a frire Bratpfanne Sartén	26	3,0	10 1/4"	3 1/8

	Ø cm.	Litri	Ø in.	Qt.
Tegame 2 manici Frying pan 2 handles Sauteuse 2 manches Bratpfanne 2 Griffen Rustidera 2 mangos	28 24	4,0 3,0	11" 9 1/2"	4 1/4 3 1/8

	Ø cm.	Litri	Ø in.	Qt.
Casseruola 1 m. Casserole 1 h. Faitout 1 man. Stielkasserolle Cacerola 1 m.	16 14	2,0 1,0	6 1/4" 5 1/2"	2 1/3 1



2179

2179



Padella
Frying pan
Poêle a frire
Bratpfanne
Sartén

Ø cm.	Ø in.
28	11"
24	9 1/2"
20	7 7/8"

2131 + 2151

2121+2151

2101+2151



Tegame con coperchio
Frying pan with lid
Sauteuse avec couvercle
Bratpfanne mit Deckel
Rustidera con tapa

Ø cm.	Litri	Ø in.	Qt.
32	5,0	10 1/4"	2 1/2
26	2,7		



Pentola con coperchio
Deep pot with lid
Marmite avec couvercle
Gemüsetopf mit Deckel
Olla alta con tapa

Ø cm.	Litri	Ø in.	Qt.
22	6,4	8 2/3"	5 7/8

Ø cm. - Litri Ø in. Qt.

Casseruola con coperchio	22	5,0	8 2/3"	5 2/7
Deep casserole with lid	20	3,5	7 7/8"	3 1/4
Faitout avec couvercle				
Bratentopf mit Deckel				
Cacerola honda con tapa				

2111+2151

2178-2151

2180



Casseruola 1 m. c/coperchio
Casserole 1 h. w/lid
Faitout 1 man. a/couvercle
Stielkasserolle m/Deckel
Cacerola 1 m. c/tapa

Ø cm.	Litri	Ø in.	Qt.
16	1,4	6 1/4"	1 1/4



	Ø cm.	Litri	Ø in.	Qt.
Wok	28	3,0	11"	3 1/8



Bistecchiera
Grill pan
Gril
Grill Pfanne
Bistequera

cm.	in.
28 x 28	11" x 11"



Casseruola ovale c/coperchio
Oval deep casserole w/lid
Cocotte ovale a/couvercle
Kasserolle, oval m/ Deckel
Cazuela oval con tapa

cm.	Litri	in.	Qt.
30 x 24 H 11	5,1	11 4/5"x 9 1/2" H 4 1/3"	5 3/7

2162+2151

Spa & Wellness



- Infrangibile
- Adatto alla lavastoviglie
- Adatto al forno a microonde
- Ideale per:
- Discoteche
- Yacht e navi da crociera
- Cliniche
- Case di riposo per anziani
- Asili

Ideale per tutti i luoghi dove i clienti possono accedere a piedi nudi:

- Piscine
- Spiagge
- Prati
- Centri di benessere
- Impianti sportivi
- Tonalità diverse disponibili a richiesta
- Possono essere personalizzati con logo, anche a più colori

- Unbreakable
- Dishwasher Safe
- Microwave Safe
- Ideale for:
- Night Clubs
- Yachts and Cruise Ships
- Hospitals and Medical
- Clinics
- Rest Homes
- Schools
- Perfect for Barefoot

- Environments:
- Swimming Pools
- Beaches
- Lawns
- Wellness Centers
- Fitness Centers
- Available in additional colors.
- Imprinting and logos available. Multicolor printing available.

- Incassable
- Utilisable au laves-vaisselles
- Utilisable au Four à micro-ondes
- Idéal pour :
- Discothèques
- Yacht et bateaux de croisière
- Cliniques
- Maisons de repos
- Crèches

Ideal pour tous les lieux où les clients peuvent accéder à pied nus :

- Piscines
- Plages
- Jardin
- Centre de bien-être

- Installations sportives
- Tonalités différentes disponibles sur demande
Ils peuvent être personnalisés avec logo, multicouleurs, gravées ou lazer

- Unzerbrechlich
- Spülmaschinenfest
- Microwellenfest
- Daher bestens geeignet zum Gebrauch:
- in Cocktailbars & Night Clubs
- für Yachten und Kreuzfahrtschiffe
- in Kliniken und Heimen
- in Badezimmern
- für Schulen und Kindergärten

Auch aufgrund der Bruchsicherheit perfekt einzusetzen an Orten, die barfuß betreten werden:

- Schwimmbäder und Poolbereiche
- Strände und Strandbars
- Rasenflächen
- Wellnesscenter
- Fitnesscenter
- Alle Produkte sind auch in zusätzlichen, weiteren Farben erhältlich.
- Alle Produkte können auch mit Logos und Beschriftung individualisiert werden.
- Dabei ist auch mehrfarbiger Druck möglich.

- Irrompible
- Apto para lavavajillas
- Apto para microondas
- Ideal para:
- Discotecas
- Yates y barcos de crucero
- Clinicas
- Residencias de ancianos
- Asilos
- Ideal para todos los lugares donde los clientes pueden ir descalzos:
- Piscinas
- Playas
- Praderas
- Centros de bienestar
- Centros deportivos
- Tonos diversos disponibles por encargo
- Se pueden personalizar con logo, incluso en varios colores.



22004



Articolo venduto in posto tavola
Sold as a 4pcs Place setting only
Vendu comme un set de table 4 pièces
Verkauf als Komplett-Set
Se vende el juego 4 piezas

588



Bicchiere
Glass
Gobelet
Glas
Vaso

H cm 10
cl. 33

H 3⁷/₈"
oz. 11 1/8

591



Bicchiere
Glass
Gobelet
Glas
Vaso

H cm 13
cl. 45

H 5"
oz 15 1/4

554



Fondo
Bowl
Bol
Obstschale oval
Cuenco

Ø cm. 18 | Ø 7"

553

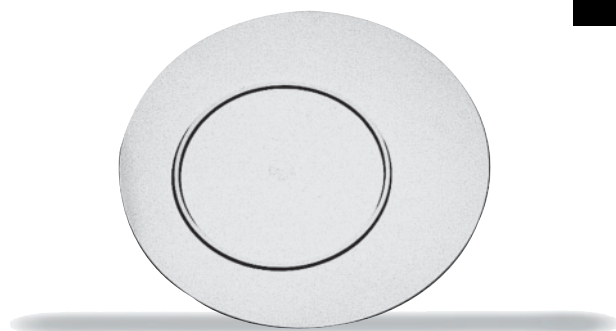

Piano
Tray
Plateau
Tablett oval
Bandeja

Ø cm. 27 | Ø 10 1/2"

555



Piano per buffet
Tray for buffet
Plateau pour buffet
Buffettablett
Bandeja para buffet

Ø cm. 27 | Ø 10 1/2"

589



Ciotola tonda
Round bowl
Bol ronde
Früchtekorb, rund
Cuenco redondo

Ø cm. 12	Ø 4 3/4"
H cm. 7,4	H 2 7/8"
cl. 40	oz. 13 1/2

605



Set impilabile di 3 coppette tonde
Stackable set of 3 round bowls
Set empilable de 3 bols ronde
Stapelbarer Relish-Pickles-Gestell , rund
Set impilable de 3 cuencos redondos

cl. 40 (x 3)	oz. 13 1/2 (x 3)
--------------	------------------

589



Ciotola tonda
Round bowl
Bol ronde
Früchtekorb rund
Cuenco redondo

Ø cm. 22	Ø 8 1/2"
H cm. 14	H 5 1/2"
cl. 220	oz. 74 3/8

589+599



589



Ciotola tonda
Round bowl
Bol ronde
Früchtekorb rund
Cuenco redondo

Ø cm. 28	Ø 11"
H cm. 17,3	H 6 5/8"
lt. 6,03	oz. 202 1/2

550



Mug

H cm 10 cl. 33	H 3 7/8" oz. 11 1/8
-------------------	------------------------

552



Piattino per mug e bicchieri (Art. 550,588,591) Mug coaster (Art. 550,588,591) Dessous de verre (Art. 550,588,591) Gläseruntersatz (Art. 550,588,591) Posavasos por mug (Art. 550,588,591)	Ø cm. 13,2	Ø 5 1/4"
--	------------	----------

592



Tazzina da caffè con piattino
Express coffee cup and saucer
Tasse de moka avec soucoupe
Mokka Tasse mit Untertasse
Taza de moka con platillo

cl 9	oz. 3
------	-------

593



Tazza da tè con piattino
Tea cup and saucer
Tasse de thé avec soucoupe
Tee Tasse mit Untertasse
Taza de tè con platillo

cl 15	oz 5 1/8
-------	----------

590



Ciotola quadra
Square bowl
Bol carrè
Obstschale viereckig
Cuenco cuadrado

cm. 10 x 10 cl. 27	3 7/8" x 3 7/8" oz. 9 1/8
-----------------------	------------------------------

606



Set impilabile di 3 coppette quadre
Stackable set of 3 square bowls
Set empilable de 3 bols carrè
Stapelbarer Relish-Pickles-Gestell ,
quadratisch
Set impilable de 3 cuencos cuadrados

cl. 27 (x 3)	oz. 9 1/8 (x 3)
--------------	-----------------

542



Vassoio rettangolare
Rectangular tray
Plateau rectangulaire
Tablett rechteckig
Bandeja rectangular

cm. 24,5 x 18,5 | 9 3/4" x 7 3/8"
H cm. 3 | H 1 1/4"

538



Ciotola rettangolare
Rectangular bowl
Bol rectangulaire
Obtschale rechteckig
Cuenco rectangular

cm. 24,5 x 18,5 | 9 3/4" x 7 3/8"
H cm. 8,5 | H 3 3/8"

600



Caraffa per bibita
Jug for drinks
Carafe
Saftkrug
Jarra agua

lt. 1 | oz. 33 7/8

556



Paia posate per insalata
Salad serving set
Couverts à servir la salade
Salatvorlege Service 2-Tlg.
Cubiertos para ensalada 2 pzas.

Lung. cm. 27
Long. 10 5/8"

536



Coppa per gelato
Ice cream cup
Coupe à glaçe
Eisbecher
Copa helado

H cm 12 cl. 27	H 4 3/4" oz 9 1/8
-------------------	----------------------

535



Coppa Martini
Martini glass
Coupe à Martini
Martini glas
Vaso para Martini

H cm. 19 cl 27	H 7 1/2" oz 9 1/8
-------------------	----------------------

534



Bicchiere per birra
Beer glass
Gobelet pour birre
Bierbecher
Vaso para cerveza

H cm. 17,5 cl 45	H 6 7/8" oz 15 1/8
---------------------	-----------------------

533



Bicchiere per vino
Beverage glass
Gobelet pour vin
Weinbecher
Vaso para vino

H cm. 24,5 cl 45	H 9 1/3" oz 15 1/8
---------------------	-----------------------

527

NEW



Bicchiere da whisky
Whisky glass
Gobelet pour whisky
Whisky Becher
Vaso para whisky

cl. 15 oz. 5 1/8

NEW

531



Bicchiere da liquore
Liquor glass
Gobelet pour alcool
Schnapsbecher
Vaso para alcohol

cl. 9 oz. 3

543



Bicchiere per champagne
Champagne glass
Gobelet pour champagne
Champagnerglas
Vaso para champany

H cm. 22,7 cl. 15	H 9" oz. 5 1/8
----------------------	-------------------





A Ambra
Amber
Ambre
Amber
Ambar



G Granato
Garnet
Grenat
Granat
Granate



Q Quarzo
Quartz
Quartz
Quarz
Cuarzo



S Smeraldo
Emerald
Émeraude
Smaragd
Esmeralda



V Olivina
Olivine
Olivine
Olivia
Olivino



Z Zaffiro
Sapphyre
Saphir
Saphir
Zaffiro

Tutti gli articoli da pagina 246 a pagina 251 sono disponibili in 12 colori

All the items from page 246 to page 251 are available in 12 colors,

Toutes les articles da page 246 à page 251 sont disponibles en 12 couleurs

Alle Polycarbonat-Produkte von Seite 246 bis zu Seite 251 sind in 12 Farben bzw. Ausführungen erhältlich

Todos los artículos da pagina 246 à pagina 251 son disponibles en 12 colores,



M Ametista
Amethyst
Amethyste
Amethyst
Amatista



W Trasparente
Transparent
Glace
Transparent
Vidrio



B Berillo
Beryl
Beryl
Beryl
Berilo



O Onice
Onyx
Onyx
Onyx
Onice



P Porcellana
White
Porcelain
Weiss
Porcelana



N Nero
Black
Noir
Schwarz
Negro

886



Secchiello per ghiaccio
Ice bucket
Seau à glaçons
Eisgefäß
Cubitera hielo

Ø cm. 15	Ø 5 7/8"
H cm. 15	H 5 7/8"
cl. 150	oz. 50 3/4

888



Secchiello per spumante
Sparkling wine cooler
Seau à vin/glace
Wein- und Sektkühler
Cubo para champany

Ø cm. 22	Ø 8 5/8"
H cm. 22	H 8 5/8"
lt. 5	gal. 1 1/4

891



Bicchiere
Glass
Gobelet
Glas
Vaso

H cm. 13	H 5"
cl. 33	11 1/8 oz

892



Bicchiere
Glass
Gobelet
Glas
Vaso

H cm. 10	H 4"
cl. 25	8 2/5 oz

517

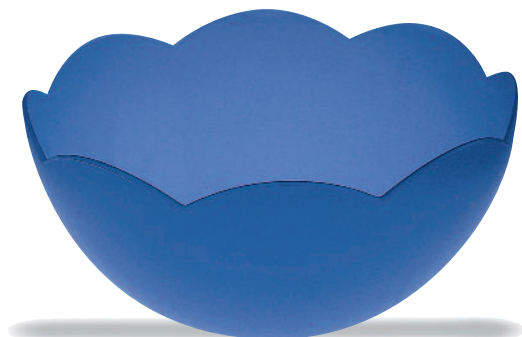

Ciotola
Bowl
Bol
Obstschale
Cuenco

Ø cm. 10	Ø 3 7/8"
cl. 30	oz. 10 1/8
Ø cm. 15	Ø 5 7/8"
cl. 60	oz. 20 1/4
Ø cm. 22	Ø 8 5/8"
cl. 200	oz. 67 5/8
Ø cm. 28	Ø 11"
lt 4	gal. 1

099



Sottopiatto
Charger
Assiette de bienvenue
Platzteller
Bajo plato

CARAMELLA	Ø cm. 32	Ø 12 5/8"
"		
"		
"		

093



W Ghiaccio
Ice
Glace
Eis
Hielo



O Arancio
Orange
Orange
Orange
Naranja



G Limone
Lemon
Jaune
Zitrone
Amarillo



E Verde acido
Acid green
Vert acide
Azid Grün
Pistacho



B Anice
Anis
Bleu
Blau
Azul



U Luce di Wood
Wood light
Lumière de Wood
Schwarzlicht
Luz de Wood

Solo art. 891 - 892
Only for art. 891 - 892
Seulement pour art. 891 - 892
Nur für Art. 891 - 892
Solo para art. 891 - 892

Tutti gli articoli di pagina 254 sono disponibili in 5 colori

All the items of page 254 are available in 5 colors

Toutes les articles de page 254 sont disponibles en 5 couleurs

Alle Produkte von Seite 254 sind in 5 Farben bzw. Ausführungen erhältlich

Todos los artículos de pagina 254 son disponibles en 5 colores

FANTASIA
MILLENNIUM



06

mm 3,0

01



Lunghezza 197 mm
Length 7 3/4"

Cucchiaino tavola
Table spoon
Cuillère table
Tafellöffel
Cuchara mesa

02



Lunghezza 197 mm
Length 7 3/4"

Forchetta tavola
Table fork
Fourchette table
Tafelgabel
Tenedor mesa

03



Lunghezza 223 mm
Length 8 3/4"

Coltello tavola
Table knife
Couteau table
Tafelmesser
Cuchillo mesa

04



Lunghezza 174 mm
Length 6 7/8"

Cucchiaino frutta
Fruit spoon
Cuillère dessert
Dessertlöffel
Cuchara postre

05



Lunghezza 175 mm
Length 6 8/9"

Forchetta frutta
Fruit fork
Fourchette dessert
Dessertgabel
Tenedor postre

06



Lunghezza 197 mm
Length 7 3/4"

Coltello frutta
Fruit knife
Couteau dessert
Dessertmesser
Cuchillo postre

07



Lunghezza 133 mm
Length 5 1/4"

Cucchiaino caffè
Tea spoon
Cuillère à café
Kaffelöffel
Cuchara café

10



Lunghezza 235 mm
Length 9 1/4"

Cucchiaino
Cooking spoon
Cuillère à légumes
Gemüselöffel
Cuchara legumbres

11



Lunghezza 235 mm
Length 9 1/4"

Forchettone
Cooking fork
Fourchette à légumes
Fleischgabel
Tenedor legumbres

15



Lunghezza 157 mm
Length 6 1/5"

Forchettina dolce
Cake fork
Fourchette à gateaux
Kuchengabel
Tenedor pastel

16

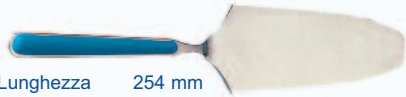

Lunghezza 254 mm
Length 10"

Pala per torta
Cake trowel
Pelle à tarte
Tortenheber
Pala tarta

20



Lunghezza 198 mm
Length 7 4/5"

Paletta pesce tavola
Table fish knife
Couteau poisson
Fischmesser
Pala pescado

21



Lunghezza 195 mm
Length 7 2/3"

Forchetta pesce tavola
Table fish fork
Fourchette poisson
Fischgabel
Tenedor pescado

22



Lunghezza 233 mm
Length 9 1/6"

Cucchiaino insalata a servire
Salad spoon
Cuillère à salade
Salatvorlegelöffel
Cuchara ensalada

23



Lunghezza 233 mm
Length 9 1/6"

Forchetta insalata a servire - Salad fork
Fourchette à salade
Salatvorlegelgabel
Tenedor ensalada

40



Lunghezza 185 mm
Length 7 1/4"

Mestolino salsa
Ladle sauce
Cuillère à sauce
Saucenlöffel
Cacillo salsa

42



Lunghezza 290 mm
Length 11 2/5"

Forchetta per fonduta
Fondue fork
Fourchette à fondue
Fonduegabel
Tenedor para fondue

43



Lunghezza 277 mm
Length 10 8/9"

Cucchiaino risotto
Vegetable spoon
Cuillère à "risotto"
Gemüselöffel
Cuchara para arroz seco

COLORI DISPONIBILI
 AVAILABLE COLORS
 COULEURS DISPONIBLES
 VERFÜGBARE FARBEN
 COLORES DISPONIBLES

N

Nero
 Black
 Noir
 Schwarz
 Negro



I

Vigogna
 Vicuna
 Vigogne
 Grau
 Vicuña



S

Salvia
 Sage
 Sauge
 Salbei
 Salvia



W

Porcellana
 China
 Porcelaine
 Porzellan
 Porcelana



P

Wengé



I7

Cioccolato
 Chocolate
 Chocolat
 Schokolade
 Chocolate



m

Tabacco
 Tobacco
 Tabac
 Tabak
 Tabaco



R

Rovere sbiancato
 Bleached wood
 Chêne
 Holz eiche
 Blanqueado



V7

Viola
 Violet
 Violet
 Pflaume
 Violeta



B7

Ciclamino
 Light mauve
 Cyclamene
 Bordeaux
 Morado



H7

Lilla
 Lilac
 Lilas
 Lila
 Lila



P7

Rosa
 Pink
 Rose
 Pink
 Rosa



Z7

Rosa pallido
 Pale rose
 Rose pâle
 Zartrose
 Rosa Palido



C

Cobalto
 Cobalt
 Cobalt
 Kobalt
 Cobalto



B

Blu
 Blue
 Bleu
 Blau
 Azul



M7

Carta da zucchero
 Sugar paper
 Papier de Sucre
 Pastelblau
 Papel de Azucar



N7

Petrolio
 Petroleum
 Pétrole
 Petroleum
 Petróleo



K7

Blu elettrico
Electric blue
Bleu Electrique
Kornblume
Azul Electrico



D7

Lavanda
Lavendal
Lavande
Lavendal
Lavanda



A

Azzurro
Light blue
Bleu Ciel
Azurblau
Celeste



X

Bordeaux
Claret red
Bordeaux
Bordeaux
Burdeos



S7

Rosso
Red
Rouge
Rot
Rojo



K

Corallo
Coral
Corail
Koralle
Coral



C7

Nuovo Corallo
New Coral
Nouveau Corail
Koralle neu
Nuevo Coral



F7

Carota
Carrot
Carotte
Mohrrübe
Zanahoria



O

Arancio
Orange
Orange
Orange
Naranja



J

Girasole
Sunflower
Tournesol
Sonnengelb
Girasol



G

Giallo
Yellow
Jaune
Gelb
Amarillo



L7

Lime
Lime
Lime
Limone
Lima



L

Vaniglia
Vanilla
Vanille
Vanille
Vainilla



T

Tortora
Turtle-dove
Tourterelle
Turteltaube
Tortola



V

Verde
Green
Vert
Grün
Verde



A7

Mela verde
Apple green
Vert pomme
Apfelgrün
Verde Manzana



E

Verde acido
Acid green
Vert acide
Pistazie
Pistacho



G7

Verde Prato
Green Meadow
Vert Gazon
Wiesengrün
Verde Prado



Q7

Oliva
Olive-green
Olive
Olivegrün
Oliva



Q

Acquamarina
Aquamarine
Aigue-marine
Aquamarin
Agua marina



Trolleys



- Carrelli multifunzionali
Vasta gamma di accessori disponibili
- Molteplici finiture
- Ruote speciali a grandezza maggiorata, fascia in gomma antistatica e antitraccia
- Angolari rinforzati
- Logo a richiesta
- Multifunctional trolleys
- A complete range of optional accessories
- Numerous customization choices
- The oversized wheels are anti-static, won't leave marks.
- Reinforced legs
- Company logo on demand
- Chariots multifonctions
- Complète dotation d'accessoires disponibles
- Variété de finitions
- Roulettes surdimensionnées spéciales, avec bande en caoutchouc synthétique conducteur antitraçage
- Arêtes renforcées
- Logo à la demande
- Multifunktioneller Trolley
- Grosse Auswahl von optionalem Zubehör
- Grosse Auswahl von Oberflächen- Variationen und Lack-Farben
- Besonders grossdimensionierte Rollenmitantistatischen Gummireifen, die keinen Abrieb hinterlassen
- Spezialverstärkte Beine
- Ihr Firmen-Logo auf Wunsch als Option
- Carros multifunción
- Vasta gama de accesorios opcionales
- Múltiples acabados
- Ruedas especiales de mayor tamaño, con cinta de goma antistática y antihuellas
- Angulares reforzados
- Logo a solicitud

MEPRÁ
S.p.A.

TROLLEYS

BUENOS AIRES

Gueridon



H cm 80
cm 50 x 50

H 31 1/2"
19 3/4" x 19 3/4"

DELUXE

011



012



Massello con angolari in acciaio inossidabile 18/10
Solid wood with 18/10 Stainless Steel legs
Massif avec arêtes en inox 18/10
Massivholz, Beine mit Edelstahl Rostfrei 18/10
Profilen verblendet
Tablero con angulares en acero inox 18/10

CHIC

013



014



015



Pannello nobilitato laccato lucido
Glossy, lacquered, laminated panel
Panneaux noble laqués
Glänzend, lackierte, laminierte Paneele
Tablero chapado lacado brillo

VIP

016



017



Massello con angolari in massello
Trolley and solid wood legs
Panneaux massif avec hanches massif
Trolley und Beine komplett aus Massivholz
Tablero macizo con angulares macizos

COLORI

015	013	011 016	012 017	014
Bianco White Blanc Weiss Blanco	Oro Gold Or Gold Oro	Noce Walnut Noyer Walnuss Nuez	Wengè	Nero Black Noir Schwarz Negro

TROLLEYS

LONDON



Gueridon

H cm 80
cm 60 x 40

H 31 1/2"
23 5/8" x 15 3/4"

H cm 80
cm 80 x 40

H 31 1/2"
31 1/2" x 15 3/4"

DELUXE

031



032



Massello con angolari in acciaio inossidabile 18/10
Solid wood with 18/10 Stainless Steel legs
Massif avec arêtes en inox 18/10
Massivholz, Beine mit Edelstahl Rostfrei 18/10
Profilen verblendet
Tablero con angulares en acero inox 18/10

CHIC

033



034



035



Pannello nobilitato laccato lucido
Glossy, lacquered, laminated panel
Panneaux noble laqués
Glänzend, lackierte, laminierte Paneele
Tablero chapado lacado brillo

VIP

036



037



Massello con angolari in massello
Trolley and solid wood legs
Panneaux massif
Trolley und Beine komplett aus Massivholz
Tablero macizo con angulares macizos

COLORI

035	033	031 036	032 037	034
Bianco White Blanc Weiss Blanco	Oro Gold Or Gold Oro	Noce Walnut Noyer Walnuss Nuez	Wengè	Nero Black Noir Schwarz Negro

TROLLEYS

HAVANA



H cm 87
cm 50 x 50

H 34 1/4"
19 3/4" x 19 3/4"

DELUXE

121



122



Massello con angolari in acciaio inossidabile 18/10
Solid wood with 18/10 Stainless Steel legs
Massif avec angle en inox 18/10
Massivholz, Beine mit Edelstahl Rostfrei 18/10
Profilen verblendet
Tablero con angulares en acero inox 18/10

CHIC

123

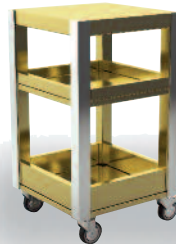

124



125



Pannello nobilitato laccato lucido
Glossy, lacquered, laminated panel with 18/10 Stainless Steel legs
Panneaux noble laqués
Glänzend, lackierte, laminierte Paneele mit Griffen in Edestahl
Rostfrei 18/10
Tablero chapado lacado brillo

VIP

126



127



Massello con angolari in massello
Trolley and solid wood legs
Panneaux massif avec angles et hanches massif
Trolley und Beine komplett aus Massivholz
Tablero macizo con angulares macizos

COLORI

125	123	121 126	122 127	124
Bianco White Blanc Weiss Blanco	Oro Gold Or Gold Oro	Noce Walnut Noyer Walnuss Nuez	Wengè	Nero Black Noir Schwarz Negro

TROLLEYS

NIZZA



H cm 87
cm 50 x 50

H 34 1/4"
19 3/4" x 19 3/4"

DELUXE

091



092

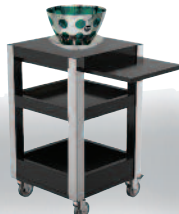

Massello con angolari e maniglioni in acciaio inossidabile 18/10
Solid wood with 18/10 Stainless Steel handles and legs
Massif avec arêtes et hanches en inox 18/10
Massivholz, Beine mit Edelstahl Rostfrei 18/10 Profilen
verblendet, Griffe 18/10
Tablero con angulares y asas en acero inox 18/10

CHIC

093



094

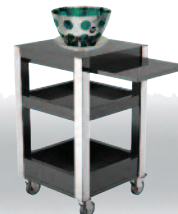

095



Pannello nobilitato laccato lucido
Glossy, lacquered, laminated panel 18/10 Stainless Steel handles and legs
Panneaux noble laqués
Glänzend, lackierte, laminierte Paneele mit Griffen und Beine in Edestahl
Rostfrei 18/10
Tablero chapado lacado brillo

Questo carrello comprende un inserto avvitato sul piano ed il relativo secchiello per champagne, art. 599 + art. 589 (colore a vostra scelta).

This trolley includes a screwed insert onto the top and the relative champagne cooler, art. 599 + art. 589 (color to your choice).

Ce chariot comprend un supplément vissé sur l'étage et le relatif seau à champagne, art. 599 + art. 589 (couleur à votre choix).

Dieser Trolley einschl. fixiertem Halter für Weinkühler, art. 599 einschl. Weinkühler mit Einsatz, art. 589 (Farben zu Ihrer Wahl).

Esto carro comprende un legajo atornillado sobre el plan y el relativo cubo por champán, art. 599 + art. 589 (color a vuestra elección).

COLORI

095	093	091	092	094
Bianco White Blanc Weiss Blanco	Oro Gold Or Gold Oro	Noce Walnut Noyer Walnuss Nuez	Wengè	Nero Black Noir Schwarz Negro

TROLLEYS

LAS VEGAS



H cm 83
cm 104 x 57

H 32 3/4"
41" x 22 1/2"

H cm 83
cm 124 x 57

H 32 3/4"
48 3/4" x 22 1/2"

DELUXE

051



052



Massello con angolari e maniglioni in acciaio inossidabile 18/10
Solid wood with 18/10 Stainless Steel handles and legs
Massif avec arêtes et hanches en inox 18/10
Massivholz, Beine mit Edelstahl Rostfrei 18/10 Profilen
verblendet, Griffe 18/10
Tablero con angulares y asas en acero inox 18/10

CHIC

053



054



055



Pannello nobilitato laccato lucido
Glossy, lacquered, laminated panel 18/10 Stainless Steel handles and legs
Panneaux noble laqués
Glänzend, lackierte, laminierte Paneele mit Griffen und Beine in Edestahl
Rostfrei 18/10
Tablero chapado lacado brillo

VIP

056



057



Massello con angolari e maniglioni in massello
Trolley and solid wood handles and legs
Panneaux massif avec angles et hanches massif
Trolley und Beine komplett aus Massivholz
Tablero macizo con angulares y asas macizas

COLORI

055	053	051 056	052 057	054
Bianco White Blanc Weiss Blanco	Oro Gold Or Gold Oro	Noce Walnut Noyer Walnuss Nuez	Wengè	Nero Black Noir Schwarz Negro

TROLLEYS

BARCELONA

Cabinet to accomodate serving pieces



H cm 83
cm 104 x 57

H 32 3/4"
41" x 22 1/2"

DELUXE

071

072



Massello con angolari e maniglioni in acciaio inossidabile 18/10
Solid wood with 18/10 Stainless Steel handles and legs
Massif avec angle et haneses en inox 18/10
Massivholz, Beine mit Edelstahl Rostfrei 18/10 Profilen verblendet, Griffe 18/10
Tablero con angulares y asas en acero inox 18/10

VIP

076

077



Massello con angolari e maniglioni in massello
Trolley and solid wood handles and legs
Panneaux massif avec angles et haneses massif
Trolley, Beine und Griffe komplett aus Massivholz
Tablero macizo con angulares y asas macizas

COLORI

		071 076	072 077	
Bianco White Blanc Weiss Blanco	Oro Gold Or Gold Oro	Noce Walnut Noyer Walnuss Nuez	Wengè	Nero Black Noir Schwarz Negro

TROLLEYS

DUBAI

Full-length cabinet for serving pieces



H cm 83
cm 124 x 57

H 32 3/4"
48 3/4" x 22 1/2"

DELUXE

081

082



Massello con angolari e maniglioni in acciaio inossidabile 18/10
Solid wood with 18/10 Stainless Steel handles and legs
Massif avec angle et hanches en inox 18/10
Massivholz, Beine mit Edelstahl Rostfrei 18/10 Profilen verblendet, Griffe 18/10
Tablero con angulares y asas en acero inox 18/10

VIP

086

087



Massello con angolari e maniglioni in massello
Trolley and solid wood handles and legs
Panneaux massif avec angles et hanches massif
Trolley, Beine und Griffe komplett aus Massivholz
Tablero macizo con angulares y asas macizas

COLORI

		081 086	082 087	
Bianco White Blanc Weiss Blanco	Oro Gold Or Gold Oro	Noce Walnut Noyer Walnuss Nuez	Wengè	Nero Black Noir Schwarz Negro

TROLLEYS

DALLAS



H cm 83
cm 104 x 57

H 32 3/4"
41" x 22 1/2"

DELUXE

041



042



Massello con angolari e maniglioni in acciaio inossidabile 18/10
Solid wood with 18/10 Stainless Steel handles and legs
Massif avec arêtes et hanches en inox 18/10
Massivholz, Beine mit Edelstahl Rostfrei 18/10 Profilen
verblendet, Griffe 18/10
Tablero con angulares y asas en acero inox 18/10

CHIC

043



044



045



Pannello nobilitato laccato lucido
Glossy, lacquered, laminated panel 18/10 Stainless Steel handles and legs
Panneaux noble laqués
Glänzend, lackierte, laminierte Paneele mit Griffen und Beine in Edestahl
Rostfrei 18/10
Tablero chapado lacado brillo

VIP

046



047



Massello con angolari e maniglioni in massello
Trolley and solid wood handles and legs
Panneaux massif avec angles et hanches massif
Trolley und Beine komplett aus Massivholz
Tablero macizo con angulares y asas macizas

COLORI

045	043	041 046	042 047	044
Bianco White Blanc Weiss Blanco	Oro Gold Or Gold Oro	Noce Walnut Noyer Walnuss Nuez	Wengè	Nero Black Noir Schwarz Negro

SOLFERINO



H cm 83
cm 104 x 57

H 32 3/4"
41" x 22 1/2"

DELUXE

221

222



Massello con maniglioni in acciaio inossidabile 18/10
Solid wood with 18/10 Stainless Steel legs
Massif avec haneses en inox 18/10
Massivholz mit Griffen in Edelstahl Rostfrei 18/10
Tablero macizo con asa en acero inox 18/10

CHIC

223

224

225



Pannello nobilitato laccato lucido con maniglioni in acciaio inossidabile 18/10
Glossy, lacquered, laminated panel with handles in 18/10 Stainless Steel
Panneaux noble laqués et haneses en inox 18/10
Glänzend, lackierte, laminierte Paneele mit Griffen in Edelstahl Rostfrei 18/10
Tablero chapado lacado brillo con asa en acero inox 18/10

COLORI

225	223	221	222	224
Bianco White Blanc Weiss Blanco	Oro Gold Or Gold Oro	Noce Walnut Noyer Walnuss Nuez	Wengè	Nero Black Noir Schwarz Negro

TROLLEYS

MIAMI



H cm 82
cm 80 x 91

H 32 1/4"
31 1/2" x 35 7/8"

DELUXE

106



107



Massello con angolari in acciaio inossidabile 18/10
Solid wood with 18/10 Stainless Steel legs
Massif avec angle en inox 18/10
Massivholz, Beine mit Edelstahl Rostfrei 18/10
Profilen verblendet
Tablero con angulares en acero inox 18/10

CHIC

103



104



105



Pannello nobilitato laccato lucido
Glossy, lacquered, laminated panel with 18/10 Stainless Steel legs
Panneaux noble laqués
Glänzend, lackierte, laminierte Paneele mit Griffen in Edestahl
Rostfrei 18/10
Tablero chapado lacado brillo

VIP

101



102



Massello con angolari in massello
Trolley and solid wood legs
Panneaux massif avec angles et hanches massif
Trolley und Beine komplett aus Massivholz
Tablero macizo con angulares macizos

COLORI

105	103	101 106	102 107	104
Bianco White Blanc Weiss Blanco	Oro Gold Or Gold Oro	Noce Walnut Noyer Walnuss Nuez	Wengè	Nero Black Noir Schwarz Negro



MANIGLIA

Maniglione a scomparsa, regolabile in altezza, per la corretta postura della schiena durante la movimentazione.

HANDLE

The foldaway handle can be ergonomically adjusted to the height of the user during transport.

POIGNÉE

Poignée disparible, réglable en hauteur, pour la posture correcte du dos pendant le mouvements.

SCHIEBEGRIFF

Der einklappbare Schiebegriff kann ergonomisch exakt auf die passende Höhe des Fahrers eingestellt werden, die er zum jeweiligen Transport benötigt.

AGARRADOR

Agarrador abatible, ajustable en altura, para una correcta postura de la espalda durante el uso.



HOT BOX

Contenitore Hot Box elettrico a 4 scomparti, con termostato regolabile fino a 90° C. Diametro massimo dei piatti inseribili: 31 cm.

HOT BOX

Electric Hot Box compartment, 4 compartments with adjustable thermostat up to 194° F. Maximum inner dimension:: 12 1/2".

HOT BOX

Récipient Hot Box électrique aux 4 compartiments, avec thermostat réglable jusqu'à 90° C. Maximum diamètre des plats insertables: 31 cms.

HOT BOX

Elektrisch betriebene HOT BOX mit 4 Abteilungen, mit jeweils Nutzfläche bis zu 31 cm Durchmesser. Die HOT BOX ist ausgestattet mit einem regelbaren Thermostat bis zu 90° C.

HOT BOX

Contenedor eléctrico de 4 compartimentos, con termostato ajustable a 90° C. Diámetro máximo de los platos insertables: 31 cm.



PIANO SUPERIORE ESTENSIBILE

Piano superiore estensibile "a tavolino", massima estensione cm. 92 x 80

EXTENDABLE UPPER SURFACE

Upper surface can be extended up to 36 1/2" x 31 1/2"

PLAT SUPÉRIEUR EXTENSIBLE

Plat supérieur extensible, meilleure étendue cm. 92 x 80.

AUSKLAPPBARE TISCHFLÄCHE

Die Tischfläche kann durch Ausklappen vergrößert werden auf das Mass von 92 x 80 cm.

PLANO SUPERIOR EXTENSIBLE

Plano superior extensible, medida total extendida 92 x 80 cm.



CASSETTI

Cassetti portaposate, portatovaglie, scomparti portabottiglie e bicchieri.

DRAWERS

Drawers available for cutlery, table cloths and napkins. Compartments for wine bottles, glasses and stemware are also available.

TIROIRS

Tiroirs portecouverts, portenappes, compartiments portebouteilles et verres.

SCHUBLADEN

Es sind Schubladen erhältlich für Besteck, Tischwäsche und Servietten. Fächer für Weinflaschen, Becher und Stielgläser sind ebenfalls erhältlich.

CAJONES

Cajones para cubiertos, servilletas, manteles, y compartimentos para botellas y vasos.



CARATTERISTICHE

Alta resistenza, massima maneggevolezza, ruote maggiorate ed anti-statiche.

FEATURES

Durable oversized casters feature maximum maneuverability with non-tracking and non-conductive rubber wheels.

CARACTÉRISTIQUES

Haute résistance, meilleure maniabilité, roues augmentées et antistatiques.

BESONDERHEITEN

Die groß-dimensionierten, robusten Rollen aus antistatischem Gummi-Material erlauben eine hochgrade Beweglichkeit, selbst bei der Überwindung schwierigster Hindernisse und unterschiedlichsten Bödenbelägen.

CARACTERÍSTICAS

Alta resistencia, máxima manejabilidad, ruedas grandes y antiestáticas.

HOT BOX

Contenitore Hot Box elettrico a 4 scomparti, con termostato regolabile fino a 90° C. Diametro massimo dei piatti inseribili: 31 cm.

HOT BOX

Electric Hot Box compartment, 4 compartments with adjustable thermostat up to 194° F. Maximum inner dimension:: 12 1/2".

HOT BOX

Réipient Hot Box électrique aux 4 compartiments, avec thermostat réglable jusqu'à 90° C. Maximum diamètre des plats insertables: 31 cms.

HOT BOX

Elektrisch betriebene HOT BOX mit 4 Abteilungen, mit jeweils Nutzfläche bis zu 31 cm Durchmesser. Die HOT BOX ist ausgestattet mit einem regelbaren Thermostat bis zu 90° C.

HOT BOX

Contenedor eléctrico de 4 compartimentos, con termostato ajustable a 90° C. Diámetro máximo de los platos insertables: 31 cm.



DELUXE - VIP



H cm 5,5

H 21/4"

Tutte le versioni Deluxe e Vip hanno la struttura in massello e il piano superiore in massello listellare. Colori optional: faggio, ciliegio, rovere e mogano.

All the wood components for the Deluxe and VIP versions are made from solid wood and the workspace top is made from heavy duty solid Block Wood Available colors: Beachwood, Cherry, Oak and Mahogany

Toutes les versions Deluxe et Vip ont la structure en massif et le plan supérieur en massif. Couleurs facultatif: Hêtre, Cerise, Chêne et Acajou.

Alle Ausführungen für die Deluxe- und VIP-Versionen sind hergestellt aus massivem Holz und die oberen Arbeitsbereiche aus strapazierfähigem, solidem Blockholz
Verfügbare Farben: Buche, Kirsche, Eiche und Mahagoni

Todas las versiones "Deluxe" y "Vip" tienen la estructura en tablero macizo y el plano superior en tablero macizo listelar
Colores disponibles: Haya, Cerezo, Roble y Caoba

CHIC



H cm 4

H 15/8"

La versione Chic è interamente in nobilitato laccato lucido, con il piano superiore di alto spessore. The Chic version has an entirely glossy, lacquered, laminate faced finish with a heavy duty workspace top. La version Chic est tout à fait de panneaux noble laqués, avec le plan supérieur de grande épaisseur. Die Chic-Versionen haben ein gänzlich glänzendes, lackiertes, laminiertes Finish mit einem strapazierfähigen oberen Arbeits-Top. La versión "Chic" es enteramente chapado lacado brillo, y con el plano superior de alto espesor.

RICAMBI

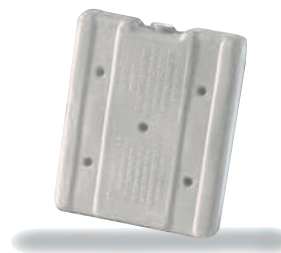

cm 15,5 x 7,5
H cm 2

6" x 27/8"
H 1"

Piastre eutettiche senza evaporatore, disponibili per tutte le cupole: congelate a -21°C, durano fino a tre ore. Eutectic cooling plates without evaporator are available for all of the roll-top covers. Refrigerated to -5,8°F, they will keep cool for approximately 3 hours. Bacs eutectiques sans evaporateur, sont disponibles pour toutes les lavallières: réfrigérée à -21° C, ils durent jusqu'à trois heures. Eutektische Kühlplatten ohne Verdampfer, für alle Roll-top Aufsatz erhältlich: vor dem Gebrauch, im Gefrierschrank mit -21°C abkühlen; damit verfügen Sie über 3 Stunden Kühlleistung. Planchas eutecticas sin vaporizador, disponibles para todas las cúpulas: congeláis a -21°C, duran hasta tres horas.

800



H cm 29
cm 11 x 11

H 11 3/4"
4 1/2" x 4 1/2"

Campionario colore per sala esposizione
Colori disponibili: noce, wengè, bianco, nero e oro.

Color Displayer for show room
Available colors: walnut, wenge, gold, black and white.

Couleur Displayer pour show room
Couleurs disponibles: Noyer, Wenge, Blanc, Noir et Or.

Farben Displayer für Show-Room
Erhältliche Farben: Walnuss, Wenge, Weiss, Schwarz und Gold.

Color Displayer para sala de exposiciones
Colores disponibles: Nogal, Wenge, Blanco, Negro y Oro.

ACCESSORI

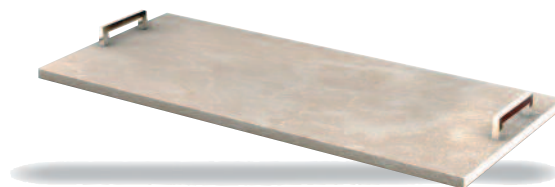

cm 83 x 36
H cm 2

32 3/4" x 14 1/4"
H 1"

Piano in marmo granito, perfettamente levigato e lucidato. Perfectly ground and polished granite marble top surface. Plan en marbre granulé, parfaitement lissé et poli. Polierte Granit-Marmor-Platte mit perfekt glatt geschliffener Oberfläche
Plano en mármol granito, perfectamente pulido.

PARIS

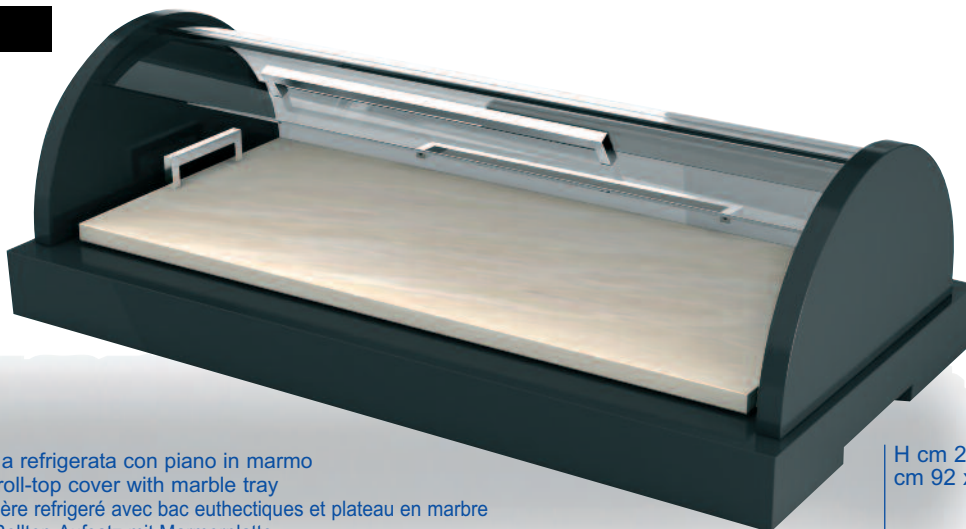

Cupola refrigerata con piano in marmo
Cool roll-top cover with marble tray
Lavallière réfrigéré avec bac eutectiques et plateau en marbre
Kühl-Rolltop-Aufsatz mit Marmorplatte
Cúpula refrigerada con plano en mármol

H cm 28,5
cm 92 x 47

H 11 $\frac{1}{2}$ "
36 $\frac{1}{2}$ " x 18 $\frac{1}{2}$ "

DELUXE

161

162



Massello
Solid wood
Massif
Massivholz
Tablero macizo

CHIC

163

164

165



Pannello nobilitato laccato lucido
Glossy, lacquered, laminated panel
Panneaux noble laqués
Glänzend, lackierte, laminierte Paneele
Tablero chapado lacado brillo

COLORI



- 3 Piastre eutettiche senza evaporatore sono già inserite nella cupola refrigerata
- 3 Eutectic cooling plates without evaporator are already inserted into the roll-top cover
- 3 Bacs eutectiques sans évaporateur sont déjà insérés dans la lavallière
- 3 Bereits eingelegte Kühlaccus gehören mit zum Lieferumfang
- 3 Planchas eutecticas sin vaporizador son ya insertadas en la cúpula refrigerada

165	163	161	162	164
Bianco White Blanc Weiss Blanco	Oro Gold Or Gold Oro	Noce Walnut Noyer Walnuss Nuez	Wengè	Nero Black Noir Schwarz Negro

WIEN

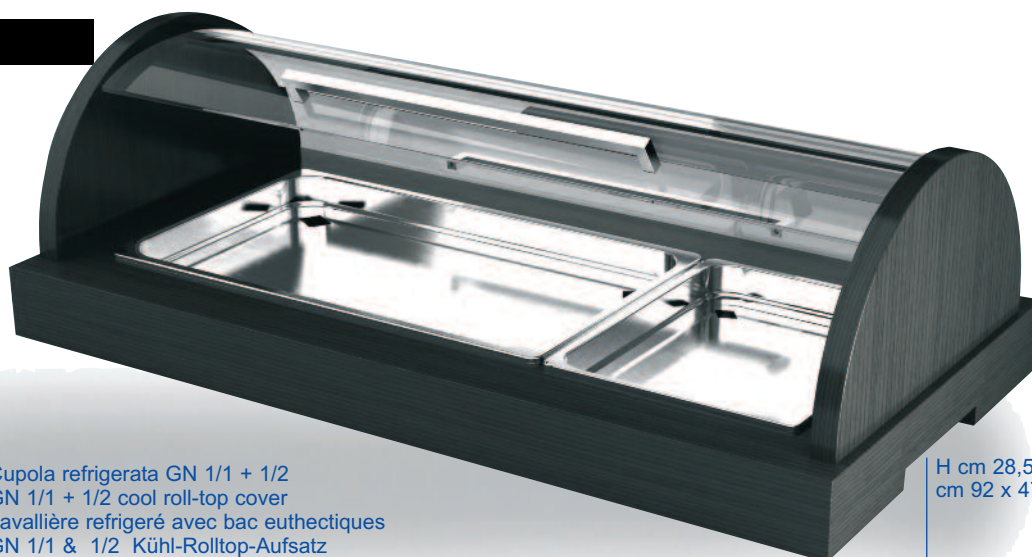

Cupola refrigerata GN 1/1 + 1/2
GN 1/1 + 1/2 cool roll-top cover
Lavallière réfrigéré avec bac eutectiques
GN 1/1 & 1/2 Kühl-Rolltop-Aufsatz
Cúpula refrigerada GN 1/1 -1/2

H cm 28,5
cm 92 x 47

H 11 1/4"
36 1/4" x 18 1/2"

DELUXE

141

142



Massello
Solid wood
Massif
Massivholz
Tablero macizo

CHIC

143

144

145



Pannello nobilitato laccato lucido
Glossy, lacquered, laminated panel
Panneaux noble laqués
Glänzend, lackierte, laminierte Paneele
Tablero chapado lacado brillo

COLORI



- 3 Piastre eutettiche senza evaporatore sono già inserite nella cupola refrigerata
- 3 Eutectic cooling plates without evaporator are already inserted into the roll-top cover
- 3 Bacs eutectiques sans évaporateur sont déjà insérés dans la lavallière
- 3 Bereits eingelegte Kühlaccus gehören mit zum Lieferumfang
- 3 Planchas eutecticas sin vaporizador son ya insertadas en la cúpula refrigerada

145	143	141	142	144
Bianco White Blanc Weiss Blanco	Oro Gold Or Gold Oro	Noce Walnut Noyer Walnuss Nuez	Wengè	Nero Black Noir Schwarz Negro

GRUYERE



Cupola refrigerata GN 1/1
GN 1/1 cool roll-top cover
Lavallière réfrigéré avec bac eutectiques
GN 1/1 Kühl-Rolltop-Aufsatz
Cúpula refrigerada GN 1/1

H cm 29
cm 63 x 47

H 11 7/8"
24 7/8" x 18 1/2"

DELUXE

261



262



Massello
Solid wood
Massif
Massivholz
Tablero macizo

CHIC

263



264



265



Pannello nobilitato laccato lucido
Glossy, lacquered, laminated panel
Panneaux noble laqués
Glänzend, lackierte, laminierte Paneele
Tablero chapado lacado brillo

COLORI



- 2 Piastre eutettiche senza evaporatore sono già inserite nella cupola refrigerata
- 2 Eutectic cooling plates without evaporator are already inserted into the roll-top cover
- 2 Bacs eutectiques sans évaporateur sont déjà insérés dans la lavallière
- 2 Bereits eingelegte Kühlaccus gehören mit zum Lieferumfang
- 2 Planchas eutecticas sin vaporizador son ya insertadas en la cúpula refrigerada

265	263	261	262	264
Bianco White Blanc Weiss Blanco	Oro Gold Or Gold Oro	Noce Walnut Noyer Walnuss Nuez	Wengè	Nero Black Noir Schwarz Negro

PRAGA



Cupola refrigerata GN 1/1
GN 1/1 cool roll-top cover
Lavallière réfrigéré avec bac eutectiques
GN 1/1 Kühl-Rolltop-Aufsatz
Cúpula refrigerada GN 1/1

H cm 29
cm 63 x 47

H 11 7/8"
24 7/8" x 18 1/2"

DELUXE

281

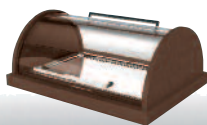

282

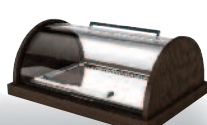

Massello
Solid wood
Massif
Massivholz
Tablero macizo

CHIC

283

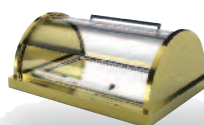

284



285

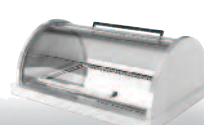

Pannello nobilitato laccato lucido
Glossy, lacquered, laminated panel
Panneaux noble laqués
Glänzend, lackierte, laminierte Paneele
Tablero chapado lacado brillo

COLORI



- 2 Piastre eutettiche senza evaporatore sono già inserite nella cupola refrigerata
- 2 Eutectic cooling plates without evaporator are already inserted into the roll-top cover
- 2 Bacs eutectiques sans évaporateur sont déjà insérés dans la lavallière
- 2 Bereits eingelegte Kühlelaccus gehören mit zum Lieferumfang
- 2 Planchas eutecticas sin vaporizador son ya insertadas en la cúpula refrigerada

285	283	281	282	284
Bianco White Blanc Weiss Blanco	Oro Gold Or Gold Oro	Noce Walnut Noyer Walnuss Nuez	Wengè	Nero Black Noir Schwarz Negro

SPARTA



Cúpola refrigerata a 2 piani GN 1/1
 GN 1/1 cool roll-top cover 2 layers
 Lavallière réfrigéré 2 étages avec bac eutectiques
 GN 1/1 Kühl-Rolltop-Aufsatz 2-stufig
 Cúpula refrigerada 2 pisos GN 1/1

H cm 58
 cm 63 x 47

H 22 7/8"
 24 7/8" x 18 1/2"

DELUXE

271



272



Massello
 Solid wood
 Massif
 Massivholz
 Tablero macizo

CHIC

273



274



275



Pannello nobilitato laccato lucido
 Glossy, lacquered, laminated panel
 Panneaux noble laqués
 Glänzend, lackierte, laminierte Paneele
 Tablero chapado lacado brillo

COLORI



- 4 Piastre eutettiche senza evaporatore sono già inserite nella cúpola refrigerata
- 4 Eutectic cooling plates without evaporator are already inserted into the roll-top cover
- 4 Bacs eutectiques sans évaporateur sont déjà insérés dans la lavallière
- 4 Bereits eingelegte Kühlaccus gehören mit zum Lieferumfang
- 4 Planchas eutecticas sin vaporizador son ya insertadas en la cúpula refrigerada

275	273	271	272	274
Bianco White Blanc Weiss Blanco	Oro Gold Or Gold Oro	Noce Walnut Noyer Walnuss Nuez	Wengè	Nero Black Noir Schwarz Negro

TROLLEYS

ATENE



Cupola refrigerata a 2 piani GN 1/1
 GN 1/1 cool roll-top cover 2 layers
 Lavallière réfrigéré 2 étages avec bac eutectiques
 GN 1/1 Kühl-Rolltop-Aufsatz 2-stufig
 Cúpula refrigerada 2 pisos GN 1/1

H cm 58
 cm 63 x 47

H 22 7/8"
 24 7/8" x 18 1/2"

DELUXE

151



152



Massello
 Solid wood
 Massif
 Massivholz
 Tablero macizo

CHIC

153

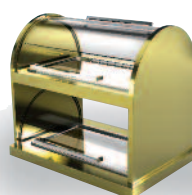

154



155



Pannello nobilitato laccato lucido
 Glossy, lacquered, laminated panel
 Panneaux noble laqués
 Glänzend, lackierte, laminierte Paneele
 Tablero chapado lacado brillo

COLORI



- 4 Piastre eutettiche senza evaporatore sono già inserite nella cupola refrigerata
- 4 Eutectic cooling plates without evaporator are already inserted into the roll-top cover
- 4 Bacs eutectiques sans évaporateur sont déjà insérés dans la lavallière
- 4 Bereits eingelegte Kühlaccus gehören mit zum Lieferumfang
- 4 Planchas eutecticas sin vaporizador son ya insertadas en la cúpula refrigerada

155	153	151	152	154
Bianco White Blanc Weiss Blanco	Oro Gold Or Gold Oro	Noce Walnut Noyer Walnuss Nuez	Wengè	Nero Black Noir Schwarz Negro

RADICE OVALE



NATURAL

WHITE

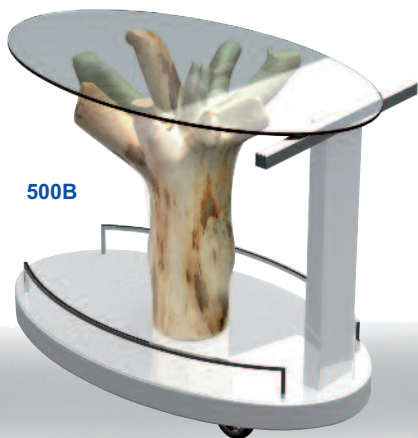

500B

NATURAL

BLACK

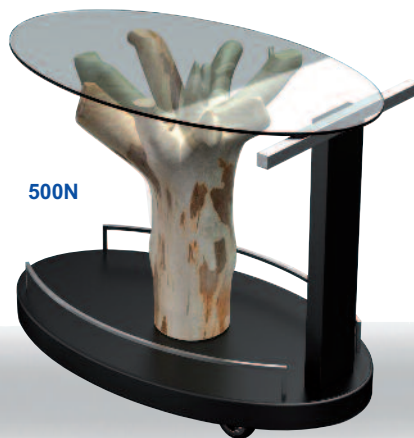

500N

Ogni carrello è un pezzo unico: la radice proviene dai rigogliosi boschi del Nord Italia, raccolta e lavorata dai nostri artigiani dopo la caduta spontanea dell'albero a terra. I cristalli sono temperati, spessore 10 mm.

Each trolley is unique: the root comes from the lush forests of Northern Italy, and is collected and processed by our craftsmen after the tree's natural fall. The crystals are 10mm thick and tempered.

Chaque table est unique: la racine provient des forêts luxuriantes du nord de l'Italie, récoltées et traitées par nos artisans après la chute spontanée de l'arbre sur le sol. Les cristaux sont tempérés, épaisseur 10 mm.



BLACK



504

Jeder Trolley ist einzigartig: die Wurzel stammt aus den dichten Wäldern von Nord-Italien. Nachdem der Baum auf natürliche Weise zu Fall kam, werden die einzelnen Wurzelstücke von unseren Handwerkern eingesammelt und verarbeitet. Die Glasplatte ist aus Spezialglas mit 10mm Dicke.

WHITE

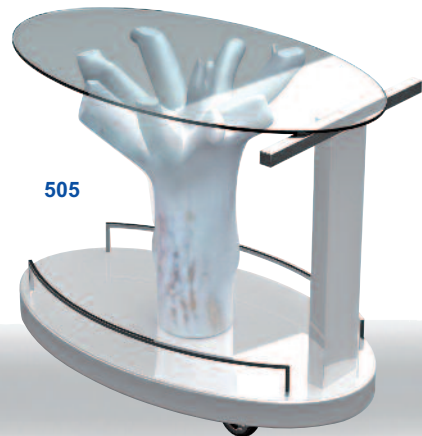

505

Cada carro es único: la raíz viene de los exuberantes bosques del norte de Italia, producidas y elaboradas por nuestros artesanos después de la caída espontánea del árbol al suelo. Los cristales son templados, espesor 10 mm.

H cm 83
cm 100 x 57

H 32 3/4"
39 1/2" x 22 1/2"

RADICE RETTANGOLARE



NATURAL

WHITE



510B

NATURAL

BLACK

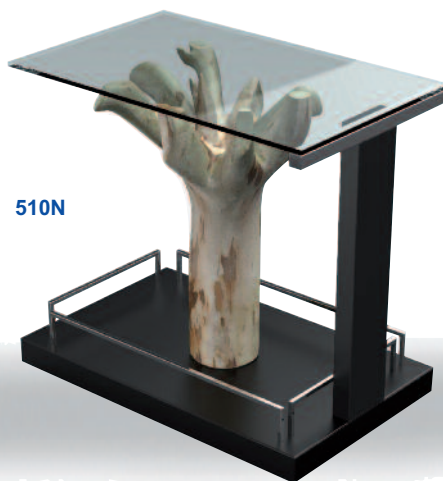

510N

Ogni carrello è un pezzo unico: la radice proviene dai rigogliosi boschi del Nord Italia, raccolta e lavorata dai nostri artigiani dopo la caduta spontanea dell'albero a terra. I cristalli sono temperati, spessore 10 mm.

Each trolley is unique: the root comes from the lush forests of Northern Italy, and is collected and processed by our craftsmen after the tree's natural fall. The crystals are 10mm thick and tempered.

Chaque table est unique: la racine provient des forêts luxuriantes du nord de l'Italie, récoltées et traitées par nos artisans après la chute spontanée de l'arbre sur le sol. Les cristaux sont tempérés, épaisseur 10 mm.



BLACK



514

WHITE

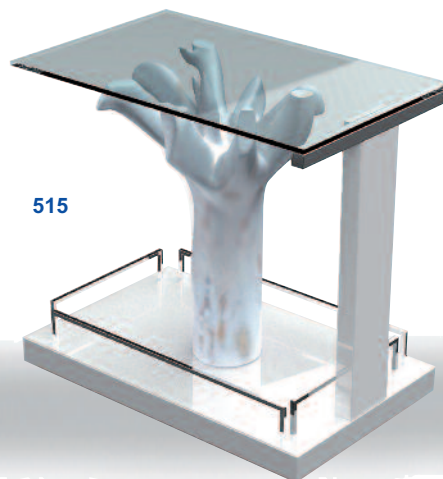

515

Jeder Trolley ist einzigartig: die Wurzel stammt aus den dichten Wäldern von Nord-Italien. Nachdem der Baum auf natürliche Weise zu Fall kam, werden die einzelnen Wurzelstücke von unseren Handwerkern eingesammelt und verarbeitet. Die Glasplatte ist aus Spezialglas mit 10mm Dicke.

Cada carro es único: la raíz viene de los exuberantes bosques del norte de Italia, producidas y elaboradas por nuestros artesanos después de la caída espontánea del árbol al suelo. Los cristales son templados, espesor 10 mm.

H cm 80
cm 80 x 50

H 31 1/2"
31 1/2" x 19 3/4"

RADICE QUADRA



NATURAL

WHITE

520B

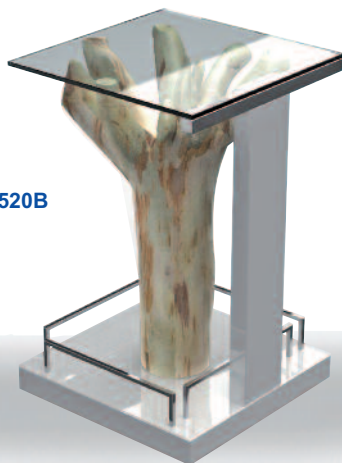

NATURAL

BLACK

520N

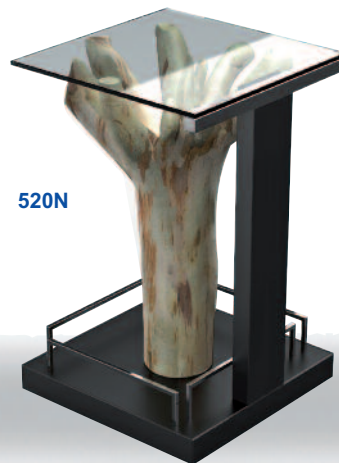

Ogni carrello è un pezzo unico: la radice proviene dai rigogliosi boschi del Nord Italia, raccolta e lavorata dai nostri artigiani dopo la caduta spontanea dell'albero a terra. I cristalli sono temperati, spessore 10 mm.

Each trolley is unique: the root comes from the lush forests of Northern Italy, and is collected and processed by our craftsmen after the tree's natural fall. The crystals are 10mm thick and tempered.

Chaque table est unique: la racine provient des forêts luxuriantes du nord de l'Italie, récoltées et traitées par nos artisans après la chute spontanée de l'arbre sur le sol. Les cristaux sont tempérés, épaisseur 10 mm.

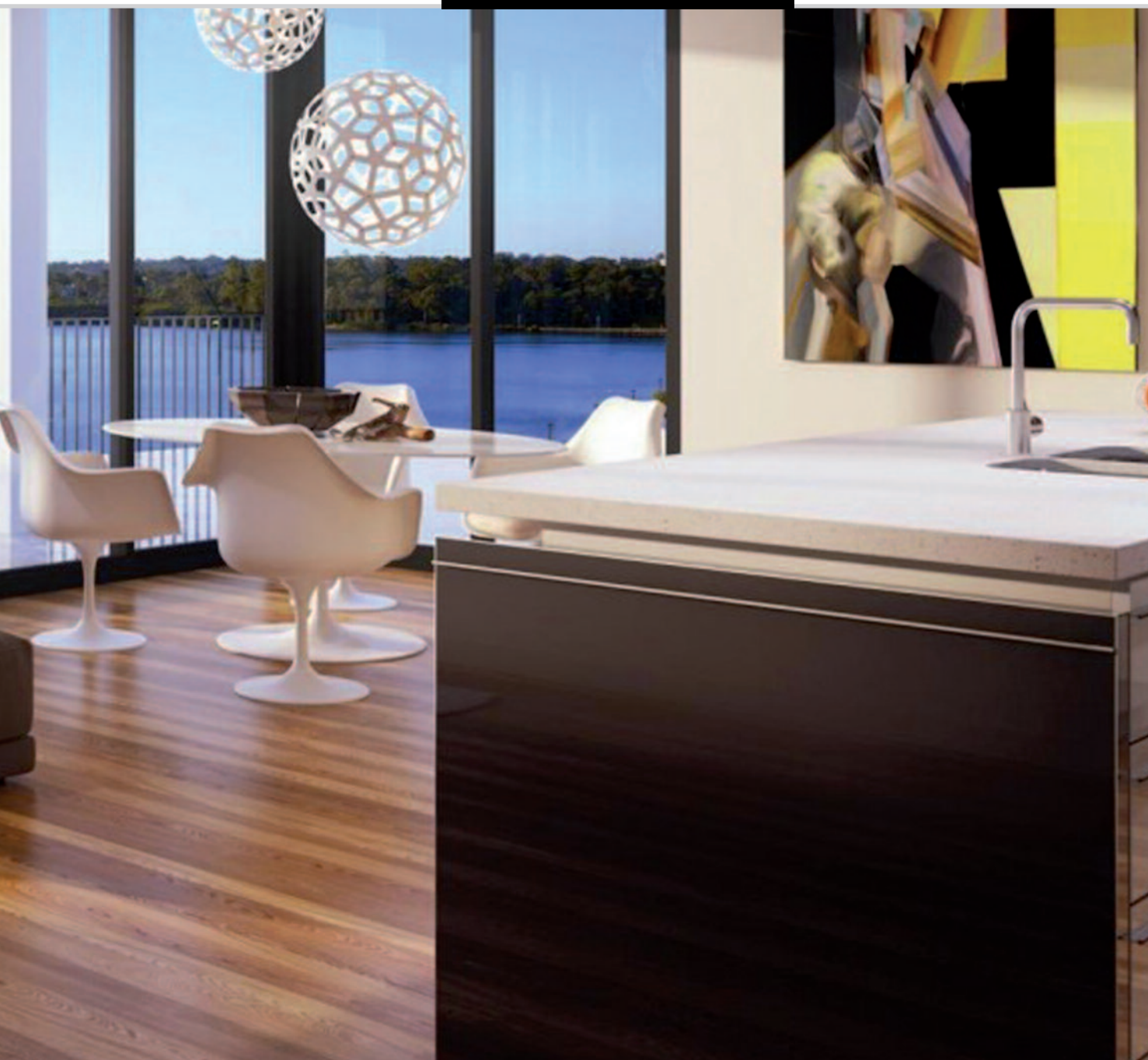

BLACK

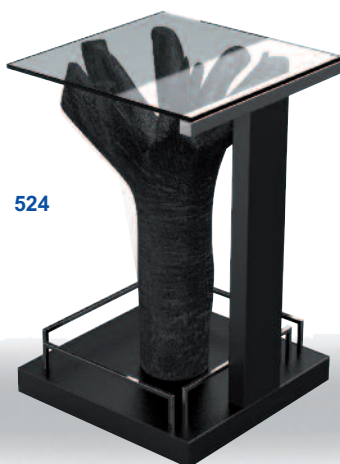

524

WHITE

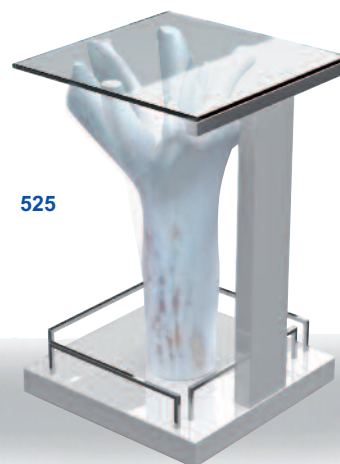

525

Jeder Trolley ist einzigartig: die Wurzel stammt aus den dichten Wäldern von Nord-Italien. Nachdem der Baum auf natürliche Weise zu Fall kam, werden die einzelnen Wurzelstücke von unseren Handwerkern eingesammelt und verarbeitet. Die Glasplatte ist aus Spezialglas mit 10mm Dicke.

Cada carro es único: la raíz viene de los exuberantes bosques del norte de Italia, producidas y elaboradas por nuestros artesanos después de la caída espontánea del árbol al suelo. Los cristales son templados, espesor 10 mm.

H cm 85
cm 50 x 50

H 33 3/8"
19 3/4" x 19 3/4"

TROLLEYS

TEVERE



H cm 80
cm 80 x 40

H 31 1/2"
31 1/2" x 15 3/4"

302



Pannello nobilitato in essenza
Laminated panel
Panneaux noble
Lackierte Paneele
Tablero lacado

308



Pannello nobilitato in essenza
Laminated panel
Panneaux noble
Lackierte Paneele
Tablero lacado

309



Pannello nobilitato in essenza
Laminated panel
Panneaux noble
Lackierte Paneele
Tablero lacado

COLORI

302	308	309
Wengè	Bronzo Copper Cuivre Kupfer Cobre	Castagno chiaro Light chestnut Châtain clair Heile Kastanie Castaño claro

TROLLEYS

MISSISSIPPI



H cm 85
cm 98 x 57

H 33 1/2"
38 5/8" x 22 3/8"

332



Pannello nobilitato in essenza
Laminated panel
Panneaux noble
Lackierte Paneele
Tablero lacado

338



Pannello nobilitato in essenza
Laminated panel
Panneaux noble
Lackierte Paneele
Tablero lacado

339



Pannello nobilitato in essenza
Laminated panel
Panneaux noble
Lackierte Paneele
Tablero lacado

COLORI

332	338	339
Wengè	Bronzo Copper Cuivre Kupfer Cobre	Castagno chiaro Light chestnut Châtain clair Heile Kastanie Castaño claro

TROLLEYS

RENO



H cm 85
cm 50 x 50

H 33 1/2"
19 3/4" x 19 3/4"

322



Pannello nobilitato in essenza
Laminated panel
Panneaux noble
Lackierte Paneele
Tablero lacado

328



Pannello nobilitato in essenza
Laminated panel
Panneaux noble
Lackierte Paneele
Tablero lacado

329



Pannello nobilitato in essenza
Laminated panel
Panneaux noble
Lackierte Paneele
Tablero lacado

COLORI

322	328	329
Wengè	Bronzo Copper Cuivre Kupfer Cobre	Castagno chiaro Light chestnut Châtain clair Heile Kastanie Castaño claro

Alta resistenza al graffio per il normale utilizzo

High resistance to scratch for normal use
 Hautes résistance aux griffures
 Kratzfest bei normalem Gebrauch.
 Alta resistencia a las rayas resultantes del uso normal

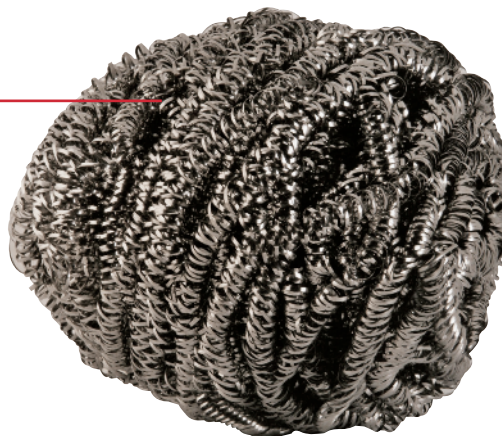

Idrorepellente non cambia colore a contatto con liquidi e cibi

Hydro repellant, it doesn't change colour when in contact with liquids or foods.
 Matière ne subissant aucunes agressions exterieurs, liquide et autres.....
 Wasserfest, keine Farbveränderung bei Kontakt mit Flüssigkeiten oder Esswaren.
 Repelente al agua, no cambia de color al entrar en contacto con líquidos y alimentos.

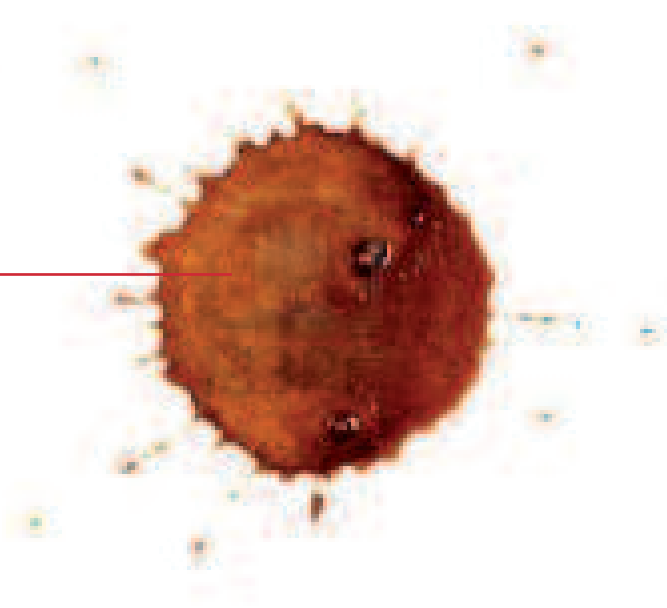

**Ruote speciali a grandezza maggiorata, fascia in gomma antistatica e antitraccia.
 Ruote e struttura potenziate ad alta portata**

The oversized wheels are antistatic, won't leave marks.
 Wheels and enhanced high-range structure.
 Roulettes surdimensionnées spéciales, avec bande en caoutchouc synthétique conducteur antitrace.
 Roues et roulements adaptées en fonction du poids de la table roulante.
 Besonders grossdimensionierte Rollen mit antistatischen Gummireifen, die keinen Abrieb hinterlassen.
 Die Rollen und das Gefüge verstärkte sind, um grössere Fähigkeit zu tragen.
 Ruedas especiales de mayor tamaño, con cinta de goma antistatica y antihuellas.
 Ruedas y estructura mejoradas de alta capacidad.

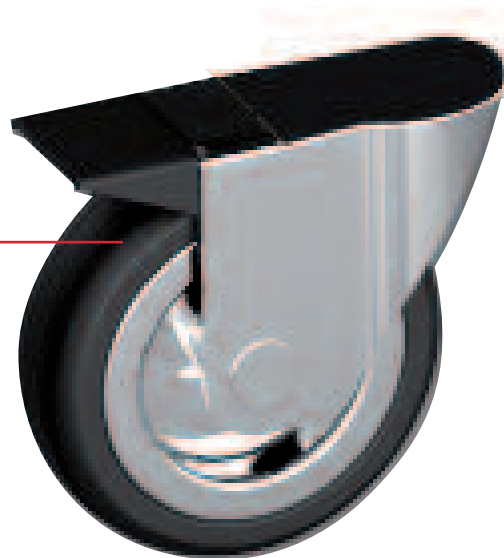



INDICE

INDEX

INDEX

ALPHABETISCHES REGISTER

INDICE

NUMERI

RESTAURANT

HOTEL

Indice

A B

	Pag
Agitatore	213
Agitatore Boston	213
Allacciatoavaglioli	141,149,235
Alzata dolci	79,82,139,156
Alzata pane	96
Alzata pesce crudo	85,93,118,119,120,143
Alzata portafrutta	78,79,82,93,139,156
Alzata portapiatti	83
Alzata torta	80,92,138
Ampolla	81,108,158,159,178,232
Antipastiera	142,143,148,151,153,155 180,231,236
Appoggia chop sticks	67
Appoggia posate	73,197
Apriostriche	120
Bicchiere	106,192,247,251,254
Bistecchiera	243
Bottiglia	108
Braciere con griglia	115,178
Bricco	203
Brocca per acqua	206
Bugia	89,144

C

Caffettiera	82,145,201,202,205,206 207
Caffettiera termica	201,202,205
Candelabro	83,89,144,199
Caraffa per bibite	195,250
Caraffa termica	201,202
Carrello portavivande	261 <> 272,280 <> 288
Casseruola	241,243
Cavatappi	174
Centrotavola	107,118,119,121,138,188 236
Cestino	96,97,101,102,103,104 105,107,118,119,123,138 152,153,155,157,172,188 231,235,247
Cestino portabonbon	155
Cestino portacondimenti	129,143,152,169,172
Cestino portafrutta	107,139,152,153,155,157
Cestino portapanne	80,96,138,149,151,152 155,235
Cestino portatovaglioli	96,208
Cesto porta agrumi	96,97,104,155,188,223 231,235
Chafing dish	196,198
Champagnera	215,225,228
Chillcup	81,98
Chop sticks	67
Ciambella termica	181
Ciotola in acciaio	78,97,138,169
Ciotola in legno	123
Ciotola in policarbonato	123,223,248,249
Ciotola in polipropilene	254
Cloche	83,86,163,168,173
Coffee Design Kit	211
Coffee Urn	197
Colino da cocktail	174
Colonna portasecchiello	84,94,95,105,123,135,216 217,218,219,220,221,223
Colonna portasigari	106
Coltelli	7 <> 43,71,72,73,120,179
Contenitore per bibite	195
Coperchio	86,108,161,162,166
Coperchio per legumiera e zuppiera	86,166
Coperchio per piatto ovale	162
Coppa burro	81,98
Coppa caviale	81,98
Coppa cocktail e scampi	81,98
Coppa con piede	80,85,89,213
Coppa crema/potage	166
Coppa intermezzo	170
Coppa in vetro	80,108
Coppa lavadita	168
Coppa Martini	170,251
Coppa multiservizio	80,138
Coppa per champagne	85,95,104
Coppa per gelato e/o macedonia	98,172,251
Coppa per pinzimonio	181

Pag

Coppa per punch	89,213
Coppa vichyssoise	98,166
Copripiatto	161,162,163
Cremiera	106,180,209
Cubetto luminoso LED	229
Cucchiaino da cocktail	7 <> 43
Cucchiaino per cappuccino	209
Cucchiaino per caviale	174
Cucchiaino sale	73,192
Cucchiaino agitatore	73,214
Cucchiaino monoporzione	69
Cucchiaino per bibita	7 <> 43
Cucchiaino per insalata	7 <> 43,197
Cucchiaino per parmigiano	7 <> 43
Cucchiaino per risotto	69,73,197,257
Cucchiaino per salsa	7 <> 43,257
Cucchiaino servire	7 <> 43,69,73,197
Culla porta champagne	199
Cupola refrigerata	274 <> 279

D E F

Distributore di latte	197
Distributore di succo di frutta	197
Dosatore sale e pepe	106
Dosatore	213
Espositore per buffet	188
Finger food	110 <> 115
Forchetta aragosta	73
Forchetta monoporzione	73,192
Forchetta per bistecca	71,179
Forchetta per insalata	7 <> 43,69,197
Forchetta per lumache	73
Forchetta servire	7 <> 43,69,197
Forchetta servire pesce	7 <> 43,69,257
Forchettina ostriche	7 <> 43
Forchettina cocktail	73,192
Forchettone	7 <> 43,69,197
Formaggiaria	81,99,108,125,129,142 149,151,152,153,155,159 168,232,236
Fruttiera	139,152,153,155,157

G I L

Glacette termica	218
Golf club mixer spoon	73,214
Grattugia	174
Gueridon d'appoggio	222
Infusiera	195
Insalatiera	78,97,108,248,250
Inserito per finger food	115,184
Lasagnera	142,148,181
Lattiera	82,145,201,202,205,206 207
Legatovaglioli	141,149,235
Legumiera	86,166
Legumiera escoffier	162

M N O

Macine	175
Menage	87,99,108,125,129,142 149,151,152,153,155,158 159,232,236
Mestolo	7 <> 43,69,213
Mini burriera	87,99
Mini casseruola	241
Mini forchetta	73,192
Mini spoon	73,192
Mini vaporiera	115
Mini vassoio	113,188
Misurino cocktail	213
Molla per asparagi	167
Molla per arrosto e verdure	167
Molla per dolci	167
Molla per frutta	167
Molla per ghiaccio	167,214
Molla per lumache	73,167,168
Molla per pane	167
Molla per spaghetti	167
Molla per zucchero	167,203
Mug	249
Numero da tavola	85,97,144,170,173

Indice

	Pag
Oliera	87,99,108,125,129,142 149,151,152,153,155,158 159,232,236
P Q R	
Padella	241,243
Pala per torta	7 <> 43 69,197
Pentola	241,243
Petit marmite	196,198
Piano milleusi	232
Piastra ad induzione ed elettrica	196
Piastra eutettica	274 < > 279
Piattino per burro	154,157
Piattino per lumache	168
Piattino per mug	249
Piattino per pane	101,157,232
Piattino porta monete	137,213
Piattino sottocoppa	98
Piatto da presentazione	101,103,124,128,140,147 153,154,156,171,184,231 232,235,254
Piatto da torta	80,92,138
Piatto ovale	161,162
Piatto per legumi	162
Piatto per ostriche	85,118,119,120,143
Piatto pesce	121,161
Piatto quadrato	80,180
Piatto rotondo	161,162
Piatto termico	165
Pietra ollare	178
Pinza aragosta	73
Pinza per antipasti e dolci	167
Pinza per dolci	167
Pinza per servire	167
Pinza per torta	167
Pinza per verdure	167
Pirofile e porcellane	143,148,181
Porta badge	173
Porta bastoncini di zucchero	208
Porta bicchieri	143,149
Porta bottiglie	169,171
Porta burro e marmellata	87,99,169
Porta bustine da zucchero	82,96,139,208,209
Porta cannuce	214
Porta chiavi	142
Porta condimenti	129,143,152,169,172
Porta cucchiaini	213
Porta gioie	184
Porta grissini	103,171
Porta macarons	81,157
Porta marmellata	87,159
Porta menù	85,97
Porta numero	85,97,144,170,173
Porta pane porta grissini	103,171
Porta pasticcini	78,79,89,129,139,156,184
Porta patatine fritte	170,178
Porta salatini	81,248,249
Porta salse	172
Porta salviettine	209
Porta sapone	209
Porta sigari	106
Porta spazzolini	213
Porta spezie	142,148
Porta stuzzicadenti	81,158,173
Porta toast	170
Porta tovaglioli	96,140,148,171,208
Porta uovo	169
Porta vivande	196,198
Portaghiaccio termico	94,135,217,218,219,220
Posacenere	103,106,168
Posate	7 <> 43,250,256 <> 259
Presentoire	83,89
Quarta posata	62 <> 65,115
Rechaud	196,198
Rinfresca macedonia	85
Rinfrescatore per yogurt	85,199
Rinfrescavino bianco	218,219
Risottiera	143,148
S	
Salsiera	166

	Pag
Scaldacaffè	197
Scaldavivande	196,198
Schiaccianoci	174
Scodella lavadita	168
Secchiello per ghiaccio	84,94,104,105,135,213,21 4215,216,217,218,219,220 221,222,223,228,233,254
Secchiello per ghiaccio termico	94,135,217,218,219,220
Secchiello per spumante	84,94,104,105,135,213,21 4215,216,217,218,219,220 221,222,223,225,228,233 254
Segnaposto	144,170
Servizio per antipasto	81
Servizio per caffè	86,203
Servizio per caviale	98
Servizio per champagne	219
Servizio per latte macchiato	209
Servizio per olio e aceto	87,99,158,159
Servizio per pinzimonio	181
Servizio per zucchero	87,156,203
Set impilabile	248,249
Set per ceviche	173
Set sale e pepe	87,99,106,158,159,166
Shaker	213
Sottobicchiere	131,133,140,147,154,157
Sottobottiglia	131,133,140,147,154,157 235
Sottopiatto	101,103,124,128,131,133 140,147,153,154,156,171 184,231,232,235,254
Spargipepe	99,106,158,166
Spargisale	81,87,99,106,158,159,166 232
Spumantiera	215,225,228
Stiletto aragosta	73
Street cover	131,133
Supporto	180,181
Supporto numero da tavola	85,97,144,170,173
Supporto secchiello spumante/vino	84,94,95,105,123,135,216 217,218,219,220,221,223
T V W Z	
Taglia tartufi	175
Targhette	85,97,144,170,173
Tazza	249
Tegame	241,243
Tegamino friggiuova	168
Teiera	82,145,201,202,205,206 207
Teiera termica	205
Tovaglietta americana	124,128,131,133,184
Vasetto portafiori	140,170
Vassoio	77,80,90,91,92,96,97,101 102,103,113,115,119,124 125,128,129,136,137,143 147,149,151,152,153,154 162,163,171,172,184,192 197,208,231,235,247,250
Vassoio concavo	171
Vassoio conto	103,137
Vassoio gn	77,90
Vassoio ovale	80,92,101,102,113,119,153 231,235
Vassoio quadrato	91,102,113,115,124,125 128,129,136,147,152,184
Vassoio rettangolare	77,90,91,92,96,97,102,113 124,125,128,129,136,137 147,151,152,153,154,162 163,171,172,184,192,197 208,250
Vassoio rotondo	77,91,92,103,143,147,149 151,154,192,247
Versatore per profumo	87
Versavino	169,199
Vetrina refrigerata	274 <> 279
Wok	243
Zuccheriera	82,106,145,201,202,205 206,207,208,209
Zuppiera	86,166,196,198

Index

A B

	Page
Accessories	73
Afternoon tea stand	83
Amenities tray	77,90,91,101,102,124,128 137,152,154,161,163,184 231,235
Asparagus tongs	167
Bar spoon	73,214
Beverage server	195,250
Beverage server, insulated	201,202
Big wine party tub	215,225,228
Boston shaker	213
Bottle cooler	218
Bottle opener	174
Bottle stand/coaster	131,133,140,147,154,157 235
Bowl	96,97,101,102,103,104 105,107,118,119,123,138 152,153,155,157,172,188 231,235,247
Bowl, small	78,97,123,138,169
Bread basket	80,96,138,149,151 152,155,235
Bread plate	101,157,232
Bread stand	96
Bread/Pastry tongs	167
Buffet rack	248,249
Buffet showcase, cooled	274 <> 279
Butter cup	81,98

C

Café au lait set	86,203
Cake server	7 <> 43 69,197,257
Cake stand	80,92,138
Candlestick	83,89,144,199
Carving fork	7 <> 43,69,197,257
Cash tray	137,213
Caviar cup	81,98
Caviar set	98
Caviar spoon	174
Casserole	241,243
Centerpiece	107,118,119,121,138,188 236
Ceviche set	173
Chafing dish	196,198
Champagne bucket	215,225,228
Champagne holder	199
Charger	101,103,124,128,131,133 140,147,153,154,156,171 184,231,232,235,254
Chillcup	81,98
Chilli mill	175
Chopsticks	67
Chopsticks rest	67
Cigar ash tray	103,168
Cloche	83,86,163,168,173
Cloche for wedding cake stand	86,173
Cocktail measuring cup double	213
Cocktail strainer	174
Coffee cup	249
Coffee Design Kit	211
Coffee dispenser solid alcohol heating	197
Coffee pot	82,145,201,202,205,206 207
Coffee pot, insulated	201,202,205
Coffee urn	197
Cookware	241,243
Cooled juice pitcher	201,202
Cork screwer	174
Cover	86,108,161,162,166
Cover for oval meat dish	162
Cover for soup tureen and vegetable dish	86,166
Creamer	106,180,209
Cruet	81,108,158,159,178,232
Cruet set	87,99,108,125,129,142 149,151,152,153,155,158 159,232,236
Cup with feet	80,85,89,213

DEF

Dish cover	161,162,163
Dome cover for dish	83,86,163,168,173

Page

Egg cup	169
Electric heating unit	196
Escargot fork	73
Escargot plate	168
Escargot tongs	73,167,168
Eutectic pads	274 < > 279
Finger bowl	168
Finger food	110 <> 115
Finger food insert	115,184
Fish dish	121,161
Fish serving fork	7 <> 43,69,257
Fish serving knife	7 <> 43,69,257
Flatware	7 <> 43,250,256 <> 259
Flower vase	140,170
Food pan	196,198
Fork, roast	71,179
Fruit basket	107,139,152,153,155,157
Fruit bowl	96,97,104,155,188,223 231,235
Fruit salad bowl	78,97,108,248,250
Fruit stand	78,79,82,93,139,156
Fruit tongs	167
Frying pan	241,243
Frying pan for eggs	168

G H I

Giant champagne bucket	215,225,228
Glass	106,192,247,251,254
Glass coaster	131,133,140,147,154,157
Golf club mixer spoon	73,214
Grated cheese pot	81,99,108,125,129,142 149,151,152,153,155,159 168,232,236
Grater	174
Gravy boat	166
Gueridon	222
Herbs mill	175
Holder	78,79,82,83,85,93,96,118 119,120,138,139,143,156
Hors d'oeuvre tray	142,143,148,151,153,155 180,231,236
Hors d'oeuvre and pastry pliers	167
Ice bucket	84,94,104,105,135,213,214 215,216,217,218,219,220 221,222,223,228,233,254
Ice bucket, insulated	94,135,217,218,219,220
Ice cream cup	98,172,251
Ice tea spoon	7 <> 43
Ice tongs	167,214
Intermezzo cup	170
Infuser jug	195
Induction cooker	196

J K L

Jam and honey holder	87,159
Jug	195,203,250
Juice dispenser	197
Knife rest	73,197
Knives	7 <> 43,71,72,73,120,179
Ladle	7 <> 43,69,213,257
LED Ice cubes	229
Lobster cracker	73
Lobster pick	73

M N

Meat dish	161
Milk dispenser	197
Milk pot	82,145,201,202,205,206 207
Mini butter dish	87,99
Mini casserole	241
Mini fork	73,192
Mini spoon	73,192
Mini steamer	115
Mini table stand	173
Mini tray	113,188
Mixing glass	213
Monoportion fork	73,192
Monoportion spoon	69,73,192
Mug	249
Multipurpose bowl	80,138

Index

	Page
Napkin holder	96,140,148,171,208
Napkin ring	141,149,235
Nut-cracker	174
O P	
Oil and vinegar set	87,99,108,125,129,142 149,151,152,153,155,158 159,232,236
Oil pourer	81,108,158,159,178,232
Oval meat dish	161
Oval dish/china	181
Oyster fork	7 <> 43
Oyster knife	120
Oyster plate	85,118,119,120,143
Parmesan spoon	7 <> 43
Party forks	73,192
Party spoons	7 <> 43
Pastry pliers	167
Pastry stand	79,82,139,156
Paté holder	87,99,169
Pepper grinder	175
Pepper shaker	99,106,158,166
Perfume drops dispenser	87
Petit four stand	78,80,82,92,136,139,156
Petit marmite	196,198
Pie pliers	167
Pinzimonio set	181
Plate cover, round	161,162,163
Plates	85,97,144,170,173
Pliers	73,167,168,203,214
Polycarbonate drinkware	247 <> 251
Porcelain insert	143,148,181
Presentoire	83,89
Punch bowl	89,213
R S	
Relish dish	81,248,249
Room service system	165
Salad bowl	78,97,108,248,250
Salt and pepper set	81,87,99,106,158,159,166 232
Salt cellar	81,87,99,106,158,159,166 232
Salt grinder	175
Salt shaker	81,87,99,106,158,159,166 232
Salt spoon	73,192
Salt/Pepper dispenser	81,87,99,106,158,159,166 232
Sauce boat	166
Sauce bowl	172
Sauce spoon	7 <> 43,257
Saucepan	241,243
Saucer	131,133,140,147,154,157
Seafood stand	85,93,118,119,120,143
Serving fork	7 <> 43,69,197,257
Serving pliers	167
Serving spoon	7 <> 43,69,73,197,257
Set for Risotti	143,148
Shaker	213
Show plate	101,103,124,128,131,133 140,147,153,154,156,171 184,231,232,235,254
Small spoon	73,192
Snack server	81,248,249
Soapstone	178
Soap tray	209
Soup cup	98,166
Soup tureen	86,166,196,198
Spaghetti tongs	167
Square tray	91,102,113,115,124,125 128,129,136,147,152,184
Stackable tray	90,91
Stock pot	241,243
Street cover	131,133
Sugar bowl	82,106,145,201,202,205 206,207,208,209
Sugar, milk and coffee set	86,203
Sugar set	87,156,203
Sugar tongs	167,203
Sugar/Tea bags holder	82,96,139,208,209

	Page
Supreme cup	81,98
T	
Table grill	115,178
Table mat	124,128,131,133,184
Table number	85,97,144,170,173
Table number stand	85,97,144,170,173
Tall container	213
Tea cup	249
Tea pot	82,145,201,202,205,206 207
Tea pot, insulated	205
Thermal serving unit	181
Toast rack	170
Toast/Pastry tongs	167
Tongs	73,167,168,203,214
Toothpick holder	81,158,173
Tray	77,80,90,91,92,96,97,101 102,103,113,115,119,124 125,128,129,136,137,143 147,149,151,152,153,154 162,163,171,172,184,192 197,208,231,235,247,250
Tray gn	77,90
Tray, oval	80,92,101,102,113,119,153 231,235
Tray, rectangular	77,90,91,92,96,97,102,113 124,125,128,129,136,137 147,151,152,153,154,162 163,171,172,184,192,197 208,250
Tray, round	77,91,92,103,143,147,149 151,154,192,247
Tray, square	91,102,113,115,124,125 128,129,136,147,152,184
Trolley	261 <> 272,280 <> 288
Truffle slicer	175
U V W Y	
Underliner	98
Vacuum jug	201,202
Vase	254
Vegetable dish	86,162,166
Vegetable dish escoffier	162
Vegetable/Meat tongs	167
Vegetable pliers	167
Vichyssoise cup	98,166
Vinegar dispenser	81,108,158,159,178,232
Water pitcher	195,206,250
Water pitcher, insulated	201,202
Wine cooler	84,94,104,105,135,213,21 4215,216,217,218,219,220 221,222,223,225,228,233 254
Wine cooler stand	84,94,95,105,123,135,216 217,218,219,220,221,223
Wine holder	169
Wok	243
Yogurt cooler	199

Index

A B

	Page
Accessoires	73
Ardoise	178
Batteries de cuisine	241,243
Beurrir	81,87,98,99,169
Bol	96,97,101,102,103,104
	105,107,118,119,123,138
	152,153,155,157,172,188
	231,235,247
Bol à caviar	81,98
Bol à champagne	215,225,228
Bol à punch	89,213
Bol à rafraichir	118,119,199
Bol à salade de fruits	78,97,108,248,250
Bol à sauce	166
Bol à snacks	81,248,249
Bol avec socle	80,85,89,213
Bol en bois	123
Bol en polycarbonate	246<>250
Bol en polypropylène	254
Bol en verre	80,108
Bol universel	80,138
Boston shaker	213
Bouilleur	197
Borne étouffoir	106
Brasier avec pierres naturelles	115,178
Brasière	241,243
But de canapé	222

C

Cache eau mineral	171
Cafetière	82,145,201,202,205,206
	207
Cafetière thermique	201,202,205
Carafe	195,206,252
Carafe à eau	195,201,202,206,250
Carafe à eau thermique	201,202
Cartouches eutectiques	274 < > 279
Casse-noix	174
Cendrier	103,106,168
Cendrier à cigares	103,106,168
Centre de table/Compotier	107,118,119,121,138,188
	236
Chafing-dish	196,198
Chandelier	83,89,144,199
Chandelier/bougeoir	89,144
Chariot	261 <> 272,280 <> 288
Chariot de service	91
Chopsticks	67
Cloche pour plat	83,86,163,168,173
Cloche pour plat ovale	163
Cloche pour plat rond	83,86,163,168,173
Cloche support à tartes	86,173
Coffe Design Kit	211
Coffee Urn	197
Conteneur à thé	96,139,208,209
Coquetier	169
Corbeille	96,97,101,102,103,104
	105,118,119,123,138,152
	153,155,157,172,188,231
	235,247
Corbeille à pain	80,96,138,149,151,152
	155,235
Corbeille pour aromatiques condiments	129,143,152,169,172
Corps de chauffe électrique	196
Coupe à beurre	81,98
Coupe à caviar	81,98
Coupe à creme/potage	166
Coupe à crevettes	81,98
Coupe à fruits	98,172,251
Coupe à glace	98,172,251
Coupe à intermezzo	170
Coupe à Martini	170,251
Coupe à punch	89,213
Coupe à suprême	81,98
Coupe à vichyssoise	98,166
Coupe multifonctions	80,138
Coupe sur pied	80,85,89,213
Coupe thermique à glace	172
Coupelle	78,80,81,98,108,138,169
	172,223,248,249,250,254
Coupe-truffes	175

Page

Couteau à huîtres	120
Couteau à servir poisson	7 <> 43,69
Couteaux	7 <> 43,71,72,73,120,179
Couvercle	86,108,161,162,166
Couvercle légumier	86,166
Couverts	7 <> 43,250,256 <> 259
Couvre-plat	161,162,163
Crémier	106,180,209
Cuiller à bar	73,214
Cuiller à risotto	69,73,197
Cuiller à servir	7 <> 43,69,73,197,257
Cuiller à soda	7 <> 43
Cuillère cocktail	73,214
Cuillère à glace	7 <> 43
Cuillère à parmesan	7 <> 43
Cuillère à sauce	7 <> 43,257
Cuillère à sel	73,192
Cuillère monoportion	69,73,192
Curette à homard	73

D E F

Décapsuleur	174
Distributeur à jus	197
Distributeur à lait	197
Distributeur de serviettes	96,140,148,171,208
Doseur	213
Douser sel/poivre	81,87,99,106,158,159,166
	232
Ecuelle	168
Etagère	188,248,249
Étiquettes	85,97,144,170,173
Faitout	241,243
Finger food	110 <> 115
Fourchette amuse-bouche	73,192
Fourchette à béquille	71,179
Fourchette à escargots	73
Fourchette à fromage	73
Fourchette à huîtres	7 <> 43
Fourchette à rôtis	71,179
Fourchette à servir	7 <> 43,69,197,257
Fourchette à servir poisson	7 <> 43,69,257
Fourchette cocktail	73,192
Fourchette langouste	73
Fourchette monoportion	73,192
Fromagère	81,99,108,125,129,142
	149,151,152,153,155,159
	168,232,236

G H I L

Glacette thermique	218
Glaçon lumineux	229
Golf crosse pour cocktail	73,214
Huilier	81,108,158,159,178,232
Huilier/vinaigrier	87,99,108,125,129,142
	149,151,152,153,155,158
	159,232,236
Légumier	86,166
Légumier escoffier	162
Louche	7 <> 43,69,213

M N O

Marmite traiteur	241,243
Ménagère	87,99,108,125,129,142
	149,151,152,153,155,158
	159,232,236
Mesure à alcool, double	213
Mini faitoute	241
Mini marquer de table	173
Mini spoon	73,192
Mini plateau	113,188
Mini vaporisateur	115
Moulin à herbes	175
Moulin à piment	175
Moulin à poivre	175
Moulin à sel	175
Mug	249
Numéro de table	85,97,144,170,173
Ouvre boîte	174
Ouvre-bouteilles	174

Index

P Q

	Page
Panier à fruits	107, 139, 152, 153, 155, 157
Passoire à cocktail	174
Pelle à gâteau / à tarte	7 <> 43 69, 197, 257
Petit sous-plat	131, 133, 140, 147, 154, 157 235
Petite marmite	196, 198
Pied pour seau à champagne	84, 94, 95, 105, 123, 135, 216 217, 218, 219, 220, 221, 223
Pince	73, 167, 168, 203, 214
Pince à asperges	167
Pince à fruits	167
Pince à glace	167, 214
Pince à homard	73
Pince à hors-d'oeuvres et pâtisserie	167
Pince à légumes	167
Pince à pain et pâtisserie	167
Pince à pâtisserie	167
Pince à rôti	167
Pince à servir	167
Pince à spaghetti	167
Pince à sucre	167, 203
Pince à tarte	167
Pince à toast et tarte	167
Plaque à induction	196
Plat à escargots	168
Plat à huîtres	85, 118, 119, 120, 143
Plat à pain	101, 157, 232
Plat à poisson	121, 161
Plat à présentation	101, 103, 124, 128, 140, 147 153, 154, 156, 171, 184, 231 232, 235, 254
Plat oval	161, 162
Plat rond	161, 162
Plateau	77, 80, 90, 91, 92, 96, 97, 101 102, 103, 113, 115, 119, 124 125, 128, 129, 136, 137, 143 147, 149, 151, 152, 153, 154 162, 163, 171, 172, 184, 192 197, 208, 231, 235, 247, 250
Plateau à hors d'oeuvre	142, 143, 148, 151, 153, 155 180, 231, 236
Plateau à monnaie	137, 213
Plateau carré	91, 102, 113, 115, 124, 125 128, 129, 136, 147, 152, 184
Plateau gn	77, 90
Plateau ovale	80, 92, 101, 102, 113, 119, 153 231, 235
Plateau rond	77, 91, 92, 103, 143, 147, 149 151, 154, 192, 247
Plateau, rectangulaire	77, 90, 91, 92, 96, 97, 102, 113 124, 125, 128, 129, 136, 137 147, 151, 152, 153, 154, 162 163, 171, 172, 184, 192, 197 208, 250
Poêle	241, 243
Poivrier	99, 106, 158, 166
Porcelaine	143, 148, 181
Porte brosse à dents	213
Porte confitures	87, 159
Porte cure-dents	81, 158, 173
Porte gobelets	143, 149
Porte gressin	103, 171
Porte macarons	81, 157
Porte petits fours	78, 79, 82, 93, 139, 156, 184
Porte pommes frites	170, 178
Porte savon	209
Porte serviette	209
Porte-appetizers	81, 248, 249
Porte-badge	173
Porte-bouteille	169, 171
Porte-pate/beurre/caviar	87, 99, 169
Porte toast	170
Pot à cuillères	213
Pot à lait	82, 145, 201, 202, 205, 206 207
Pot à sucre	82, 96, 139, 208, 209
Presentoire	83, 89
Quarta Posata	62 <> 65, 115

R S

Rafraichisseur à bouteille	218
----------------------------	-----

Page

Rafraichissoir à yogourt	199
Ravier à parmesan	81, 99, 108, 125, 129, 142 149, 151, 152, 153, 155, 159 168, 232, 236
Rechaud à cafe	197
Reibe	174
Rince doigts	168
S	
Saladier	78, 97, 108, 248, 250
Salière	81, 87, 99, 106, 158, 159, 166 232
Saucière	166
Seau à champagne	84, 94, 104, 105, 135, 213, 21 4215, 216, 217, 218, 219, 220 221, 222, 223, 225, 228, 233 254
Seau à glace	84, 94, 104, 105, 135, 213, 21 4215, 216, 217, 218, 219, 220 221, 222, 223, 228, 233, 254
Seau à glace, thermique	94, 135, 217, 218, 219, 220
Seau à vin	84, 94, 104, 105, 135, 213, 21 4215, 216, 217, 218, 219, 220 221, 222, 223, 225, 228, 233 254
Service à caviar	98
Set de table	124, 128, 131, 133, 184
Set pinzimonio	181
Set pour ceviche	173
Set salière, poivrier	81, 87, 99, 106, 158, 159, 166 232
Shaker	213
Soliflore	140, 170
Soupière avec couvercle	86, 166, 196, 198
Sous plat	101, 103, 124, 128, 131, 133 140, 147, 153, 154, 156, 171 184, 231, 232, 235, 254
Sous verre	131, 133, 140, 147, 154, 157
Sous-bouteille	131, 133, 140, 147, 154, 157 235
Street Cover	131, 133
Sucrier	82, 106, 145, 201, 202, 205 206, 207, 208, 209
Support	180, 181
Support à tarte	80, 92, 138
Support avec numéro de table	85, 97, 144, 170, 173
Support pour seau à champagne / à vin	84, 94, 95, 105, 123, 135, 216 217, 218, 219, 220, 221, 223
Support pour toast	170
T V W	
Tasse	249
Théière	82, 145, 201, 202, 205, 206 207
Théière thermique	205
Tire-bouchon	174
Vase à fleurs	140, 170
Verre	106, 192, 247, 251, 254
Verseur de parfum en gouttes	87
Vinaigre	81, 108, 158, 159, 178, 232
Vitrine réfrigérée	274 <> 279
Wok	243

Alphabetisches Register

A B C	Seite
Ascher	103,106,168
Ascherständer	106
Auflaufform auf Porzellan	181
Austernöffner	120
Badge-Halter	173
Bargestell	248,249
Beilagenschale	168
Bierbecher	251
Blumenvase	140,170
Bonbonsschale	155
Boston Shaker	213
Bowlenlöffel	213
Bratenplatte	161
Bratentopf	241,243
Bratpfanne	241,243
Brot Platte	101,157,232
Brotkorb	80,96,139,149,151,152 155,235
Brottschale	101,103,149,157,232
Buffet Display	188,192
Buffet-Tablett	92,192,247
Butterdose	169
Butterkühler	154,157
Café au Lait-Set	86,203
Cappuccinolöffel	209
Cevichese	173
Chafing dish	196,198
Chafing dish besteck	197
Champagner Bowl	85,95,104,215,225,228
Champagnerflaschenhalter	199
Champagnerglas	192,251
Chilimühle	175
Chillcup	81,98
Cocktailsieb	174
Coffee Urn	197

D E F	
Deckel	86,108,161,162,166
Dessertgestell	83
Dressingbehälter	106,166,180,201,202 203,209
Dressinglöffel	7 <> 43,257
Eierbecher-Set	169
Eierlöffel	7 <> 43
Eierpfanne	168
Einsatz Tablett	115,125,128,184
Eisbecher	251
Eisfruchtbecher, Isoliert	172
Eisgefäß	84,94,104,105,135,213,214 215,216,217,218,219,220 221,222,223,228,233,254
Eisgefäß, Isoliert	94,135,217,218,219,220
Eislöffel	7 <> 43
Eisschale	98,172,251
Eisschaufel	7 <> 43
Eiswasserkrug	195,206,250
Eiswürfel LED	229
Eiszange	167,214
Essig-/Ölflasche	81,108,158,159,178,232
Essig-/Ölflaschenhalter	123,129,143,169,172
Essig-/Ölgestell	87,99,108,142,149,151, 152,153,155,158,159,232 236
Essig-/Öl-Menage	125,129
Ess-Stäbchen Paar	67
Ess-Stäbchen Ablage	67
Etagère	78,79,93,107,139,156
Feuerschale	115,178
Fingerfood-/Vorspeisen-/Butter-Gefäß	138
Fingerschale	168
Fischplatte	161
Flaschenhalter	171
Flaschenteller	131,133,140,147,154,157 235
Fleischgabel	71,179
Früchtekorb	104,105,123,151,223,248
Frühstück Tablett	125,128

G H K	
Gebäckplatte	163
Gebäck- und Servierzange	167

	Seite
Gemüsetopf	241,243
Getränkekühler	218,219
Gewürzmenage	159
Gewürzständer	142,148
Glas	106,192,247,251,254
Glassflasche	108
Glaskrug	195
Glasschale	80,108
Glasuntersatz	131,133,140,147,154,157
Golf Schlegler	73,214
Gratinplatte	162,163
Griffschale	101,231,235
Grifftablett	101,231,235
Grill Pfanne	243
Grissini-Halter	103,107,171
Gueridon	222
Happy Spoon	69
Heizelement	196
Hummergabel	73
Hummerzange	73
Kaffeekanne	82,145,201,202,205,206 207
Kaffeekanne, isoliert	201
Kaffeespender	197
Kaffeetablett	208
Kartenhalter	85,97,170
Kartoffenbehälter	170,178
Kartoffellöffel	7 <> 43
Kasserolle	243
Kaviarkühler	81,98
Kaviarlöffel	174
Kaviarschale	81,98
Korkenheber	174
Korkenzieher	174
Kuchen-/Tortenplatte	80,92,136,138
Käsedose	81,99,108,125,129,142 149,151,152,153,155,159 168,232,236
Käsemesser	73
Kühlschale	118,119
Kühlvitrine	274 <> 279

L M N	
Latte Macchiato-Set	209
Légumier	86,166,196,198
Leuchter	83,89,144,199
Löffelbecher	213
Macaronsträger	81,157
Marmeladegestell	87,159
Martini Glass	170,251
Milchdispenser	197
Milchkaffee-Set	211
Milchkanne	82,145,201,202,205,206 207
Milchkännchen	106,180,203,209
Milch-Kaffee-Zucker-Set	86,203
Mini Bratentopf	241
Mini Butterdose	87,99
Mini Gabel	192
Mini Spoon	192
Mini Tablett	113,186
Mini Verdampfer	115
Mokkaétagère	79,89,139,156
Mug	249
Nussknacker	174
Nussschale	157

O P Q	
Obstschale	78,80,82,92,97,101,102 103,107,118,119,121,138 151,152,153,155,157,172 188,231,247,250,254
Papierbecherständer	143,149
Pâtisserie Tablett	208,235
Petits Fours-Ständer	78,80,82,92,136,139,156
Pfeffermühle	175
Pfefferstreuer	99,106,158,166
Platten	80,161,162,180,188
Platzteller	101,103,124,128,131,133 140,147,153,154,156,171 184,231,232,235,254

Alphabetisches Register

	Seite
Portionsschöpfer	7 <> 43
Porzellanschale	143,148,181
Presentoire	83,89
Punchbowl	89,213
Quarta Posata	62 <> 65,115

R S

Reibe	174
Reislöffel	69,73,197,257
Relish-Pickles-Gestell	81,248,249
Rotweinwiege	169
Saftdispenser	197
Saftkrug	195,250
Sahne-/Zucker-Set	86,87,203
Sahnegießer	106,180,209
Sahnekännchen	203
Salat-/Vorlegebesteck	7 <> 43,197,250
Salatzange	167
Salz- und Pfeffergestell	87,99,158,159,166
Salzmühle	175
Sauce Set	172
Saucenlöffel	7 <> 43,257
Sauciere	166
Schale	96,97,101,102,103,104 105,118,119,123,138,152 153,155,157,172,188,231 235,247
Schalenhalter	180
Schlüsselanhänger	142
Schmuckablage/Bonbonträger	129,184
Schnapsbecher	251
Schneckengabel	73
Schneckenzange	73,167,168
Schneckenplatte	168
Serviergestell	83
Serviertablett	101,103,124,128,140,147 153,154,156,171,184,231 232,235,254
Servierwagen	261 <> 272,280 <> 288
Serviettenhalter	96,140,148,171,208
Serviettenring	141,149,235
Set mit Porzellanschale	142,143,148
Shot Glass	106
Snackschale	169
Sorbetschale	170
Speckstein	178
Speisekartenhalter	85,97
Stand für Plastik Platte	149
Steakbesteck	71,179
Steakmessern	71,179
Stielkasserolle	241
Suppenmarmite	196,198
Suppenschöpfer	7 <> 43,69
Suppenstation	196,198
Suppentasse	166
Suppenterrine	86,166,196,198
Street Cover	131,133
Strohalm Halter	214

T

Tablett	77,80,90,91,92,96,97,101 102,103,113,115,119,124 125,128,129,136,137,143 147,149,151,152,153,154 162,163,171,172,184,192 197,208,231,235,247,25
Tablett Gastronorm	77,90
Tablett für Stoffservietten	209
Tablett, konkave	171
Tablett, oval	80,92,101,102,113,119,1532 31,235
Tablett, quadratisch	91,102,113,115,124,125 128,129,136,147,152,184
Tablett, rechteckig	77,90,91,92,96,97,102,113 124,125,128,129,136,137 147,151,152,153,154,162 163,171,172,184,192,197 208,250
Tablett, rund	77,91,92,103,143,147,149 151,154,192,247
Tafelaufsatz	107,118,119,121,138,188

Seite

Teeglas	236
Teekanne	188
	82,145,201,202,205,206
	207
Teekanne, Isoliert	205
Teller	161
Tellercloche	83,86,163,168,173
Thermische Ringröhre	181
Tischnummer	144,170,173
Tischnummernständer	85,97,144,170
Tischnummern-Aufsteller	97,170
Tischrestebehälter	214
Tischset	124,128,131,133,184
Toastständer	170
Tortenheber	7 <> 43 69,197
Tranchiergabel	71,179
Tranchiermesser	71,72,179
Tropf-Parfüm Aussteller	87
Trüffel Hobel	175

U V W Y

Universalschale	80,123,138
Vorlege-/ Aufschnittgabel	73,192
Vorspeisenplatte	142,143,148,151,153,155 180,231,236
Yogurtkühler	85,199
Warmhalteteller	165
Wasserascher	85,97,103
Weinbecher	251
Wein-/Sektkühler	84,94,104,105,135,213,21 4 215,216,217,218,219,220 221,222,223,225,228,233
	254
Weinkühler	218,219
Weinkühlerständer	84,94,95,105,123,135,216 217,218,219,220,221,223
Whisky Becher	251
Wokpfanne	243

Z

Zahlteiler	213
Zahnstocherbehälter	81,158,173
Zuckerdose	82,106,145,201,202,205 206,207,208,209
Zuckergestell	87,156,203
Zuckerständer	156
Zuckerstangengefäß	82,96,139,208,209
Zuckerzange	167,203

Indice

A B

	Pág.
Abrebotellas	174
Accesorios	73
Aceitera	81,108,158,159,178,232
Apoyo para chopsticks	67
Apoyo para cubiertos	73,197
Azucarera	82,96,139,208,209
Azucarero	82,106,145,201,202,205 206,207,208,209
Bac rond	143,148
Bajo plato	101,103,124,128,131,133 140,147,153,154,156,171 184,231,232,235,254
Bandeja	77,80,90,91,92,96,97,101 102,103,113,115,119,124 125,128,129,136,137,143 147,149,151,152,153,154 162,163,171,172,184,192 197,208,231,235,247,250
Bandeja concavo	171
Bandeja cuadrada	91,102,113,115,124,125 128,129,136,147,152,184
Bandeja cuentas y propinas	137,213
Bandeja gn	77,90
Bandeja portaservilletas	209
Bandeja rectangular	77,90,91,92,96,97,102,113 124,125,128,129,136,137 147,151,152,153,154,162 163,171,172,184,192,197 208,250
Bandeja redonda	77,91,92,103,143,147,149 151,154,192,247
Bandeja tartas	80,92,138
Baterias de cocina & accesorios	241,243
Bistequera	243
Bobina térmica	181
Bol à salade de fruits	85
Bol para caviar	81,98
Bol para limpiar dedos	168
Botella	108

C

Cacerola	241,243
Cafetera	82,145,201,202,205,206 207
Cafetera térmica	201,202,205
Calentador de café	197
Calentador à inducción	196
Calentador eléctrico	196
Candelabro	83,89,144,199
Carros	261 <> 272,280 <> 288
Cascanueces	174
Cazo	7 <> 43,69,213
Cenicero	103,106,168
Cenicero a columna	106
Centro mesa	107,118,119,121,138,188 236
Cesta pan	80,96,103,138,149,151 152,155,235
Cesta para fruta	107,139,152,153,155,157
Cesto por aromaticos y condimentos	129,143,152,169,172
Cevichera	173
Chafing-dish	196,198
Chop sticks	67
Coctelera	213
Coctelera con vaso	213
Coffee Design Kit	211
Colador para cóctel	174
Columna porta cubo champany	84,94,95,105,123,135,216 217,218,219,220,221,223
Contenedor para café	197
Contenedor para zumo de fruta	197
Contenedor sobres té	82,96,139,208,209
Copa caviar	81,98
Copa cóctel camarones	81,98
Copa con base	80,85,89,213
Copa de vidrio	80,108
Copa gazpacho/potage	166
Copa helado y macedonia	98,172,251
Copa mantequilla	81,98
Copa para intermezzo	170
Copa salsa	166

Pág.

Copa soufflé	166
Copa térmica	172
Copa universal	80,138
Copa vichyssoise	98,166
Copita	78,80,81,98,108,138,169
Cortador de trufas	175
Cuberteria	7 <> 43,250,256 <> 259
Cubitera de champaña	215,225,228
Cubitera hielo	84,94,104,105,135,213,214 215,216,217,218,219,220 221,222,223,228,233,254
Cubitera hielo térmica	94,135,217,218,219,220
Cubito hielo LED	229
Cubo de champagne gigante	95,215,225,228
Cubo vino	84,94,104,105,135,213,214 215,216,217,218,219,220 221,222,223,225,228,233 254
Cubreplatos ovales	162,163
Cubreplatos, redondo	161,162,163
Cuchara arroz	69,73,197
Cuchara cocktail	7 <> 43
Cuchara ensalada	7 <> 43,69,197
Cuchara parmesán	7 <> 43
Cuchara servir	7 <> 43,69,73,197
Cucharita cappuccino	209
Cucharita caviar	174
Cucharita mezcladora	73,214
Cucharita para sal	73,192
Cuchillo ostras	120
Cuchillo servir pescado	7 <> 43,69
Cuchillos	7 <> 43,71,72,73,120,179
Cúpula cubre-plateos	83,86,163,168,173
Cuenco	78,97,101,102,103,108,123 138,139,149,169,188,231 235,247,248,249,250,254
Cuenco con pedestal	80,97
Cúpula refrigerada	274 <> 279

D E F

Dispensador	188
Dosador sal/pimienta	81,87,99,106,158,159,166 232
Ensaladera	78,97,108,248,250
Entremesera	142,143,148,151,153,155 180,231,236
Finger Food	110 <> 115
Florero	140,170
Frutero	78,79,82,93,139,156
Fuente de marisco	85,118,119,120,143
Fuente oval	161,162
Fuente para Lasagne	142,148,181
Fuente pescado	121,161

G H J I L

Golf club cucharita coctél	73,214
Gueridon	222
Hoguera con piedras naturales	115,178
Huevera	169
Jarra	203
Jarra agua	195,250
Jarra leche	82,145,201,202,205,206 207
Jarra térmica	201,202
Jarrita lechera	106,180,209
Joyero	184
Juego azucar	87,203
Juego café au lait	86,203
Juego leche, café y azucar	86,203
Individual en madera	124,128,184
Individual en goma	131,133
Inserto por finger food	115,184
Lavadodos	168
Legumbreira	86,166
Legumbreira escoffier	162

M N O

Mantel individual	124,128,131,133,184
Mantequillera	87,99,169
Marmeladero	87,159,169
Medida bar, doble	213

Indice

	Pág.
Mini bandeja	113,188
Mini cacerola	241
Mini spoon	73,192
Mini tenedor	73,192
Mini vaporizador	115
Molinillo chile	175
Molinillo hierbas	175
Molinillo pimienta	175
Molinillo sal	175
Mug	249
Número de mesa	85,97,144,170,173
P Q	
Pala para tarta	7 <> 43 69,197
Pala pescado	7 <> 43,69
Palillero	81,158,173
Panera	80,96,138,149,151,152 155,235
Pedestal para tarta	80,92,138
Petit marmite	196,198
Pimentero	99,106,158,166
Pinza asados y verduras	167
Pinza azucar	167,203
Pinza caracoles	73,167,168
Pinza entremeses y pasteles	167
Pinza espagueti	167
Pinza espárragos	167
Pinza frutas	167
Pinza hielo	167,214
Pinza pan y pasteles	167
Pinza pasteles	167
Pinza pasteles y tostadas	167
Pinza servir	167
Pinza verduras	167
Pinzimonio	181
Pizarra	178
Plancha refrigerada	274 < > 279
Platillo para mantequilla	87,99
Platito bajo botellas	131,133,140,147,154,157 235
Platito bajo vasos	131,133,140,147,154,157
Plato caracoles	168
Plato de presentación	101,103,124,128,140,147 153,154,156,171,184,231 232,235,254
Plato huevos	168
Plato ostras	85,118,119,120,143
Plato para pan	101,157,232
Plato térmico	166
Ponchera	89,213
Porcelana	143,148,181
Porta bastoncillos de pan	103,107,171
Porta botellas	169,171,199
Porta cepillo de dientes	213
Porta cucharitas	213
Porta dulces	78,79,89,129,139,156,184
Porta jabón	209
Porta informaciones	85,97
Porta macaron	81,157
Porta numero de mesa	85,97,144,170,173
Porta palillas	214
Porta patatas fritas	170,178
Porta pescado	85,93,118,119,120,143
Porta servilletas	96,140,148,171,208
Porta tarjeta	173
Porta tostadas	170
Porta vasos	143,149
Portallaves	142
Portapan	103,107,171
Portaplatos de plastica	149
Posabotella	131,133,140,147,154,157 235
Posavaso	131,133,140,147,154,157
Posavaso por mug	249
Presentoire	83,89
Puerto paté/mantequilla/caviar	81,98
Quarta Posata	62 <> 65,115
Quesera	81,99,108,125,129,142 149,151,152,153,155,159 168,232,236

R S	Pág.
Rallador	174
Refrigerador para yogurt	85,199
Rompenueces	174
Salero y pimentero	81,87,99,106,158,159,166 232
Salsera	166
Servicio para buffet	188
Servicio para café con leche	209
Servicio para caviar	98
Servicio para champagne	219
Servicio para ensaladas	181
Servicio para Lasagne	142,148,181
Servicio para salsa	172
Servicio por aromaticos y condimentos	142,148
Servicio por entremes	81,248,249
Servilletero	141,149,235
Sopera	86,166,196,198
Soporte platos	83
Soporte multi usos	180,181
Street cover	131,133
T V W	
Tapa	86,108,161,162,166
Tapa legumbreira y sopera	86,166
Tarjetas	85,97,144,170,173
Tazas	249
Tenedor caracoles	73
Tenedor cocktail	73,192
Tenedor diápasón	71,179
Tenedor ensalada	7 <> 43,69,197
Tenedor langostas	73
Tenedor ostras	7 <> 43
Tenedor pescado	7 <> 43,69
Tenedor servir	7 <> 43,69,197
Tetera	82,145,201,202,205,206 207
Tetera térmica	205
Vaso	106,192,247,251,254
Versador de perfume en gotas	87
Vinagrera	81,108,158,159,178,232
Vinagreras con saleros	87,99,108,125,129,142 149,151,152,153,155,158 159,232,236
Wok	243

Index

Pag		Pag		Pag		Pag		Pag		Pag	
44	73	145	275	264	276	361	205	538	250	602	159
011	261	146	90	265	96	362	205	542	250	603	159
012	261	146GN	90	265	276	363	205	543	251	604	159
013	261	151	197	266	162	364A	205	543N	192	605	248
014	261	151	279	267	162	364B	205	544	169	606	249
015	261	152	279	268	163	364T	205	545	213	607	105
016	261	153	279	269	161	366	205	546	213	608	104
017	261	154	279	270	96	367	205	547	213	609	101
025	174	155	279	271	278	370	221	548	213	609B	231
031	262	161	274	272	165	371	221	549	113	611	159
032	262	162	274	272	278	380	214	549	188	612	101
033	262	163	274	273	165	381	214	549	188	612B	231
034	262	164	151	273	278	382	214	550	249	613	101
035	262	164	274	274	278	406	152	551	213	613B	231
036	262	165	151	275	278	407	152	552	249	614	101
037	262	165	274	280	173	408	152	553	247	614B	231
041	268	166	151	281	173	409	152	554	247	615B	232
042	268	168	151	281	277	410	152	555	247	616AC	101
043	268	169	151	282	115	411	145	555N	192	616B	232
044	268	186	151	282	178	411	152	556	250	616BAC	232
045	268	199	154	282	277	412	145	557	102	617	101
046	268	201	154	283	277	413	145	558	102	617B	231
047	268	202	154	284	277	414	145	558G	119	620	178
047	174	203	154	285	277	438	104	558V	119	621	202
048	174	204	157	287	92	438	215	559	103	622	202
049	174	205	96	288	92	439	104	560	103	623	202
051	265	206	96	289	170	439	215	560	188	624	202
052	265	206	208	289	178	446	170	561	102	624P	202
053	265	208	157	292	156	447	175	562	102	627B	232
054	265	208	157	293	156	448	171	562G	118	630B	231
055	265	209	154	294	156	462	175	562V	118	631	206
056	265	210	154	295	92	464	175	563	102	632	206
057	265	211	163	296	92	466	175	563	188	633	206
071	266	220	89	297	92	473	174	564	102	634	206
072	266	221	269	298	92	485	120	565	108	635	206
076	266	222	269	301	98	497	158	566	108	639	203
077	266	223	269	301A	98	498	99	567	103	641	201
081	267	224	269	301B	98	499	209	568	103	642	201
082	267	225	173	301C	98	500B	280	569	103	643	201
086	267	225	269	302	285	500N	280	570	106	644	201
087	267	229	172	304	159	502	155	570	180	644P	201
091	264	230	172	305	147	503	169	571	106	645	201
092	264	231	161	306	149	504	169	572	108	646	202
093	264	232	171	307	149	504	281	572A	108	647	201
094	264	233	161	308	149	505	152	572	178	648	202
094	172	235	121	308	285	505	281	574	180	649	203
095	264	235G	121	309	148	506	99	575	180	651	207
098	172	235	162	309	285	507	99	576	181	652	207
099	254	236	162	310	149	508	158	577	108	653	207
101	270	236	199	312	148	509	158	578	108	654	207
102	270	238	163	313	147	510	158	579	181	657	85
103	156	241	161	314	171	510B	282	580	181	658	229
103	270	242	107	315	147	510N	282	581	180	660	219
104	270	242G	120	316	147	510ST	158	582	180	661	213
105	157	24202G	120	317	149	511	166	582	181	662	218
105	270	243	161	319	147	512	159	583	181	663	218
106	157	245	163	320	147	513	99	584	108	664	218
106	270	247	83	321	149	514	283	585	108	665	213
107	270	247	163	322	287	514P	106	588	247	666	218
121	263	250	91	323	147	514S	106	588P	192	666A	219
122	263	251	161	324	148	515	283	590	249	666B	123
123	263	252	118	325	148	516	96	591	247	666C	105
124	263	252G	118	327	148	516	208	591P	192	666C	223
125	263	253	163	328	287	517	254	592	249	666E	94
126	263	254	97	329	287	518	96	593	249	666E	220
127	263	255	89	331	153	520	113	594	180	666F	84
131	171	256	91	332	153	520B	284	594	209	666F	216
136	208	257	89	332	286	520N	284	595	209	666G	135
137	91	258	89	333	153	522	155	596	104	666G	217
138	91	259	97	334	153	524	285	596	223	666H	221
139	91	260	178	335	153	525	99	597	105	666I	95
140	91	261	276	336	153	525	285	597	222	666W	222
141	90	262	119	337	153	526	113	598	105	666Z	222
141GN	90	262	276	338	286	527	251	598	222	668	94
141	275	262G	119	339	286	528	168	598	225	668	220
142	275	26202G	120	350	158	530	115	599	104	669	94
143	97	26203G	120	350	232	531	251	599	123	669	220
143	275	26204G	120	352	232	533	251	599	223	670	218
144	90	263	162	354	169	534	251	599	223	671	170
144GN	90	263	276	355	169	535	251	600	250	672	219
144	275	264	162	356	172	536	251	601	159	675	171

Index

Pag	Pag	Pag	Pag	Pag	Pag
<u>675P</u>	<u>171</u>	<u>792</u>	<u>184</u>	<u>902</u>	<u>208</u>
<u>676</u>	<u>218</u>	<u>793</u>	<u>125</u>	<u>903</u>	<u>170</u>
<u>678</u>	<u>219</u>	<u>793</u>	<u>129</u>	<u>904</u>	<u>168</u>
<u>679</u>	<u>219</u>	<u>794</u>	<u>125</u>	<u>905</u>	<u>171</u>
<u>680</u>	<u>219</u>	<u>794</u>	<u>129</u>	<u>905P</u>	<u>171</u>
<u>681</u>	<u>219</u>	<u>795</u>	<u>124</u>	<u>906</u>	<u>67</u>
<u>682</u>	<u>195</u>	<u>795</u>	<u>128</u>	<u>907</u>	<u>97</u>
<u>683</u>	<u>214</u>	<u>795</u>	<u>184</u>	<u>909</u>	<u>105</u>
<u>684</u>	<u>214</u>	<u>796</u>	<u>124</u>	<u>909</u>	<u>228</u>
<u>685</u>	<u>95</u>	<u>796</u>	<u>128</u>	<u>909B</u>	<u>233</u>
<u>685</u>	<u>215</u>	<u>796</u>	<u>184</u>	<u>910</u>	<u>105</u>
<u>686</u>	<u>95</u>	<u>799</u>	<u>123</u>	<u>910</u>	<u>228</u>
<u>686</u>	<u>215</u>	<u>800</u>	<u>136</u>	<u>910B</u>	<u>233</u>
<u>688</u>	<u>104</u>	<u>801</u>	<u>136</u>	<u>911</u>	<u>168</u>
<u>688</u>	<u>215</u>	<u>802</u>	<u>129</u>	<u>912</u>	<u>105</u>
<u>689</u>	<u>104</u>	<u>802</u>	<u>136</u>	<u>912</u>	<u>228</u>
<u>689</u>	<u>215</u>	<u>802</u>	<u>184</u>	<u>912B</u>	<u>233</u>
<u>691</u>	<u>195</u>	<u>802</u>	<u>184</u>	<u>913</u>	<u>173</u>
<u>700</u>	<u>178</u>	<u>803C</u>	<u>211</u>	<u>922</u>	<u>87</u>
<u>700</u>	<u>208</u>	<u>804</u>	<u>123</u>	<u>935</u>	<u>81</u>
<u>701</u>	<u>166</u>	<u>804</u>	<u>129</u>	<u>936</u>	<u>86</u>
<u>702</u>	<u>99</u>	<u>805</u>	<u>137</u>	<u>937</u>	<u>80</u>
<u>703</u>	<u>209</u>	<u>806</u>	<u>137</u>	<u>938</u>	<u>80</u>
<u>704</u>	<u>96</u>	<u>807</u>	<u>136</u>	<u>939</u>	<u>86</u>
<u>704</u>	<u>208</u>	<u>808</u>	<u>136</u>	<u>939</u>	<u>203</u>
<u>706</u>	<u>209</u>	<u>809</u>	<u>136</u>	<u>940</u>	<u>86</u>
<u>707</u>	<u>169</u>	<u>810</u>	<u>137</u>	<u>940</u>	<u>203</u>
<u>708</u>	<u>213</u>	<u>811</u>	<u>142</u>	<u>941</u>	<u>213</u>
<u>709</u>	<u>173</u>	<u>812</u>	<u>142</u>	<u>941</u>	<u>214</u>
<u>710</u>	<u>169</u>	<u>813</u>	<u>140</u>	<u>942</u>	<u>87</u>
<u>711</u>	<u>169</u>	<u>814</u>	<u>140</u>	<u>943</u>	<u>87</u>
<u>712</u>	<u>98</u>	<u>817</u>	<u>142</u>	<u>944</u>	<u>86</u>
<u>713</u>	<u>98</u>	<u>819</u>	<u>143</u>	<u>945</u>	<u>86</u>
<u>714</u>	<u>98</u>	<u>820</u>	<u>143</u>	<u>946</u>	<u>86</u>
<u>715</u>	<u>157</u>	<u>825</u>	<u>142</u>	<u>947</u>	<u>87</u>
<u>716</u>	<u>154</u>	<u>826</u>	<u>138</u>	<u>949</u>	<u>85</u>
<u>719</u>	<u>106</u>	<u>827</u>	<u>138</u>	<u>950</u>	<u>78</u>
<u>720</u>	<u>169</u>	<u>828</u>	<u>138</u>	<u>951</u>	<u>82</u>
<u>721</u>	<u>172</u>	<u>830</u>	<u>139</u>	<u>952</u>	<u>82</u>
<u>722</u>	<u>98</u>	<u>831</u>	<u>143</u>	<u>953</u>	<u>82</u>
<u>723</u>	<u>98</u>	<u>833</u>	<u>140</u>	<u>954</u>	<u>82</u>
<u>725</u>	<u>98</u>	<u>834</u>	<u>97</u>	<u>956</u>	<u>168</u>
<u>726</u>	<u>170</u>	<u>836</u>	<u>143</u>	<u>957</u>	<u>82</u>
<u>727</u>	<u>170</u>	<u>837</u>	<u>142</u>	<u>958</u>	<u>80</u>
<u>729</u>	<u>213</u>	<u>838</u>	<u>140</u>	<u>959</u>	<u>80</u>
<u>730</u>	<u>104</u>	<u>839</u>	<u>140</u>	<u>960</u>	<u>80</u>
<u>730</u>	<u>228</u>	<u>840</u>	<u>139</u>	<u>961</u>	<u>80</u>
<u>731</u>	<u>166</u>	<u>841</u>	<u>138</u>	<u>962</u>	<u>80</u>
<u>732</u>	<u>166</u>	<u>842</u>	<u>139</u>	<u>963</u>	<u>77</u>
<u>736</u>	<u>166</u>	<u>843</u>	<u>135</u>	<u>963GN</u>	<u>77</u>
<u>741</u>	<u>168</u>	<u>843</u>	<u>155</u>	<u>964</u>	<u>77</u>
<u>751</u>	<u>168</u>	<u>843</u>	<u>217</u>	<u>965</u>	<u>77</u>
<u>752</u>	<u>168</u>	<u>844</u>	<u>155</u>	<u>966</u>	<u>77</u>
<u>771</u>	<u>167</u>	<u>846</u>	<u>140</u>	<u>967</u>	<u>77</u>
<u>771</u>	<u>203</u>	<u>847</u>	<u>139</u>	<u>968</u>	<u>81</u>
<u>772</u>	<u>167</u>	<u>848</u>	<u>139</u>	<u>969</u>	<u>81</u>
<u>773</u>	<u>167</u>	<u>848</u>	<u>155</u>	<u>970</u>	<u>81</u>
<u>774</u>	<u>167</u>	<u>849</u>	<u>157</u>	<u>971</u>	<u>81</u>
<u>775</u>	<u>167</u>	<u>851</u>	<u>143</u>	<u>972</u>	<u>84</u>
<u>777</u>	<u>167</u>	<u>852</u>	<u>143</u>	<u>972</u>	<u>216</u>
<u>778</u>	<u>167</u>	<u>856</u>	<u>135</u>	<u>972P</u>	<u>84</u>
<u>779</u>	<u>167</u>	<u>856</u>	<u>217</u>	<u>972P</u>	<u>216</u>
<u>779</u>	<u>168</u>	<u>858</u>	<u>138</u>	<u>973</u>	<u>84</u>
<u>782</u>	<u>166</u>	<u>860</u>	<u>138</u>	<u>973</u>	<u>216</u>
<u>787</u>	<u>125</u>	<u>861</u>	<u>137</u>	<u>973P</u>	<u>84</u>
<u>787</u>	<u>129</u>	<u>862</u>	<u>137</u>	<u>973P</u>	<u>216</u>
<u>788</u>	<u>124</u>	<u>863</u>	<u>97</u>	<u>974</u>	<u>83</u>
<u>788</u>	<u>128</u>	<u>863</u>	<u>137</u>	<u>975</u>	<u>81</u>
<u>789</u>	<u>124</u>	<u>864</u>	<u>97</u>	<u>976</u>	<u>81</u>
<u>789</u>	<u>128</u>	<u>866</u>	<u>144</u>	<u>976C</u>	<u>81</u>
<u>791</u>	<u>115</u>	<u>870</u>	<u>103</u>	<u>976S</u>	<u>81</u>
<u>791</u>	<u>124</u>	<u>871</u>	<u>107</u>	<u>977</u>	<u>78</u>
<u>791</u>	<u>128</u>	<u>886</u>	<u>254</u>	<u>978</u>	<u>79</u>
<u>791</u>	<u>184</u>	<u>888</u>	<u>254</u>	<u>980A</u>	<u>79</u>
<u>791AC</u>	<u>115</u>	<u>891</u>	<u>254</u>	<u>980B</u>	<u>79</u>
<u>791AC</u>	<u>125</u>	<u>892</u>	<u>254</u>	<u>981A</u>	<u>78</u>
<u>791AC</u>	<u>129</u>	<u>899</u>	<u>105</u>	<u>981B</u>	<u>78</u>
<u>791AC</u>	<u>184</u>	<u>899</u>	<u>228</u>	<u>982</u>	<u>82</u>
<u>791E</u>	<u>113</u>	<u>899B</u>	<u>233</u>	<u>983</u>	<u>85</u>
<u>792</u>	<u>124</u>	<u>901</u>	<u>170</u>	<u>984</u>	<u>83</u>
<u>792</u>	<u>128</u>	<u>902</u>	<u>178</u>	<u>985</u>	<u>83</u>
				<u>986</u>	<u>85</u>
				<u>987</u>	<u>85</u>
				<u>988</u>	<u>87</u>
				<u>989</u>	<u>83</u>
				<u>994</u>	<u>97</u>
				<u>994C</u>	<u>173</u>
				<u>995A</u>	<u>85</u>
				<u>995B</u>	<u>85</u>
				<u>996</u>	<u>170</u>
				<u>998</u>	<u>169</u>
				<u>999C</u>	<u>106</u>
				<u>1001</u>	<u>235</u>
				<u>1002</u>	<u>235</u>
				<u>1003</u>	<u>235</u>
				<u>1004</u>	<u>235</u>
				<u>1005</u>	<u>235</u>
				<u>1006</u>	<u>236</u>
				<u>1006</u>	<u>256</u>
				<u>1007</u>	<u>236</u>
				<u>1008</u>	<u>236</u>
				<u>1009</u>	<u>236</u>
				<u>1010</u>	<u>236</u>
				<u>1801</u>	<u>241</u>
				<u>1811</u>	<u>241</u>
				<u>1811</u>	<u>241</u>
				<u>1821</u>	<u>241</u>
				<u>1821</u>	<u>241</u>
				<u>1831</u>	<u>241</u>
				<u>1841</u>	<u>241</u>
				<u>1851</u>	<u>241</u>
				<u>2101</u>	<u>243</u>
				<u>2111</u>	<u>243</u>
				<u>2121</u>	<u>243</u>
				<u>2131</u>	<u>243</u>
				<u>2151</u>	<u>243</u>
				<u>2162</u>	<u>243</u>
				<u>2178</u>	<u>243</u>
				<u>2179</u>	<u>243</u>
				<u>2180</u>	<u>243</u>
				<u>3200</u>	<u>133</u>
				<u>3201</u>	<u>133</u>
				<u>3202</u>	<u>133</u>
				<u>3300</u>	<u>133</u>
				<u>3301</u>	<u>133</u>
				<u>3302</u>	<u>133</u>
				<u>3403</u>	<u>131</u>
				<u>3404</u>	<u>131</u>
				<u>3405</u>	<u>131</u>
				<u>3503</u>	<u>131</u>
				<u>3504</u>	<u>131</u>
				<u>3505</u>	<u>131</u>
				<u>3600</u>	<u>133</u>
				<u>3601</u>	<u>133</u>
				<u>3602</u>	<u>133</u>
				<u>7001B</u>	<u>93</u>
				<u>7002B</u>	<u>93</u>
				<u>7003A</u>	<u>156</u>
				<u>7003B</u>	<u>156</u>
				<u>7004A</u>	<u>93</u>
				<u>7004B</u>	<u>93</u>
				<u>7011</u>	<u>188</u>
				<u>7011</u>	<u>188</u>
				<u>7011E</u>	<u>192</u>
				<u>7011E</u>	<u>188</u>
				<u>7012</u>	<u>192</u>
				<u>7060</u>	<u>89</u>
				<u>7061</u>	<u>144</u>
				<u>7062</u>	<u>144</u>
				<u>7063</u>	<u>144</u>
				<u>7064</u>	<u>144</u>
				<u>7071</u>	<u>89</u>
				<u>7072</u>	<u>89</u>
				<u>7073</u>	<u>89</u>
				<u>7086</u>	<u>198</u>
				<u>7087</u>	<u>198</u>
				<u>7088</u>	<u>198</u>
				<u>7088A</u>	<u>198</u>
				<u>7089</u>	<u>198</u>
				<u>7089A</u>	<u>198</u>
				<u>7090</u>	<u>199</u>
				<u>7092</u>	<u>83</u>
				<u>7092</u>	<u>199</u>
				<u>7093</u>	<u>83</u>
				<u>7093</u>	<u>199</u>
				<u>7094</u>	<u>83</u>
				<u>7094</u>	<u>199</u>
				<u>7199</u>	<u>196</u>
				<u>7199A</u>	<u>196</u>
				<u>7199B</u>	<u>196</u>
				<u>7199C</u>	<u>196</u>
				<u>7201</u>	<u>196</u>
				<u>7201A</u>	<u>196</u>
				<u>7201B</u>	<u>196</u>
				<u>7201C</u>	<u>196</u>
				<u>7204</u>	<u>197</u>
				<u>7206</u>	<u>197</u>
				<u>7208</u>	<u>197</u>
				<u>7999</u>	<u>199</u>
				<u>20705</u>	<u>155</u>
				<u>22004</u>	<u>246</u>
				<u>24202</u>	<u>107</u>
				<u>26202</u>	<u>107</u>
				<u>26203</u>	<u>107</u>
				<u>26204</u>	<u>107</u>
				<u>31802</u>	<u>148</u>
				<u>51610</u>	<u>96</u>
				<u>52922</u>	<u>113</u>
				<u>53706</u>	<u>113</u>
				<u>53706</u>	<u>188</u>
				<u>53706</u>	<u>188</u>
				<u>53712</u>	<u>113</u>
				<u>53712</u>	<u>188</u>
				<u>53712</u>	<u>188</u>
				<u>56022G</u>	<u>119</u>
				<u>56022V</u>	<u>119</u>
				<u>56422G</u>	<u>118</u>
				<u>56422V</u>	<u>118</u>
				<u>58912</u>	<u>248</u>
				<u>58922</u>	<u>248</u>
				<u>58928</u>	<u>248</u>
				<u>58928W</u>	<u>223</u>
				<u>59870</u>	<u>225</u>
				<u>61739B</u>	<u>232</u>
				<u>67301</u>	<u>94</u>
				<u>67301</u>	<u>220</u>
				<u>67304</u>	<u>94</u>
				<u>67304</u>	<u>220</u>
				<u>67701</u>	<u>218</u>
				<u>67704</u>	<u>218</u>
				<u>68702</u>	<u>195</u>
				<u>68703</u>	<





MANIAS
HORECA

MEPRA
S. p. A.